



# PowerLogic®

## Circuit Monitor

### Series 2000

## Reference Manual



# **NOTICE**

Read these instructions carefully and look at the equipment to become familiar with the device before trying to install, operate, or maintain it. The following special messages may appear throughout this bulletin to warn of potential hazards or to call attention to information that clarifies or simplifies a procedure.

## **DANGER**

Used where there is hazard of severe bodily injury or death. Failure to follow a "DANGER" instruction *will* result in *severe* bodily injury or death.

## **WARNING**

Used where there is hazard of bodily injury or death. Failure to follow a "WARNING" instruction can result in bodily injury or death.

## **CAUTION**

Used where there is hazard of equipment damage. Failure to follow a "CAUTION" instruction can result in damage to equipment.

*Note: Provides additional information to clarify or simplify a procedure.*

**PLEASE NOTE:** Electrical equipment should be serviced only by qualified electrical maintenance personnel, and this document should not be viewed as sufficient for those who are not otherwise qualified to operate, service, or maintain the equipment discussed. Although reasonable care has been taken to provide accurate and authoritative information in this document, no responsibility is assumed by Square D for any consequences arising out of the use of this material.

**FCC NOTICE:** This equipment complies with the requirements in Part 15 of FCC rules for a Class A computing device. Operation of this equipment in a residential area may cause unacceptable interference to radio and TV reception, requiring the operator to take whatever steps are necessary to correct the interference.

## **TECHNICAL SUPPORT**

**For technical support, contact the Power Management Operation Technical Support Center. Hours are 7:30 A.M. to 4:30 P.M., Central Time, Monday through Friday.**

**Phone: (615) 287-3400**

**Fax: (615) 287-3404**

**BBS: (615) 287-3414**

**Email: [PMOSUPRT@SquareD.com](mailto:PMOSUPRT@SquareD.com)**

POWERLOGIC, SY/MAX, SY/NET, SY/LINK, POWER-ZONE, VISI-VAC, ISO-FLEX and  are Registered Trademarks of Square D Company. SYSTEM MANAGER and CIRCUIT TRACKER are Trademarks of Square D Company.

Windows, Windows NT, and Windows 95 are Registered Trademarks of Microsoft Corporation. Other names are trademarks or service marks of their respective companies.

Please fill out, detach, and mail the postage paid card below. Fill out only one registration card, even if you have purchased multiple POWERLOGIC devices.

## Registration Card

**Register your POWERLOGIC OR POWERLINK product today and get:**

- Free expert technical phone support—just call (615) 287-3400
- Notice of product upgrades and new product releases
- Notice of special product offers and price discounts

Name \_\_\_\_\_ Dept./Title \_\_\_\_\_

Company \_\_\_\_\_

Mailing Address \_\_\_\_\_

City \_\_\_\_\_ State \_\_\_\_\_ Country \_\_\_\_\_

Zip/Postal Code \_\_\_\_\_ Email Address \_\_\_\_\_

Telephone \_\_\_\_\_ Fax \_\_\_\_\_

Product Purchased Through (Distributor) \_\_\_\_\_

**Please tell us how many of each of the following products you have:**

Circuit Monitors:  1–5     6–20     21–50     51–100     100+

Power Meters:  1–5     6–20     21–50     51–100     100+

**Are you interested in receiving information on POWERLOGIC Application Software?**

Yes     No



NO POSTAGE  
NECESSARY  
IF MAILED  
IN THE  
UNITED STATES

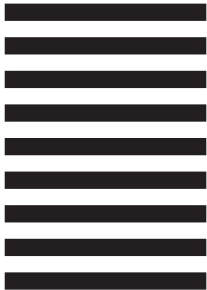

**BUSINESS REPLY MAIL**

FIRST CLASS MAIL PERMIT NO. 635 PALATINE, IL

POSTAGE WILL BE PAID BY ADDRESSEE

SQUARE D COMPANY  
295 TECH PARK DR STE 100  
LA VERGNE, TN 37086-9908



**CONTENTS**

**CHAPTER 1—INTRODUCTION ..... 1**

- What is the Circuit Monitor? ..... 1
- Expanded Memory ..... 3
  - Requirements for Using ..... 4
  - Identifying the Series and Firmware Revisions ..... 4
  - Model Numbers ..... 4
  - Upgrading Existing Circuit Monitors ..... 5
  - Memory Options Summary ..... 5
- Safety Precautions ..... 6
- Using This Bulletin ..... 6
  - Notational Conventions ..... 6
  - Topics Not Covered Here ..... 7
- Related Documents ..... 7
  - Fax-On-Demand ..... 7
  - Installation and Operation Bulletin ..... 8

**CHAPTER 2—METERING CAPABILITIES ..... 9**

- Real-Time Readings ..... 9
  - Min/Max Values ..... 10
- Demand Readings ..... 12
  - Demand Power Calculation Methods ..... 12
  - Predicted Demand ..... 13
  - Peak Demand ..... 13
  - Generic Demand ..... 14
  - Voltage Demand ..... 14
- Energy Readings ..... 14
- Power Analysis Values ..... 15

**CHAPTER 3—INPUT/OUTPUT CAPABILITIES ..... 17**

- Input/Output Modules ..... 17
- Status Inputs ..... 18
- Demand Synch Pulse Input ..... 19
- Analog Inputs ..... 20
  - Analog Input Example ..... 21
- Relay Output Operating Modes ..... 22
- Mechanical Relay Outputs ..... 24
  - Setpoint Controlled Relay Functions ..... 25
- Solid-State KYZ Pulse Output ..... 26
  - 2-Wire Pulse Initiator ..... 26
  - 3-Wire Pulse Initiator ..... 27
  - Calculating the Watthour-Per-Pulse Value ..... 28
- Analog Outputs ..... 29
  - Analog Output Example ..... 30



Setting Up Relays for Remote (External) Control .....	64
Energizing a Relay .....	64
De-Energizing a Relay .....	64
Setting Up Relays for Circuit Monitor (Internal) Control .....	65
Overriding an Output Relay .....	65
Releasing an Overridden Relay .....	65
Setting Scale Factors For Extended Metering Ranges .....	66
Setting The Date and Time Using the Command Interface .....	69
Memory Allocation .....	69
Memory Example .....	71
How Power Factor is Stored .....	71
Changing the VAR Sign Convention .....	72
Conditional Energy .....	73
Command Interface Control .....	73
Status Input Control .....	73
Incremental Energy .....	74
Using Incremental Energy .....	74
Changing the Demand Calculation Method .....	75
Changing to the Block/Rolling Method .....	75
Setting Up a Demand Synch Pulse Input .....	75
Controlling the Demand Interval Over the Communications Link .....	76
Setting Up Individual Harmonic Calculations .....	77
Status Input Pulse Demand Metering .....	78
Pulse Counting Example .....	78

**APPENDICES**

Appendix A—Communication Cable Pinouts .....	81
Appendix B—Abbreviated Register Listing .....	83
Appendix C—Calculating Log File Sizes .....	115
Appendix D—Alarm Setup Information .....	117
Appendix E—Reading and Writing Registers from the Front Panel .....	125

**FIGURES**

1-1 Circuit monitor series/firmware revision sticker .....	4
2-1 Power factor min/max example .....	11
2-2 Default VAR sign convention .....	11
2-3 Alternate VAR sign convention .....	11
3-1 Demand synch pulse timing .....	19
3-2 Analog input example .....	21
3-3 2-wire pulse train .....	27
3-4 3-wire pulse train .....	27
3-5 Analog output example .....	30
4-1 Sample event log entry .....	32
4-2 How the circuit monitor handles setpoint-driven alarms .....	32
6-1 Flowchart illustrating automatic waveform capture .....	42
6-2 Status input S2 connected to external high-speed relay .....	45

6-3	12-cycle event capture example initiated from a high-speed input S2 .....	46
7-1	A fault near plant D that is cleared by the utility circuit breaker can still affect plants A, B, and C, resulting in a voltage sag .....	50
7-2	Voltage sag caused by a remote fault and lasting 5 cycles .....	50
7-3	POWERLOGIC System Manager SMS-3000 Onboard Data Storage dialog box .....	53
7-4	POWERLOGIC System Manager SMS-770 Onboard Data Storage setup dialog box .....	54
7-5	60-cycle extended event capture displayed in SMS-3000 .....	56
7-6	Three back-to-back 12-cycle waveform captures of a $V_{a-n}$ sag .....	56
7-7	High-speed event log entries .....	57
9-1	Memory allocation example (CM-2350) .....	70
9-2	Power factor register format .....	71
9-3	Default VAR sign convention .....	72
9-4	Optional VAR sign convention .....	72
9-5	Pulse demand metering example .....	79

**TABLES**

1-1	Summary of circuit monitor instrumentation .....	3
1-2	Class 3020 circuit monitors .....	3
1-3	Circuit monitor feature comparison .....	3
1-4	Circuit monitor model numbers .....	4
1-5	Memory upgrade kit part numbers .....	5
1-6	Series 2000 circuit monitor memory options .....	5
2-1	Real-time readings .....	9
2-2	Demand readings .....	12
2-3	Energy readings .....	14
2-4	Power analysis values .....	16
3-1	Input/Output Modules .....	17
5-1	Values stored in maintenance log .....	40
7-1	Circuit monitor electromagnetic phenomena measurement capability .....	51
7-2	Multiple 12-cycle waveform capture .....	54
7-3	CM-2350 and CM-2450 12-cycle waveform capture memory allocation .....	55
7-4	CM-2452 12-cycle waveform capture memory allocation .....	55
9-1	Memory configuration example .....	71



## CHAPTER 1—INTRODUCTION

### CHAPTER CONTENTS

This chapter offers a general description of the circuit monitor, describes important safety precautions, tells how to best use this bulletin, and lists related documents. Topics are discussed in the following order:

What is the Circuit Monitor? .....	1
Expanded Memory .....	3
Requirements for Using .....	4
Identifying the Series and Firmware Revisions .....	4
Model Numbers .....	4
Upgrading Existing Circuit Monitors .....	5
Memory Options Summary .....	5
Safety Precautions .....	6
Using This Bulletin .....	6
Notational Conventions .....	6
Topics Not Covered Here .....	7
Related Documents .....	7
Fax-On-Demand .....	7
Installation and Operation Bulletin .....	8

*Note: This edition of the circuit monitor instruction bulletin describes features available in series G4 or later and firmware version 17.009 (or higher). Series 2000 circuit monitors with older series numbers or firmware versions will not include all features described in this instruction bulletin. If you have Series 2000 circuit monitors that do not have the latest firmware version and you want to upgrade their firmware, contact your local Square D representative for information on purchasing the Class 3020 Type CM-2000U Circuit Monitor Firmware Upgrade Kit.*

### WHAT IS THE CIRCUIT MONITOR?

The POWERLOGIC® Circuit Monitor is a multifunction, digital instrumentation, data acquisition and control device. It can replace a variety of meters, relays, transducers and other components. The circuit monitor is equipped with RS-485 communications for integration into any power monitoring and control system. However, POWERLOGIC System Manager application software—written specifically for power monitoring and control—best supports the circuit monitor’s advanced features.

The circuit monitor is a true rms meter capable of exceptionally accurate measurement of highly nonlinear loads. A sophisticated sampling technique enables accurate, true rms measurement through the 31st harmonic. Over 50 metered values plus extensive minimum and maximum data can be viewed from the six-digit LED display. Table 1-1 on page 3 provides a summary of circuit monitor instrumentation.

The circuit monitor is available in several models to meet a broad range of power monitoring and control applications. Table 1-2 on page 3 lists the circuit monitor models. Table 1-3 compares the features available by model.

Circuit monitor capabilities can be expanded using add-on modules that mount on the back of the circuit monitor. A voltage/power module and several input/output modules are available. See **Input/Output Capabilities** in Chapter 3 for a description of the available I/O modules.

**What is the Circuit Monitor?  
(cont.)**

Using POWERLOGIC application software, users can upgrade circuit monitor firmware through either the RS-485 or front panel optical communications ports. This feature can be used to keep all circuit monitors up to date with the latest system enhancements.

Some of the circuit monitor's many features include:

- True rms metering (31st harmonic)
- Accepts standard CT and PT inputs
- Certified ANSI C12.16 revenue accuracy
- High accuracy—0.2% current and voltage
- Over 50 displayed meter values
- Min/Max displays for metered data
- Power quality readings—THD, K-factor, crest factor
- Real time harmonic magnitudes and angles
- Current and voltage sag/swell detection and recording
- On-board clock/calendar
- Easy front panel setup (password protected)
- RS-485 communications standard
- Front panel, RS-232 optical communications port standard
- Modular, field-installable analog and digital I/O
- 1 ms time stamping of status inputs for sequence-of-events recording
- I/O modules support programmable KYZ pulse output
- Setpoint-controlled alarm/relay functions
- On-board event and data logging
- Waveform and event captures, user-selectable for 4, 12, 36, 48, or 60 cycles
- 64 and 128 point/cycle waveform captures
- High-speed, triggered event capture
- Programming language for application specific solutions
- Downloadable firmware
- System connections
  - 3-phase, 3-wire Delta
  - 3-phase, 4-wire Wye
  - Metered or calculated neutral
  - Other metering connections
- Optional voltage/power module for direct connection to 480Y/277V
- Optional control power module for connecting to 18–60 Vdc control power
- Wide operating temperature range standard (-25 to +70°C)
- UL Listed, CSA certified, and CE marked
- MV-90™ billing compatible
- Pre-configured data log and alarms

**Table 1-1**  
**Summary of Circuit Monitor Instrumentation**

Real-Time Readings	Energy Readings
<ul style="list-style-type: none"> <li>• Current (per phase, N, G, 3Ø)</li> <li>• Voltage (L-L, L-N)</li> <li>• Real Power (per phase, 3Ø)</li> <li>• Reactive Power (per phase, 3Ø)</li> <li>• Apparent Power (per phase, 3Ø)</li> <li>• Power Factor (per phase, 3Ø)</li> <li>• Frequency</li> <li>• Temperature (internal ambient)*</li> <li>• THD (current and voltage)</li> <li>• K-Factor (per phase)</li> </ul>	<ul style="list-style-type: none"> <li>• Accumulated Energy, Real</li> <li>• Accumulated Energy, Reactive</li> <li>• Accumulated Energy, Apparent*</li> <li>• Bidirectional Readings*</li> </ul>
	Power Analysis Values*
	<ul style="list-style-type: none"> <li>• Crest Factor (per phase)</li> <li>• K-Factor Demand (per phase)</li> <li>• Displacement Power Factor (per phase, 3Ø)</li> <li>• Fundamental Voltages (per phase)</li> <li>• Fundamental Currents (per phase)</li> <li>• Fundamental Real Power (per phase)</li> <li>• Fundamental Reactive Power (per phase)</li> <li>• Harmonic Power</li> <li>• Unbalance (current and voltage)</li> <li>• Phase Rotation</li> <li>• Harmonic Magnitudes &amp; Angles (per phase)</li> </ul>
Demand Readings	
<ul style="list-style-type: none"> <li>• Demand Current (per-phase present, peak)</li> <li>• Demand Voltage (per-phase present, peak)*</li> <li>• Average Power Factor (3Ø total)*</li> <li>• Demand Real Power (3Ø total)</li> <li>• Demand Reactive Power (3Ø total)*</li> <li>• Demand Apparent Power (3Ø total)</li> <li>• Coincident Readings*</li> <li>• Predicted Demands*</li> </ul>	
	* Available via communications only.

**Table 1-2**  
**Class 3020 Circuit Monitors**

Type	Description
CM-2050	Instrumentation, 1% accuracy
CM-2150	Instrumentation, 0.2% accuracy, data logging, alarm/relay functions
CM-2250	Waveform capture, plus CM-2150 features
CM-2350	Instrumentation, waveform capture, 0.2% accuracy
CM-2450	Programmable for custom applications, plus-2350 features

**Table 1-3**  
**Circuit Monitor Feature Comparison**

Feature	CM-2050	CM-2150	CM-2250	CM-2350	CM-2450
Full Instrumentation	X	X	X	X	X
RS-485 Comm Port	X	X	X	X	X
Front Panel Optical Comm Port	X	X	X	X	X
1% Accuracy Class	X				
0.2% Accuracy Class		X	X	X	X
Alarm/Relay Functions		X	X	X	X
On-board Data Logging		X	X	X	X
Downloadable Firmware		X	X	X	X
Date/Time for Each Min/Max		X	X	X	X
Waveform Capture			X	X	X
Extended Event Capture			X	X	X
Extended Memory (up to 1.1 Meg.)*		X	X	X	X
Sag/Swell Detection				X	X
Programmable for Custom Applications					X

\* Standard memory: CM-2150, CM-2250, CM-2350, and CM-2450 = 100K; CM-2452 = 356K

## EXPANDED MEMORY

New Series G4 (or higher) circuit monitor models CM-2150 and higher now are factory-equipped with 100 kilobytes (100K) of nonvolatile memory. (Earlier Series G3 models CM-2150 and CM-2250 shipped with 11K of memory, models CM-2350 and CM-2450 with 100K of memory.)

**EXPANDED MEMORY (cont.)** For applications where additional memory is required, you can order a circuit monitor with an optional 512K or 1024K memory expansion card, resulting in 612K or 1124K, respectively, total nonvolatile memory (100K base memory plus the expansion card memory). Memory upgrade kits are also available for most earlier circuit monitors. See **Upgrading Existing Circuit Monitors**, page 5.

**Requirements for Using Expanded Memory**

System Manager software version 3.02 with Service Update 1, 3.02a with Service Update 1, or 3.1 (or higher) is required to take advantage of expansion card memory or the 100K of memory standard on G4 circuit monitors. Earlier versions of System Manager software will recognize only 11K (the Series G3 and earlier memory capacity) of available memory.

Also, your circuit monitor must be equipped with firmware version 17.009 or later to take advantage of expanded memory. The following section tells how to determine the firmware version shipped with your circuit monitor.

To determine if your circuit monitor firmware version has been updated with downloadable firmware, see **Viewing Configuration Data in Protected Mode** in **Chapter 4** of the *Circuit Monitor Installation and Operation Bulletin*.

To obtain the latest available firmware revision contact your local Square D representative (see *Note*, page 1.)

**Identifying the Series and Firmware Revisions**

The circuit monitor series and firmware revision numbers are printed on a sticker on the top of the circuit monitor enclosure. Figure 1-1 shows a sample sticker.



*Figure 1-1: Circuit monitor series/firmware revision sticker*

**Model Numbers**

Circuit monitor models equipped with an optional memory expansion card are differentiated from standard models by a suffix—either -512k or -1024k—added to the model number (table 1-4). As shown in the table, the memory expansion option is available for model numbers CM-2150, CM-2250, CM-2350, and CM-2450. The CM-2452 circuit monitor is now obsolete and has been replaced by the CM-2450-512k, which has more memory at a lower price than the CM-2452. However, existing CM-2452 circuit monitors can be upgraded as detailed on the following page.

**Table 1-4  
Circuit Monitor Model Numbers**

Standard Models	Models with 512k Option	Models with 1024k Option
3020 CM-2050	N/A	N/A
3020 CM-2150	3020 CM-2150-512k	3020 CM-2150-1024k
3020 CM-2250	3020 CM-2250-512k	3020 CM-2250-1024k
3020 CM-2350	3020 CM-2350-512k	3020 CM-2350-1024k
3020 CM-2450	3020 CM-2450-512k	3020 CM-2450-1024k

## Upgrading Existing Circuit Monitors

Memory upgrade kits are available for field installation by a qualified electrician. No special tools are required.

### DANGER

#### HAZARD OF ELECTRIC SHOCK, BURN, OR EXPLOSION

Only qualified electrical workers should install a memory upgrade kit in a circuit monitor. Perform the upgrade only after reading the installation instructions shipped with the upgrade kit. Before removing the cover of the circuit monitor to install the memory board:

- Disconnect all voltage inputs to the circuit monitor
- Short the CT secondaries
- De-energize the control power inputs

**Failure to observe this precaution will result in death or serious injury.**

For Series G3 and earlier circuit monitors, the memory upgrade kit can be installed only in circuit monitor models CM-2350 and CM-2450.

*Note: Model CM-2452 was factory-equipped with 100K of memory and a 256K memory expansion card, for a total of 356K of memory. The 256K card can be removed and replaced with a 512K or 1024K expansion card, for total memory of either 612K or 1124K.*

The memory upgrade kit can be installed in Series G4 models CM-2150 and higher. Memory upgrade kits are available with either the 512k or 1024k memory card (see table 1-5). No special tools are required for installation.

**Table 1-5**  
Memory Upgrade Kit Part Numbers

Part Number	Description
3020 CM-MEM-512K	512K Memory Upgrade Kit for Series 2000 Circuit Monitors
3020 CM-MEM-1024K	1024K Memory Upgrade Kit for Series 2000 Circuit Monitors

## Memory Options Summary

Table 1-6 summarizes the memory options now available for Series 2000 Circuit Monitors. To obtain price and availability on circuit monitors with expanded memory and circuit monitor memory upgrade kits, contact your local sales representative.

**Table 1-6**  
Series 2000 Circuit Monitor Memory Options

Model Number	Total Memory Capacity					
	Series G3 or Earlier			Series G4 or Later		
	Standard	512K Expansion	1024K Expansion	Standard	512K Expansion	1024K Expansion
CM-2050	N/A	N/A	N/A	N/A	N/A	N/A
CM-2150	11K	N/A	N/A	100K	612K	1124K
CM-2250	11K	N/A	N/A	100K	612K	1124K
CM-2350	100K	612K	1124K	100K	612K	1124K
CM-2450	100K	612K	1124K	100K	612K	1124K
CM-2452	356K	612K ①	1124K ①	Obsolete		

① CM-2452 256K memory expansion card removed and replaced with 512K or 1024K memory expansion card.

## SAFETY PRECAUTIONS

### **DANGER**

#### HAZARD OF BODILY INJURY OR EQUIPMENT DAMAGE

- Only qualified electrical workers should install this equipment. Such work should be performed only after reading this entire set of instructions.
- The successful operation of this equipment depends upon proper handling, installation, and operation. Neglecting fundamental installation requirements may lead to personal injury as well as damage to electrical equipment or other property.
- Before performing visual inspections, tests, or maintenance on this equipment, disconnect all sources of electric power. Assume that all circuits are live until they have been completely de-energized, tested, grounded, and tagged. Pay particular attention to the design of the power system. Consider all sources of power, including the possibility of backfeeding.

**Failure to observe this precaution will result in death, serious injury, or equipment damage.**

## USING THIS BULLETIN

This document provides information on the circuit monitor's general to advanced features. The document consists of a table of contents, nine chapters, and several appendices. Chapters longer than a few pages begin with a chapter table of contents. To locate information on a specific topic, refer to the table of contents at the beginning of the document, or the table of contents at the beginning of a specific chapter.

## Notational Conventions

This document uses the following notational conventions:

- **Procedures.** Each procedure begins with an italicized statement of the task, followed by a numbered list of steps. Procedures require you to take action.
- **Bullets.** Bulleted lists, such as this one, provide information but not procedural steps. They do not require you to take action.
- **Cross-References.** Cross-references to other sections in the document appear in boldface. Example: see **Analog Inputs** in **Chapter 3**.

**Topics Not Covered Here**

This bulletin does not describe the installation and operation of the circuit monitor. For these instructions, see the *Circuit Monitor Installation and Operation Bulletin* (No. 3020IM9807). Some of the circuit monitor's advanced features, such as on-board data log and event log files, must be set up over the communications link using POWERLOGIC application software. This bulletin describes these advanced features, but it does not tell how to set them up. For instructions on setting up these advanced features, refer to the appropriate application software instruction bulletin listed below.

Computer Operating System	Software	Instruction Bulletin Order No.
Windows NT®	SMS-3000 System Administrator's Guide (client/server)	3080IM9602
Windows NT®	SMS-3000 User's Manual (client/server)	3080IM9601
Windows NT/Windows® 95	System Manager Standalone (SMS-1500/PMX-1500/SMS-121)	3080IM9702
Windows 3.1	SMS-770/700	3080IM9305
Windows 3.1	EXP-550/500	3080IM9501
DOS	PSW-101	3080IM9302

**RELATED DOCUMENTS**

Several optional add-on modules are available for use with the circuit monitor. Each module is shipped with an instruction bulletin detailing installation and use of the product. Available add-on modules for the circuit monitor are listed below.

Instruction Bulletin Title	Reference No. <sup>①</sup>
• POWERLOGIC Control Power Module (CPM-48)	3090IM9305
• POWERLOGIC Ride-Through Module	3090IM9701
• I/O Modules (IOM-11/44/18)	3020IM9304
• I/O Modules (IOM-4411/4444)	3020IM9401
• Voltage/Power Module	3090IM9302
• Optical Communications Interface (OCI-2000)	3090IM9303
• Ethernet Communications Module (ECM-2000/ECM-RM)	3020IB9818

**Fax-On-Demand**

In addition, the software and add-on module instruction bulletins listed in this chapter are available through D-Fax, the Square D fax-on-demand system. Phone 1-800-557-4556<sup>②</sup> and request a POWERLOGIC/Power Monitoring index. Then call back and order the document(s) you want by specifying the Fax Document Number(s) from the index. The document(s) will be faxed to your fax machine. This service is accessible seven days a week, 24 hours a day.

<sup>①</sup> Reference numbers listed are the original document numbers. If a document has been revised, the listed number will be followed by a revision number, for example R10/97.

<sup>②</sup> In some instances, this toll-free number may not work if dialed from outside of the United States. In such instances, phone 1-919-217-6344 to speak to the D-Fax administrator.

**Installation and Operation  
Bulletin**

For information necessary to install and operate the circuit monitor, see the *POWERLOGIC Circuit Monitor Installation and Operation Bulletin* (No. 3020IM9807), which includes information on the following topics:

- Hardware Description
- Mounting and Grounding the Circuit Monitor
- Wiring CTs, PTs, and Control Power
- Communications Wiring
- Configuring the Circuit Monitor
- Setting up Alarm/Relay Functions
- Viewing Active Alarms
- Circuit Monitor Dimensions
- Specifications
- Installing Terminal Strip Covers

The installation and operation manual is included with each circuit monitor. Additional copies can be obtained the following two ways:

- Download an electronic version (Acrobat PDF format) from the POWERLOGIC web site at [www.powerlogic.com](http://www.powerlogic.com).
- Order a printed copy from the Square D Literature Center at 1-800-888-2448. Ask for document #3020IM9807.



## CHAPTER 2—METERING CAPABILITIES

### CHAPTER CONTENTS

Real-Time Readings .....	9
Min/Max Values .....	10
Demand Readings .....	12
Demand Power Calculation Methods .....	12
Predicted Demand .....	13
Peak Demand .....	13
Generic Demand .....	14
Energy Readings .....	14
Power Analysis Values .....	15

### REAL-TIME READINGS

The circuit monitor measures currents and voltages and reports rms values for all three phases and neutral/ground current. In addition, the circuit monitor calculates power factor, real power, reactive power, and more. Table 2-1 lists the real-time readings and their reportable ranges.

**Table 2-1**  
**Real-Time Readings**

Real-Time Reading	Reportable Range
<b>Current</b>	
Per-Phase	0 to 32,767 A
Neutral	0 to 32,767 A
Ground ①	0 to 32,767 A
3-Phase Average	0 to 32,767 A
Apparent rms ①	0 to 32,767 A
Current Unbalance ①	0 to 100%
<b>Voltage</b>	
Line-to-Line, Per-Phase	0 to 3,276,700 V
Line-to-Neutral, Per-Phase	0 to 3,276,700 V
3-Phase Average	0 to 3,276,700 V
Voltage Unbalance ①	0 to 100%
<b>Real Power</b>	
3-Phase Total	0 to +/- 3,276.70 MW
Per-Phase	0 to +/- 3,276.70 MW
<b>Reactive Power</b>	
3-Phase Total	0 to +/- 3,276.70 MVAr
Per-Phase	0 to +/- 3,276.70 MVAr
<b>Apparent Power</b>	
3-Phase Total	0 to 3,276.70 MVA
Per-Phase	0 to 3,276.70 MVA
<b>Power Factor (True)</b>	
3-Phase Total	-0.010 to 1.000 to +0.010
Per-Phase	-0.010 to 1.000 to +0.010
<b>Power Factor (Displacement)</b>	
3-Phase Total ①	-0.010 to 1.000 to +0.010
Per-Phase ①	-0.010 to 1.000 to +0.010
<b>Frequency</b>	
50/60 Hz	23.00 to 67.00 Hz
400 Hz	350.00 to 450.00 Hz
Temperature (Internal Ambient) ①	-100.00°C to +100.00°C

① Via communications only.

## Min/Max Values

The circuit monitor stores minimum and maximum values for all real-time readings in nonvolatile memory. In addition, the circuit monitor (except model CM-2050) stores the date and time associated with each minimum and each maximum.

Minimums and maximums for front panel values can be viewed on the circuit monitor's LED display. All min/max values—including those not displayable from the front panel—can be reset from the circuit monitor's front panel. See **Resetting Demand, Energy and Min/Max Values in Chapter 4** of the *Circuit Monitor Installation and Operation Bulletin* for reset instructions.

Using POWERLOGIC application software you can:

- View all min/max values and their associated dates and times
- Upload min/max values—and their associated dates and times—from the circuit monitor and save them to disk
- Reset all min/max values

For instructions on viewing, saving, and resetting min/max data using POWERLOGIC software, refer to the instruction bulletin included with the software.

## Power Factor Min/Max Conventions

All running min/max values, with the exception of power factor, are arithmetic minimums and maximums. For example, the minimum phase A-B voltage is simply the lowest value in the range 0 to 3,276,700 V that has occurred since the min/max values were last reset. In contrast, power factor min/max values—since the meter's midpoint is unity—are not true arithmetic minimums and maximums. Instead, the minimum value represents the measurement closest to -0 on a continuous scale of -0 to 1.00 to +0. The maximum value is the measurement closest to +0 on the same scale.

Figure 2-1 shows the min/max values in a typical environment, assuming a positive power flow. In figure 2-1, the minimum power factor is -.7 (lagging) and the maximum is .8 (leading). It is important to note that the minimum power factor need not be lagging, and the maximum power factor need not be leading. For example, if the power factor values ranged from -.75 to -.95, then the minimum power factor would be -.75 (lagging) and the maximum power factor would be -.95 (lagging). Likewise, if the power factor ranged from +.9 to +.95, the minimum would be +.95 (leading) and the maximum would be +.90 (leading).

See **Changing the VAR Sign Convention in Chapter 9** for instructions on changing the sign convention over the communications link.

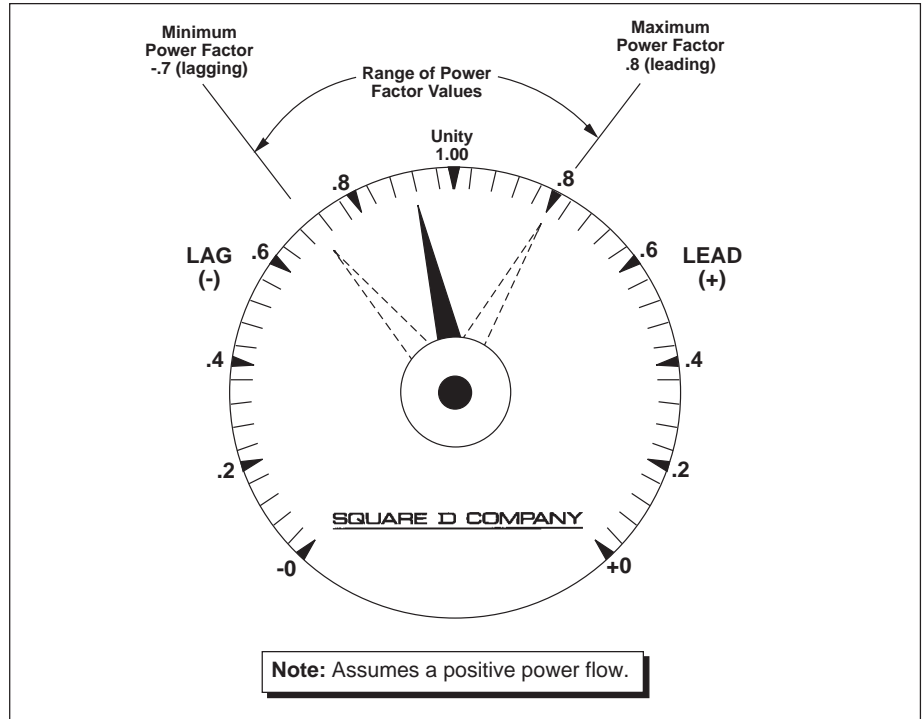

Figure 2-1: Power factor min/max example

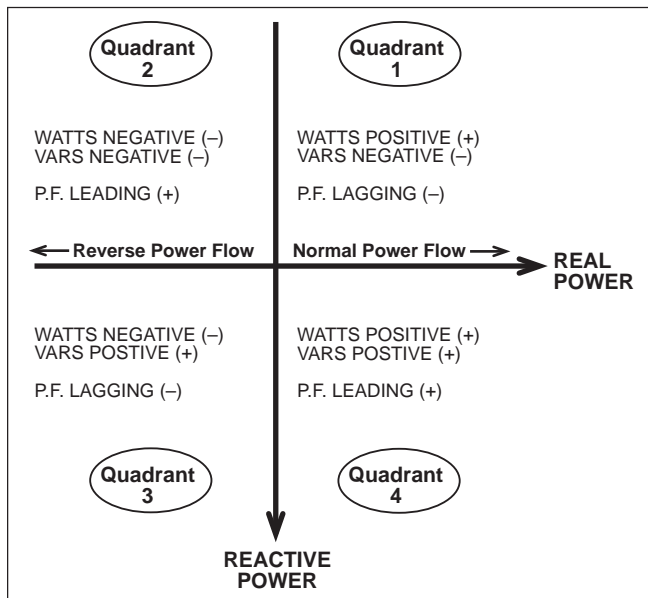

Figure 2-2: Default VAR sign convention

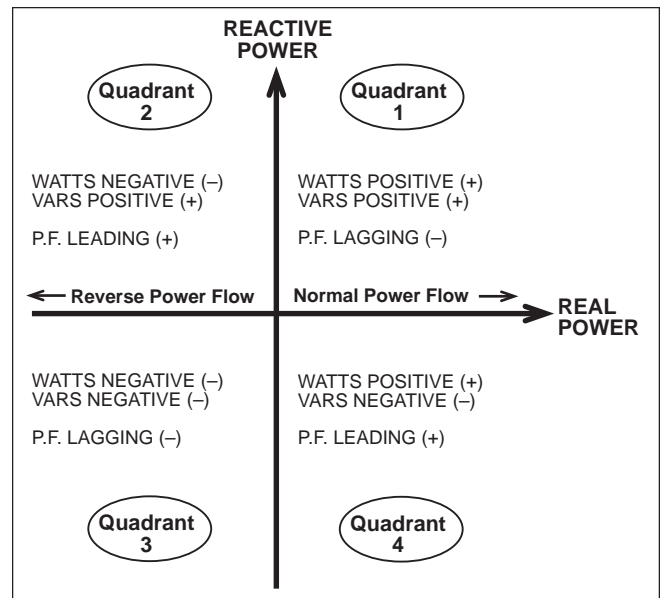

Figure 2-3: Alternate VAR sign convention

**DEMAND READINGS**

The circuit monitor provides a variety of demand readings, including coincident readings and predicted demands. Table 2-2 lists the available demand readings and their reportable ranges.

**Table 2-2  
Demand Readings**

Demand Reading	Reportable Range
Demand Current, Per-Phase, 3Ø Avg., Neutral	
Present	0 to 32,767 A
Peak	0 to 32,767 A
Demand Voltage, Per-phase & 3Ø Avg. L-N, L-L	
Present	0 to 32,767 V
Minimum	0 to 32,767 V
Peak	0 to 32,767 V
Avg. Power Factor (True), 3Ø Total	
Present ①	-0.010 to 1.000 to +0.010
Coincident w/ kW Peak ①	-0.010 to 1.000 to +0.010
Coincident w/ kVAR Peak ①	-0.010 to 1.000 to +0.010
Coincident w/ kVA Peak ①	-0.010 to 1.000 to +0.010
Demand Real Power, 3Ø Total	
Present	0 to +/-3,276.70 MW
Predicted ①	0 to +/-3,276.70 MW
Peak	0 to +/-3,276.70 MW
Coincident kVA Demand ①	0 to 3,276.70 MVA
Coincident kVAR Demand ①	0 to +/-3,276.70 MVAR
Demand Reactive Power, 3Ø Total	
Present	0 to +/-3,276.70 MVAR
Predicted ①	0 to +/-3,276.70 MVAR
Peak	0 to +/-3,276.70 MVAR
Coincident kVA Demand ①	0 to 3,276.70 MVA
Coincident kW Demand ①	0 to +/-3,276.70 MW
Demand Apparent Power, 3Ø Total	
Present	0 to 3,276.70 MVA
Predicted ①	0 to 3,276.70 MVA
Peak	0 to 3,276.70 MVA
Coincident kW Demand ①	0 to +/-3,276.70 MW
Coincident kVAR Demand ①	0 to +/-3,276.70 MVAR

① Via communications only.

**Demand Power  
Calculation Methods**

To be compatible with electric utility billing practices, the circuit monitor provides the following types of demand power calculations:

- Thermal Demand
- Block Interval Demand with Rolling Sub-Interval
- External Pulse Synchronized Demand

The default demand calculation method is Thermal Demand. The Thermal Demand Method and the External Synch Pulse method can be set up from the circuit monitor faceplate. (See **Setting the Demand Interval** in **Chapter 4** of the *Circuit Monitor Installation and Operation Bulletin* for setup instructions.) Other demand calculation methods can be set up over the communications link. A brief description of each demand method follows.

### Demand Power Calculation Methods (cont.)

#### Thermal Demand:

The thermal demand method calculates the demand based on a thermal response and updates its demand calculation every 15 seconds on a sliding window basis. The user can select the demand interval from 5 to 60 minutes in 5 minute increments. See **Setting the Demand Interval** in **Chapter 4** of the *Circuit Monitor Installation and Operation Bulletin* for instructions.

#### Block Interval Demand:

The block interval demand mode supports a standard block interval and an optional subinterval calculation for compatibility with electric utility electronic demand registers.

In the standard block interval mode, the user can select a demand interval from 5 to 60 minutes in 5-minute increments. (See **Setting the Demand Interval** in **Chapter 4** of the *Circuit Monitor Installation and Operation Bulletin* for instructions.) The demand calculation is performed at the end of each interval. The present demand value displayed by the circuit monitor is the value for the last completed demand interval.

#### Block Interval Demand with Sub-Interval Option:

When using the block interval method, a demand subinterval can be defined. The user must select both a block interval and a subinterval length. The block interval must be divisible by an integer number of subintervals. (A common selection would be a 15-minute block interval with three 5-minute subintervals.) The block interval demand is recalculated at the end of every subinterval. If the user programs a subinterval of 0, the demand calculation updates every 15 seconds on a sliding window basis.

#### External Pulse Synchronized Demand:

The circuit monitor can be configured to accept—through status input S1—a demand synch pulse from another meter. The circuit monitor then uses the same time interval as the other meter for each demand calculation. See **Demand Synch Pulse Input** in **Chapter 3** for additional details.

### Predicted Demand

The circuit monitor calculates predicted demand for kW, kVA<sub>r</sub>, and kVA. The predicted demand is equal to the average power over a one-minute interval. The predicted demand is updated every 15 seconds.

### Peak Demand

The circuit monitor maintains, in nonvolatile memory, a running maximum—called “peak demand”—for each average demand current and average demand power value. It also stores the date and time of each peak demand. In addition to the peak demand, the circuit monitor stores the coinciding average (demand) 3-phase power factor. The average 3-phase power factor is defined as “demand kW/demand kVA” for the peak demand interval.

Peak demand values can be reset from the circuit monitor front panel, or over the communications link using POWERLOGIC application software. To reset peak demand values from the circuit monitor front panel, see **Resetting Demand, Energy, and Min/Max Values** in **Chapter 4** of the *Circuit Monitor Installation and Operation Bulletin*.

## Generic Demand

The circuit monitor has the capability to perform a thermal demand calculation on 20 user-specified quantities. The user can select the demand interval from 5–60 minutes in 5-minute increments. For each quantity, the present, minimum, and maximum demand values are stored. The date and time of the minimums and maximums for the first ten demand quantities are also stored.

To set up the demand calculation for a specific quantity, write the corresponding register number for that quantity in the register range of 2205–2224. The generic demand interval can be configured by writing the desired interval in register 2201. (For a complete list of all registers and their descriptions pertaining to generic demand, see the register list in Appendix B, beginning with register number 2200. For instructions on reading and writing to registers, see the software instruction manual.)

Minimum and maximum generic demand values can be reset by using POWERLOGIC application software. The minimum and maximum values can be reset by resetting the peak current demand values or through the command interface using command 5112 (see **Command Interface** in **Chapter 9**). Command 5112 will reset only the generic demand minimums and maximums.

## Voltage Demand

The circuit monitor is pre-configured to perform a demand calculation on voltage using the generic demand capability. Generic demand registers 2230–2253 automatically contain the values of the present voltage demand values, along with the corresponding minimums and maximums. The date and time for the minimum and peak voltage demands are located in registers 1900–1941. These quantities can be viewed using POWERLOGIC application software.

## ENERGY READINGS

The circuit monitor provides energy values for kWh and kVARh, which can be displayed on the circuit monitor, or read over the communications link.

**Table 2-3**  
**Energy Readings**

Energy Reading, 3-Phase	Reportable Range ①	Reportable Front Panel	Front Panel Display ②
Accumulated Energy Real (Signed/Absolute) Reactive (Signed/Absolute)	0 to 9,999,999,999,999 WHR 0 to 9,999,999,999,999 VARH	000.000 kWh to 999,999 MWh	000.000 kWh to 000,000 MWh; 000.000 kVAR to 000,000 MVARh
Real (In) Real (Out) Reactive (In) Reactive (Out) Apparent	0 to 9,999,999,999,999 WHR 0 to 9,999,999,999,999 WHR 0 to 9,999,999,999,999 VARH 0 to 9,999,999,999,999 VARH 0 to 9,999,999,999,999 VAH	Not Applicable	Not Applicable
Accumulated Energy, Conditional			
Real (In)	0 to 9,999,999,999,999 WHR		
Real (Out)	0 to 9,999,999,999,999 WHR		
Reactive (In)	0 to 9,999,999,999,999 VARH		
Reactive (Out)	0 to 9,999,999,999,999 VARH		
Apparent	0 to 9,999,999,999,999 VAH		
Accumulated Energy, Incremental			
Real (In)	0 to 999,999,999,999 WHR		
Real (Out)	0 to 999,999,999,999 WHR		
Reactive (In)	0 to 999,999,999,999 VARH		
Reactive (Out)	0 to 999,999,999,999 VARH		
Apparent	0 to 999,999,999,999 VAH		

① Via communications only.

② You can configure the resolution to display energy on the front panel or allow it to auto-range (default). See Appendix B, register 2027, page 97.

**GENERIC DEMAND  
(CONT.)**

The circuit monitor can accumulate these energy values in one of two modes: signed or unsigned (absolute). In signed mode, the circuit monitor considers the direction of power flow, allowing the accumulated energy magnitude to both increase and decrease. In unsigned mode, the circuit monitor accumulates energy as positive, regardless of the direction of power flow; in other words, the energy value increases, even during reverse power flow. The default accumulation mode is unsigned. Accumulated energy can be viewed from the front panel display. The resolution of the energy value will automatically change through the range of 000.000 kWh to 000,000 MWh (000.000 kVARh to 000,000 kVARh), or it can be fixed. (See Appendix B, register 2027 on page 97.)

The circuit monitor provides additional energy readings that are available over the communications link only. They are:

- **Directional accumulated energy readings.** The circuit monitor calculates and stores in nonvolatile memory accumulated values for energy (kWH) and reactive energy (kVARH) both into and out of the load. The circuit monitor also calculates and stores apparent energy (kVAH).
- **Conditional accumulated energy readings.** Using these values, energy accumulation can be turned off or on for special metering applications. Accumulation can be turned on over the communications link, or activated from a status input change. The circuit monitor stores the date and time of the last reset of conditional energy in nonvolatile memory.
- **Incremental accumulated energy readings.** The real, reactive and apparent incremental energy values reflect the energy accumulated during the last incremental energy period. You can define the increment start time and time interval. Incremental energy values can be logged in circuit monitor memory (models CM-2150 and up) and used for load-profile analysis.

**POWER ANALYSIS VALUES**

The circuit monitor provides a number of power analysis values that can be used to detect power quality problems, diagnose wiring problems, and more. Table 2-4 on page 16 summarizes the power analysis values.

**THD**—Total Harmonic Distortion (THD) is a quick measure of the total distortion present in a waveform. It provides a general indication of the “quality” of a waveform. The circuit monitor uses the following equation to calculate THD:

$$\text{THD} = \frac{\sqrt{H_2^2 + H_3^2 + H_4^2 + \dots}}{H_1} \times 100\%$$

**thd**—An alternate method for calculating Total Harmonic Distortion, used widely in Europe. The circuit monitor uses the following equation to calculate thd:

$$\text{thd} = \frac{\sqrt{H_2^2 + H_3^2 + H_4^2 + \dots}}{\text{Total rms}} \times 100\%$$

**K-Factor**—K-Factor is a simple numerical rating used to specify transformers for nonlinear loads. The circuit monitor uses the following formula to calculate K-Factor:

$$K = \frac{\text{SUM } (I_h)^2 h^2}{I_{\text{rms}}^2}$$

**POWER ANALYSIS VALUES  
(Cont.)**

**Displacement Power Factor**—For purely sinusoidal loads, the power factor calculation kW/kVA is equal to the cosine of the angle between the current and voltage waveforms. For harmonically distorted loads, the true power factor equals kW/kVA—but this may not equal the angle between the fundamental components of current and voltage. The displacement power factor is based on the angle between the fundamental components of current and voltage.

**Harmonic Values**—The individual per-phase harmonic magnitudes and angles through the 31st harmonic are determined for all currents and voltages in model numbers 2350 and higher circuit monitors. The harmonic magnitudes can be formatted as either a percentage of the fundamental (default), or a percentage of the rms value. Refer to **Chapter 9—Advanced Topics** for information on how to configure the harmonic calculations.

**Table 2-4  
Power Analysis Values**

Value	Reportable Range
THD-Voltage, Current 3-phase, per-phase, neutral	0 to 3,276.7%
thd-Voltage, Current 3-phase, per-phase, neutral	0 to 3,276.7%
K-Factor (per phase)	0.0 to 100.0
K-Factor Demand (per phase) ①	0.0 to 100.0
Crest Factor (per phase) ①	0.0 to 100.0
Displacement P.F. (per phase, 3-phase) ①	-0.010 to 1.000 to +0.010
Fundamental Voltages (per phase) ①	
Magnitude	0 to 3,276,700 V
Angle	0.0 to 359.9°
Fundamental Currents (per phase) ①	
Magnitude	0 to 32,767 A
Angle	0.0 to 359.9°
Fundamental Real Power (per phase, 3-phase) ①	0 to 327,670 kW
Fundamental Reactive Power (per phase) ①	0 to 327,670 kVAR
Harmonic Power (per phase, 3-phase) ①	0 to 327,670 kW
Phase Rotation ①	ABC or CBA
Unbalance (current and voltage) ①	0.0 to 100%
Individual Harmonic Magnitudes ①	0 to 327.67%
Individual Harmonic Angles ①	0.0° to 360.0°

① Via communications only.



## CHAPTER 3—INPUT/OUTPUT CAPABILITIES

### CHAPTER CONTENTS

Input/Output Modules .....	17
Status Inputs .....	18
Demand Synch Pulse Input .....	19
Analog Inputs .....	20
Analog Input Example .....	21
Relay Output Operating Modes .....	22
Mechanical Relay Outputs .....	24
Setpoint Controlled Relay Functions .....	25
Solid State KYZ Pulse Output .....	26
2-Wire Pulse Initiator .....	26
3-Wire Pulse Initiator .....	27
Calculating the Watthour-per-pulse Value .....	28
Analog Outputs .....	29
Analog Output Example .....	30

### INPUT/OUTPUT MODULES

The circuit monitor supports a variety of input/output options through the use of optional add-on I/O modules. The I/O modules attach to the back of the circuit monitor. Each I/O module provides some or all of the following:

- Status Inputs
- Mechanical Relay Outputs
- Solid State KYZ Pulse Output
- Analog Inputs
- Analog Outputs

Table 3-1 lists the available I/O Modules. The remainder of this chapter describes the I/O capabilities. For module installation instructions and detailed technical specifications, refer to the appropriate instruction bulletin (see list on page 6 of the *Circuit Monitor Installation and Operation Bulletin*).

**Table 3-1**  
**Input/Output Modules**

Class	Type	Description	Max. Control Power Burden When IOM Present	
			120 V	240V
3020	IOM-11	1 status IN, 1 KYZ pulse OUT	11 VA	15 VA
3020	IOM-18	8 status IN, 1 KYZ pulse OUT	11 VA	15 VA
3020	IOM-44	4 status IN, 1 KYZ pulse OUT, 3 Form-C relay OUT	14 VA	20 VA
3020	IOM-4411-01	4 status IN, 1 KYZ pulse OUT, 3 Form-C relay OUT, 1 Analog IN <sup>①</sup> , 1 Analog OUT (0–1 mA)	20 VA	25 VA
3020	IOM-4411-20	4 status IN, 1 KYZ pulse OUT, 3 Form-C relay OUT, 1 Analog IN <sup>①</sup> , 1 Analog OUT (4–20 mA)	20 VA	25 VA
3020	IOM-4444-01	4 status IN, 1 KYZ pulse OUT, 3 Form-C relay OUT, 4 Analog IN <sup>①</sup> , 4 Analog OUT (0–1 mA)	21 VA	27 VA
3020	IOM-4444-20	4 status IN, 1 KYZ pulse OUT, 3 Form-C relay OUT, 4 Analog IN <sup>①</sup> , 4 Analog OUT (4–20 mA)	21 VA	27 VA

<sup>①</sup> Analog Inputs are 0–5 Vdc. Each analog input can be independently configured to accept a 4-20 mA input by connecting an external jumper wire. See **Analog Inputs** in this chapter for more information.

## STATUS INPUTS

The circuit monitor's I/O modules offer 1, 4, or 8 status inputs (see table 3-1 on the previous page). Status inputs can be used to detect breaker status, count pulses, count motor starts, and so on.

The following are important points about the circuit monitor's status inputs:

- The circuit monitor maintains a counter of the total transitions for each status input.
- Status input S2 is a high-speed status input. Input S2 can be tied to an external relay used to trigger the circuit monitor's 12-cycle event capture feature (see **Extended Event Capture** in **Chapter 6**).

*Note: The IOM-11 module does not have an input S2.*

- Status input transitions can be logged as events in the circuit monitor's on-board event log.
- Status input transition events are date and time stamped. For the IOM-11, IOM-18, and IOM-44, the date and time are accurate to within one second. For the IOM-4411 and IOM-4444, all status input transition events are time stamped with resolution to the millisecond, for sequence of events recording.
- Status input S1 can be configured to accept a demand synch pulse from a utility demand meter (see **Demand Synch Pulse Input** on the next page).
- Status inputs can be configured to control conditional energy (see **Conditional Energy** in **Chapter 9** for more information).
- Status inputs can be used to count KYZ pulses for demand and energy calculation. By mapping multiple inputs to the same counter register, the circuit monitor can totalize pulses from multiple inputs (see **Status Input Pulse Demand Metering** in **Chapter 9** for more information).

## DEMAND SYNCH PULSE INPUT

The circuit monitor can be configured to accept—through status input S1—a demand synch pulse from another demand meter. By accepting the demand synch pulses, the circuit monitor can make its demand interval “window” match the other meter’s demand interval “window.” The circuit monitor does this by “watching” status input S1 for a pulse from the other demand meter. When it sees a pulse, it starts a new demand interval and calculates the demand for the preceding interval. The circuit monitor then uses the same time interval as the other meter for each demand calculation. Figure 3-1 illustrates this point.

When in this mode, the circuit monitor will not start or stop a demand interval without a pulse. The maximum allowable time between pulses is 60 minutes. If 61 minutes pass before a synch pulse is received, the circuit monitor throws out the demand calculations and begins a new calculation when the next pulse is received. Once in synch with the billing meter, the circuit monitor can be used to verify peak demand charges.

Important facts about the circuit monitor’s demand synch feature are listed below:

- The demand synch feature can be activated from the circuit monitor’s front panel. To activate the feature, enter a demand interval of zero. (See **Setting the Demand Interval** in **Chapter 4** of the *Circuit Monitor Installation and Operation Bulletin* for instructions.)
- When the circuit monitor’s demand interval is set to zero, the circuit monitor automatically looks to input S1 for the demand synch pulse. The synch pulse output on the other demand meter *must* be wired to circuit monitor input S1. (Refer to the appropriate I/O Module instruction bulletin for wiring instructions.)
- The maximum allowable interval between pulses is 60 minutes.

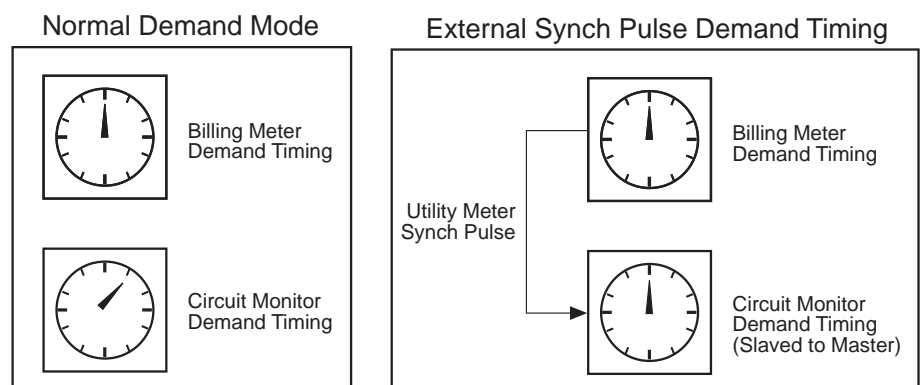

Figure 3-1: Demand synch pulse timing

## ANALOG INPUTS

The circuit monitor supports analog inputs through the use of optional input/output modules. I/O module IOM-4411 offers one analog input. I/O module IOM-4444 offers four analog inputs. Table 3-1, on page 17, lists the available input/output modules.

This section describes the circuit monitor's analog input capabilities. For technical specifications and instructions on installing the modules, refer to the appropriate instruction bulletin (see list on page 6 of the *Circuit Monitor Installation and Operation Bulletin*).

Each analog input can accept either a 0–5 Vdc voltage input, or a 4–20 mA dc current input. By default, the analog inputs accept a 0–5 Vdc input. To change an analog input to accept a 4–20 mA signal, the user must connect a jumper wire to the appropriate terminals on the input module. The jumper wire places a calibrated 250 ohm resistor (located inside the I/O module) into the circuit. When a 4–20 mA current is run through the resistor, the circuit monitor measures an input voltage of 1–5 volts across the resistor. Refer to the appropriate I/O module instruction bulletin for instructions on connecting the jumper wire.

To setup analog inputs, application software is required. Using POWERLOGIC application software, the user must define the following values for each analog input:

- **Units**—A six character label used to identify the units of the monitored analog value (for example, "PSI").
- **Input Type (0–5 V or 4–20 mA)**—Tells the circuit monitor whether to use the default calibration constants, or the alternate calibration constants for the internal 250 ohm resistor.
- **Upper Limit**—The value the circuit monitor reports when the input voltage is equal to 5 volts (the maximum input voltage).
- **Lower Limit**—The value the circuit monitor reports when the input voltage is equal to the *offset voltage*, defined below.
- **Offset Voltage**—The lowest input voltage (in hundredths of a volt) that represents a valid reading. When the input voltage is equal to this value, the circuit monitor reports the *lower limit*, defined above.
- **Precision**—The precision of the measured analog value (for example, *tenths* of degrees Celsius). This value represents what power of 10 to apply to the upper and lower limits.

The following are important facts regarding the circuit monitor's analog input capabilities:

- When the input voltage is below the offset voltage, the circuit monitor reports -32,768; POWERLOGIC application software indicates that the reading is invalid by displaying N/A or asterisks.
- When the input voltage is above five volts (the maximum input voltage) the circuit monitor reports the upper limit.

**Analog Input Example**

Figure 3-2 shows an analog input example. In this example, the analog input has been configured as follows:

Upper Limit: 500  
 Lower Limit: 100  
 Offset Voltage: 1 Volt  
 Units: PSI

The table below shows circuit monitor readings at various input voltages.

Input Voltage	Circuit Monitor Reading
.5 V	-32,768 (invalid)
1 V	100 PSI
2 V	200 PSI
2.5 V	250 PSI
5 V	500 PSI
5.5 V	500 PSI

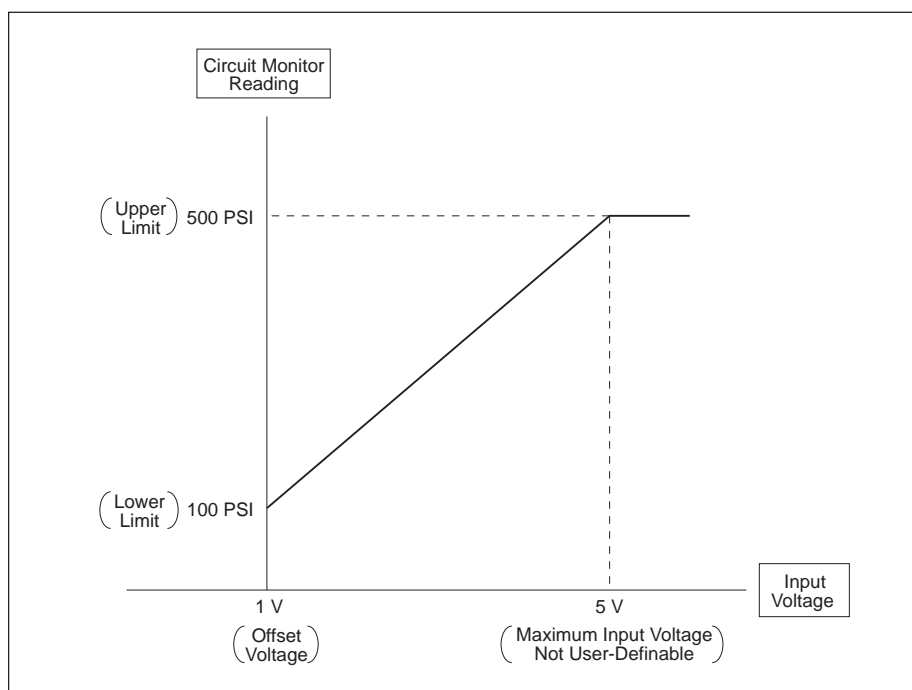

Figure 3-2: Analog input example

## RELAY OUTPUT OPERATING MODES

Before we describe the 10 available relay operating modes, it is important to understand the difference between a relay configured for *remote (external) control* and a relay configured for *circuit monitor (internal) control*.

Each mechanical relay output must be configured for one of the following

1. Remote (external) control—the relay is controlled either from a PC using POWERLOGIC application software, a programmable controller or, in the case of a CM-2450 or CM-2452, a custom program executing in the meter.
2. Circuit monitor (internal) control—the relay is controlled by the circuit monitor (models CM-2150 and above), in response to a set-point controlled alarm condition, or as a pulse initiator output

Once you've set up a relay for circuit monitor control (option 2 above), you can no longer operate the relay remotely. You can, though, temporarily override the relay, using POWERLOGIC application software.

The first three operating modes—normal, latched, and timed—function differently when the relay is *remotely* controlled versus *circuit monitor* controlled. The descriptions below point out the differences in remote versus circuit monitor control. Modes 4 through 10—all pulse initiation modes—are circuit monitor control modes; remote control does not apply to these modes.

### 1. Normal

*Remotely Controlled:* The user must energize the relay by issuing a command from a remote PC or programmable controller. The relay remains energized until a command to de-energize is issued from a remote PC or programmable controller, or until the circuit monitor loses control power.

*Circuit Monitor Controlled:* When an alarm condition assigned to the relay occurs, the relay is energized. The relay is not de-energized until *all* alarm conditions assigned to the relay have dropped out, or until the circuit monitor loses control power.

### 2. Latched

*Remotely Controlled:* The user must energize the relay by issuing a command from a remote PC or programmable controller. The relay remains energized until a command to de-energize is issued from a remote PC or programmable controller, or until the circuit monitor loses control power.

*Circuit Monitor Controlled:* When an alarm condition assigned to the relay occurs, the relay is energized. The relay remains energized—even after all alarm conditions assigned to the relay have dropped out—until a command to de-energize is issued from a remote PC or programmable controller, until the P1 alarm log is cleared from the front panel, or until the circuit monitor loses control power.

### 3. Timed

*Remotely Controlled:* The user must energize the relay by issuing a command from a remote PC or programmable controller. The relay remains energized until the timer expires, or until the circuit monitor loses control power. If a new command to energize the relay is issued before the timer expires, the timer restarts.

*Circuit Monitor Controlled:* When an alarm condition assigned to the relay occurs, the relay is energized. The relay remains energized for the duration of the timer. When the timer expires, if the alarm has dropped out, the relay will de-energize and remain de-energized. However, if the alarm is still active when the relay timer expires, the relay will de-energize and rapidly re-energize; this sequence will repeat until the alarm condition drops out.

### 4. Absolute kWH Pulse

This mode assigns the relay to operate as a pulse initiator with a user-defined number of kWH per pulse. In this mode, both forward and reverse real energy are treated as additive (as in a tie breaker).

### 5. Absolute kVARH Pulse

This mode assigns the relay to operate as a pulse initiator with a user-defined number of kVARH per pulse. In this mode, both forward and reverse reactive energy are treated as additive (as in a tie breaker).

### 6. kVAH Pulse

This mode assigns the relay to operate as a pulse initiator with a user-defined number of kVAH per pulse. Since kVA has no sign, there is only one mode for kVAH pulse.

### 7. kWH In Pulse

This mode assigns the relay to operate as a pulse initiator with a user-defined number of kWH per pulse. In this mode, only the kWH flowing *into* the load is considered.

### 8. kVARH In Pulse

This mode assigns the relay to operate as a pulse initiator with a user-defined number of kVARH per pulse. In this mode, only the kVARH flowing *into* the load is considered.

### 9. kWH Out Pulse

This mode assigns the relay to operate as a pulse initiator with a user-defined number of kWH per pulse. In this mode, only the kWH flowing *out of* the load is considered.

### 10. kVAR Out Pulse

This mode assigns the relay to operate as a pulse initiator with a user-defined number of kVARH per pulse. In this mode, only the kVARH flowing *out of* the load is considered.

## **MECHANICAL RELAY OUTPUTS**

Input/Output module IOM-44 provides three Form-C 10 A mechanical relays that can be used to open or close circuit breakers, annunciate alarms, and more. Table 3-1 on page 17 lists the available Input/Output modules (optional).

Circuit monitor mechanical output relays can be configured to operate in one of 10 operating modes:

- Normal
- Latched (electrically held)
- Timed
- Absolute kWh pulse
- Absolute kVARH pulse
- kVAH pulse
- kWh in pulse
- kVARH in pulse
- kWh out pulse
- kVAr out pulse

See the previous section for a description of the modes.

The last seven modes in the above list are for pulse initiator applications. Keep in mind that all circuit monitor Input/Output modules provide one solid-state KYZ pulse output rated at 96 mA. The solid-state KYZ output provides the long life—billions of operations—required for pulse initiator applications. The mechanical relay outputs have limited lives: 10 million operations under no load; 100,000 under load. For maximum life, use the solid-state KYZ pulse output for pulse initiation, except when a rating higher than 96 mA is required. See **Solid State KYZ Pulse Output** in this chapter for a description of the solid-state KYZ pulse output.



### **Setpoint Controlled Relay Functions**

The circuit monitor can detect over 100 alarm conditions, including over under conditions, status input changes, phase unbalance conditions, and more (see **Chapter 4—Alarm Functions**). Using POWERLOGIC application software, an alarm condition can be assigned to automatically operate one or more relays. For example, you could setup the alarm condition “Undervoltage Phase A” to operate relays R1, R2, and R3. Then, each time the alarm condition occurs—that is, each time the setpoints and time delays assigned to Undervoltage Phase A are satisfied—the circuit monitor automatically operates relays R1, R2, and R3 per their configured mode of operation. (See **Relay Output Operating Modes** in this chapter for a description of the operating modes.)

Also, multiple alarm conditions can be assigned to a single relay. For example, the alarm conditions “Undervoltage Phase A” and “Undervoltage Phase B” could both be assigned to operate relay R1. The relay remains energized as long as either “Undervoltage Phase A” or “Undervoltage Phase B” remains true.

*Note: Setpoint-controlled relay operation can be used for some types of non-time-critical relaying. For more information, see **Setpoint Controlled Relay Functions** in **Chapter 4**.*

## **SOLID-STATE KYZ PULSE OUTPUT**

This section describes the circuit monitor's pulse output capabilities. For instructions on wiring the KYZ pulse output, refer to the appropriate instruction bulletin.

Input/Output modules IOM-11, IOM-18, IOM-44, IOM-4411, and IOM-4444 are all equipped with one solid-state KYZ pulse output contact (see table 3-1 on page 17). This solid-state relay provides the extremely long life—billions of operations—required for pulse initiator applications.

The KYZ output is a Form-C contact with a maximum rating of 96 mA. Since most pulse initiator applications feed solid state receivers with very low burdens, this 96 mA rating is generally adequate. For applications where a rating higher than 96 mA is required, the IOM-44 provides 3 relays with 10 amp ratings. Any of the 10 amp relays can be configured as a pulse initiator output, using POWERLOGIC application software. Keep in mind that the 10 amp relays are mechanical relays with limited life—10 million operations under no load; 100,000 under load.

The watthour-per-pulse value can be set from the circuit monitor's front panel. When setting the kWh/pulse value, set the value based on a 3-wire pulse output basis. See **Setting the Watthour Pulse Output in Chapter 4** of the *Circuit Monitor Installation and Operation Bulletin* for instructions. See **Calculating the Watthour Per Pulse Value** in this chapter for instructions on calculating the correct value.

The circuit monitor can be used in 2-wire or 3-wire pulse initiator applications. Each of these applications is described below.

### **2-Wire Pulse Initiator**

Most energy management system digital inputs use only two of the three wires provided with a KYZ pulse initiator. This is referred to as a 2-wire pulse initiator application. Figure 3-3 shows a pulse train from a 2-wire pulse initiator application. Refer to this figure when reading the following points:

- In a 2-wire application, the pulse train looks like alternating open and closed states of a Form-A contact.
- Most 2-wire KYZ pulse applications use a Form-C contact, but tie into only one side of the Form-C contact.
- The pulse is defined as the transition from OFF to ON of one side of the Form-C relay.
- In figure 3-3, the transitions are marked as 1 and 2. Each transition represents the time when the relay flip-flops from KZ to KY. At points 1 and 2, the receiver should count a pulse.
- In a 2-wire application, the circuit monitor can deliver up to 5 pulses per second.

### 3-Wire Pulse Initiator

Some pulse initiator applications require all three wires provided with a KYZ pulse initiator. This is referred to as a 3-wire pulse initiator application. Figure 3-4 shows a pulse train for a 3-wire pulse initiator application. Refer to this figure when reading the following points:

- 3-wire KYZ pulses are defined as transitions between KY and KZ.
- These transitions are alternate contact closures or “flip-flops” of a Form-C contact.
- In figure 3-4 the transitions are marked as 1, 2, 3, and 4. Each transition represents the time when the relay flip flops from KY to KZ, or from KZ to KY. At points 1, 2, 3, and 4, the receiver should count a pulse.
- In a 3-wire application, the circuit monitor can deliver up to 10 pulses per second.

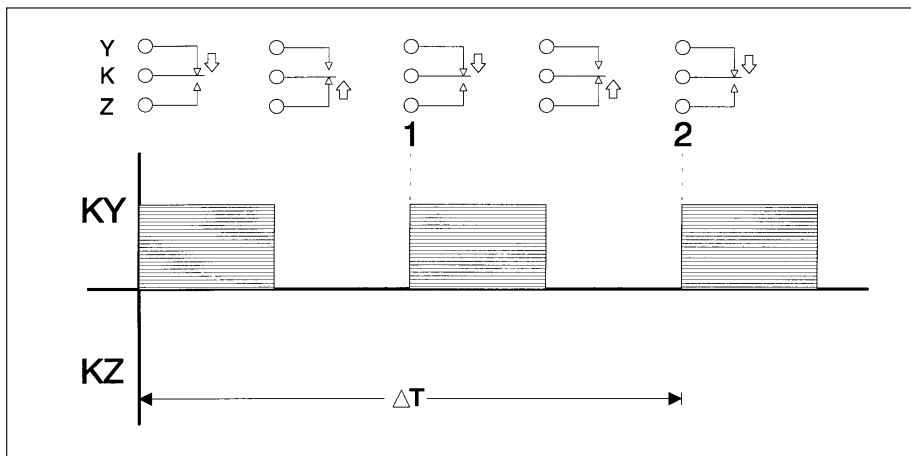

Figure 3-3: 2-wire pulse train

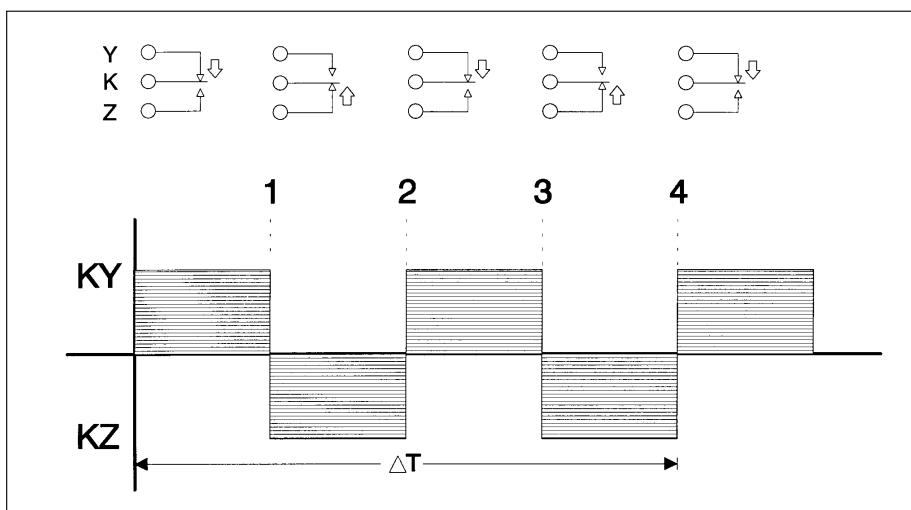

Figure 3-4: 3-wire pulse train

### Calculating the Watthour-Per-Pulse Value

This section shows an example of how to calculate the watthour-per-pulse value. To calculate this value, first determine the highest kW value you can expect and the required pulse rate. In this example, the following assumptions are made:

- The metered load should not exceed 1500 kW.
- The KYZ pulses should come in at about two pulses per second at full scale.

**Step 1:** Translate 1500 kW load into kWh/second.

$$(1500 \text{ kW}) (1 \text{ Hr}) = 1500 \text{ kWh}$$

$$\frac{(1500 \text{ kWh})}{1 \text{ hour}} = \frac{\text{"X" kWh}}{1 \text{ second}}$$

$$\frac{(1500 \text{ kWh})}{3600 \text{ seconds}} = \frac{\text{"X" kWh}}{1 \text{ second}}$$

$$X = 1500/3600 = 0.4167 \text{ kWh/second}$$

**Step 2:** Calculate the kWh required per pulse.

$$\frac{0.4167 \text{ kWh/second}}{2 \text{ pulses/second}} = 0.2084 \text{ kWh/pulse}$$

**Step 3:** Round to nearest tenth, since the circuit monitor only accepts 0.1 kWh increments.

$$K_e = 0.2 \text{ kWh/pulse}$$

#### Summary:

- 3-wire basis—0.2 kWh/pulse will provide approximately 2 pulses per second at full scale.
- 2-wire basis—0.1 kWh/pulse will provide approximately 2 pulses per second at full scale. (To convert to the kWh/pulse required on a 2-wire basis, divide  $K_e$  by 2. This is necessary since the circuit monitor Form C relay generates two pulses—KY and KZ—for every pulse that is counted on a 2-wire basis.)

## ANALOG OUTPUTS

The circuit monitor supports analog outputs through the use of optional input/output modules. I/O modules IOM-4411-20 and IOM-4444-20 offer one and four 0-20 mA analog outputs, respectively. I/O modules IOM-4411-01 and IOM-4444-01 offer one and four 0-1 mA analog outputs, respectively. Table 3-1, on page 17, lists the available input/output modules.

This section describes the circuit monitor's analog output capabilities. For technical specifications and instructions on installing the modules, refer to page 6 of the *Circuit Monitor Installation and Operation Bulletin*.

To setup analog outputs, application software is required. Using POWERLOGIC application software, the user must define the following values for each analog output:

- **Analog Output Label**—A four character label used to identify the output.
- **Output Range**—The range of the output current: 4–20 mA, for the IOM-4411-20 and IOM-4444-20; 0–1 mA, for the IOM-4411-01 and IOM-4444-01.
- **Register Number**—The circuit monitor register number assigned to the analog output.
- **Lower Limit**—The register value that is equivalent to the minimum output current (0 or 4 mA).
- **Upper Limit**—The register value that is equivalent to the maximum output current (1 mA or 20 mA).

The following are important facts regarding the circuit monitor's analog output capabilities:

- When the register value is below the *lower limit*, the circuit monitor outputs the minimum output current (0 or 4 mA).
- When the register value is above the *upper limit*, the circuit monitor outputs the maximum output current (1 mA or 20 mA).



### CAUTION

#### HAZARD OF EQUIPMENT DAMAGE.

Each analog output represents an individual 2-wire current loop. Therefore, an isolated receiver *must* be used for each individual analog output from an IOM-4411 and IOM-4444.

**Failure to observe this precaution can result in equipment damage.**

**Analog Output Example**

Figure 3-5 illustrates the relationship between the output range and the upper and lower limit. In this example, the analog output has been configured as follows:

- Output Range: 4-20 mA
- Register Number: 1042 (Real Power, 3-Phase Total)
- Lower Limit: 100 kW
- Upper Limit: 500 kW

The list below shows the output current at various register readings.

Register Reading	Output Current
50 kW	4 mA
100 kW	4 mA
200 kW	8 mA
250 kW	10 mA
500 kW	20 mA
550 kW	20 mA

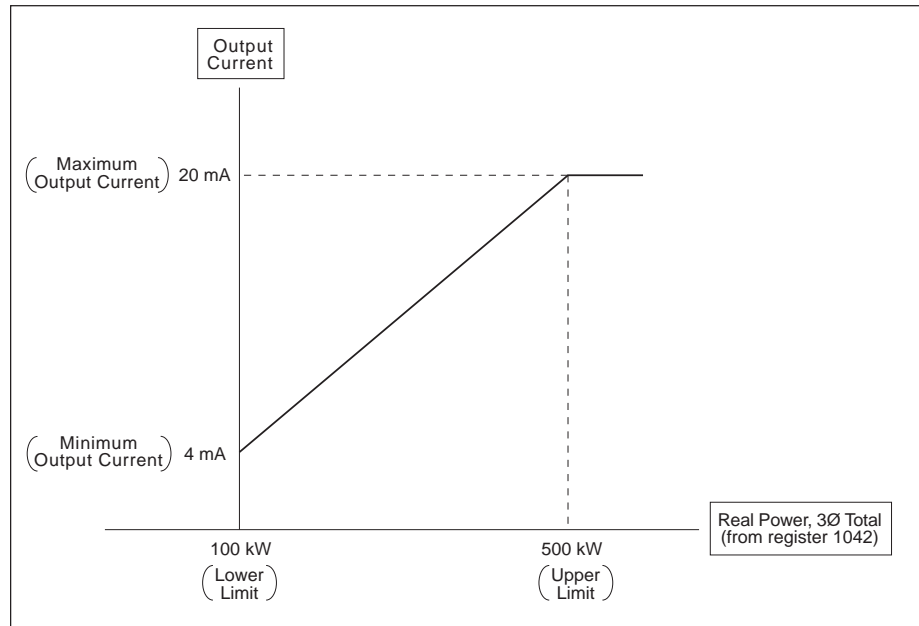

Figure 3-5: Analog output example

## CHAPTER 4—ALARM FUNCTIONS

The circuit monitor (models CM-2150 and higher) can detect over 100 alarm conditions, including over/under conditions, status input changes, phase unbalance conditions, and more. (See **Alarm Conditions and Alarm Codes** in **Appendix D** for a complete list of alarm conditions.) The circuit monitor maintains a counter for each alarm to keep track of the total number of occurrences.

These alarm conditions are tools that enable the circuit monitor to execute tasks automatically. Using POWERLOGIC application software, each alarm condition can be assigned one or more of the following tasks.

- Force data log entries in up to 14 user-defined data log files (see **Data Logging** in **Chapter 5**)
- Operate one or more mechanical relays (see **Mechanical Relay Outputs** in **Chapter 3**)
- Perform a 4-cycle waveform capture (see **4-Cycle Waveform Capture** in **Chapter 6**)
- Perform a 12-cycle waveform capture (see **Extended Event Capture** in **Chapter 6**)

**SETPOINT-DRIVEN ALARMS** Many of the alarm conditions—including all over, under, and phase unbalance alarm conditions—require that you define setpoints. Other alarm conditions, such as status input transitions and phase reversals do not require setpoints. For those alarm conditions that require setpoints, you must define the following information:

- Pickup Setpoint
- Pickup Delay (in seconds)
- Dropout Setpoint
- Dropout Delay (in seconds)

For instructions on setting up alarm/relay functions from the circuit monitor front panel, see **Setting Up Alarm/Relay Functions** in **Chapter 4** of the *Circuit Monitor Installation and Operation Bulletin*.

To understand how the circuit monitor handles setpoint-driven alarms, see figure 4-2. Figure 4-1 shows what the actual event log entries for figure 4-2 might look like, as displayed by POWERLOGIC application software.

*Note:* The software does not actually display the codes in parentheses—EV1, EV2, Max1, Max2. These are references to the codes in figure 4-2.

On-Board Event Log:cm2350					
	Date/Time	Event	Value	Condition	Forced Log Entry
EV1 →	21 08/23/95 06:49:22.000 AM	Over Current B	61	Pickup	1,WFC-4
	22 08/23/95 06:49:22.000 AM	Over Current C	48	Pickup	1,WFC-4
EV2 →	23 08/23/95 06:49:26.000 AM	Over Current C	48	Dropout	
	24 08/23/95 06:49:37.000 AM	Over Current B	61	Dropout	

Figure 4-1: Sample event log entry

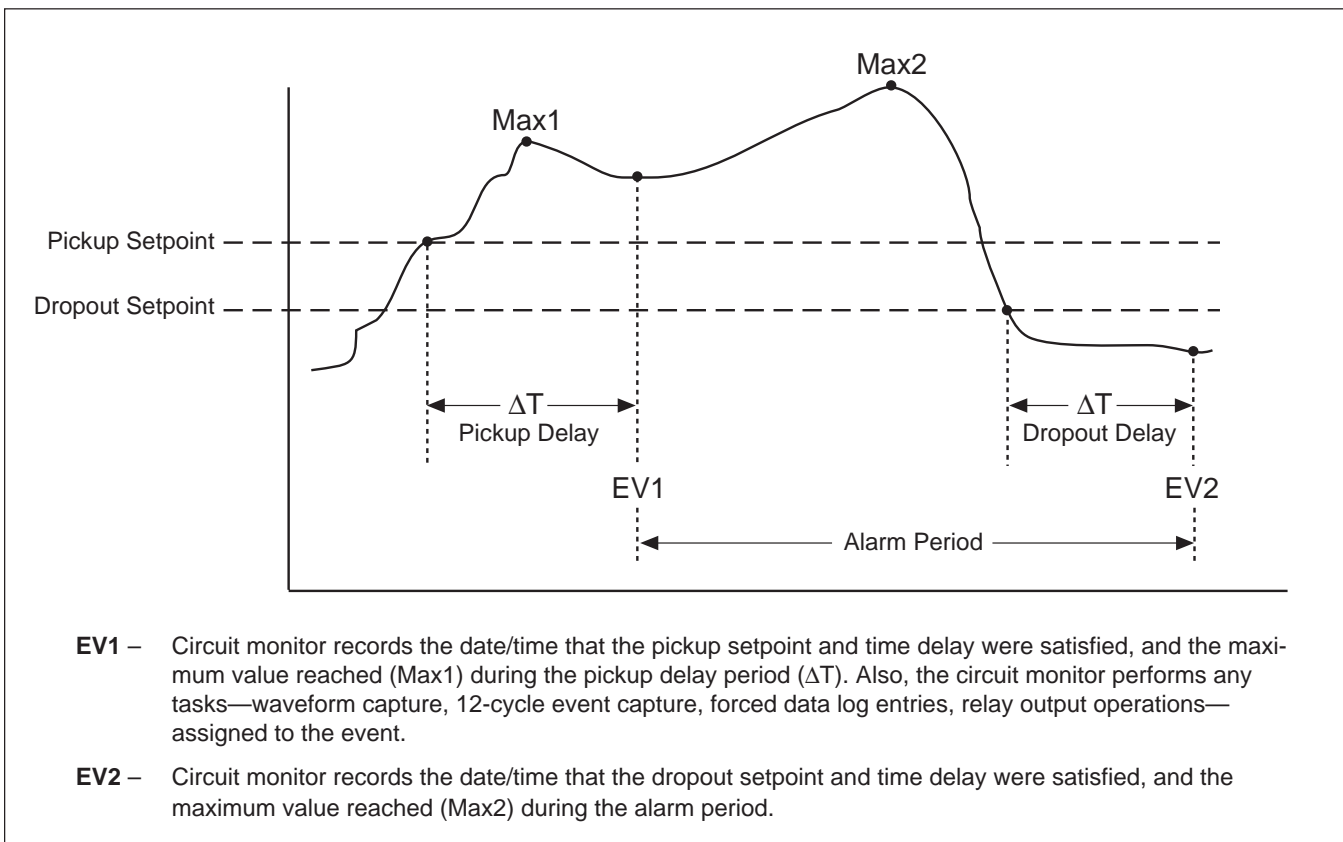

Figure 4-2: How the circuit monitor handles setpoint-driven alarms



## SETPOINT-CONTROLLED RELAY FUNCTIONS

A circuit monitor—model CM-2150 (or higher) equipped with an I/O module—can mimic the functions of certain motor management devices such as phase loss, undervoltage, or reverse phase relays. While the circuit monitor is not a primary protective device, it can detect abnormal conditions and respond by operating one or more Form-C output contacts. These outputs can be used to operate an alarm horn or bell to annunciate the alarm condition.

*Note: The circuit monitor is not designed for use as a primary protective relay. While its setpoint-controlled functions may be acceptable for certain applications, it should not be considered a substitute for proper circuit protection.*

If the user determines that the circuit monitor's performance is acceptable, the output contacts can be used to mimic some functions of a motor management device. When deciding if the circuit monitor is acceptable for these applications, keep the following points in mind:

- Circuit monitors require control power in order to operate properly.
- Circuit monitors may take up to 5 seconds after control power is applied before setpoint-controlled functions are activated. If this is too long, a reliable source of control power is required.
- When control power is interrupted for more than approximately 100 milliseconds, the circuit monitor releases all energized output contacts.
- Standard setpoint-controlled functions may take 2–3 seconds to operate, even if no delay is intended.
- A password is required to program the circuit monitor's setpoint controlled relay functions.

A description of some common motor management functions follows. For detailed instructions on setting up setpoint-controlled functions from the circuit monitor's front panel, see **Setting Up Alarm/Relay Functions in Chapter 4** of the *Circuit Monitor Installation and Operation Bulletin*, and **Appendix D—Alarm Setup Information** in this bulletin.

### Undervoltage:

- Pickup and dropout setpoints are entered in volts. Very large values may require scale factors. Refer to **Setting Scale Factors for Extended Metering Ranges in Chapter 9** for more information on scale factors.
- The per-phase undervoltage alarm occurs when the per-phase voltage is equal to or below the pickup setpoint long enough to satisfy the specified pickup delay (in seconds).
- When the undervoltage alarm occurs, the circuit monitor operates any specified relays.
- Relays configured for normal mode operation remain closed until the under voltage alarm clears. The undervoltage alarm clears when the phase voltage remains above the dropout setpoint for the specified dropout delay period.

### **Setpoint-Controlled Relay Functions (cont.)**

- To release any relays that are in latched mode, enter the circuit monitor's Alarm mode and select the clear option. For detailed instructions, see **Clearing the Priority 1 Log** in **Chapter 4** of the *Circuit Monitor Installation and Operation Bulletin*.

#### **Overvoltage:**

- Pickup and dropout setpoints are entered in volts. Very large values may require scale factors. Refer to **Setting Scale Factors for Extended Metering Ranges** in **Chapter 9** for more information on scale factors.
- The per-phase overvoltage alarm occurs when the per-phase voltage is equal to or above the pickup setpoint long enough to satisfy the specified pickup delay (in seconds).
- When the overvoltage alarm occurs, the circuit monitor operates any specified relays.
- Relays configured for normal mode operation remain closed until the overvoltage alarm clears. The overvoltage alarm clears when the phase voltage remains below the dropout setpoint for the specified dropout delay period.
- To release any relays that are in latched mode, enter the circuit monitor's Alarm mode and select the *Clear* option. For detailed instructions, see **Clearing the Priority 1 Log** in **Chapter 4** of the *Circuit Monitor Installation and Operation Bulletin*.

#### **Unbalance Current:**

- Pickup and dropout setpoints are entered in tenths of percent, based on the percentage difference between each phase current with respect to the average of all phase currents. For example, enter an unbalance of 16.0% as 160.
- The unbalance current alarm occurs when the phase current deviates from the average of the phase currents, by the percentage pickup setpoint, for the specified pickup delay (in seconds).
- When the unbalance current alarm occurs, the circuit monitor operates any specified relays.
- Relays configured for normal mode operation remain closed until the unbalance current alarm clears. The unbalance current alarm clears when the percentage difference between the phase current and the average of all phases remains below the dropout setpoint for the specified dropout delay period.
- To release any relays that are in latched mode, enter the circuit monitor's Alarm mode and select the *Clear* option. For detailed instructions, see **Clearing the Priority 1 Log** in **Chapter 4** of the *Circuit Monitor Installation and Operation Bulletin*.

#### **Unbalance Voltage:**

- Pickup and dropout setpoints are entered in tenths of percent, based on the percentage difference between each phase voltage with respect to the average of all phase voltages. For example, enter an unbalance of 16.0% as 160.

### Setpoint-Controlled Relay Functions (cont.)

- The unbalance voltage alarm occurs when the phase voltage deviates from the average of the phase voltages, by the percentage pickup setpoint, for the specified pickup delay (in seconds).
- When the unbalance voltage alarm occurs, the circuit monitor operates any specified relays.
- Relays configured for normal mode operation remain closed until the unbalance voltage alarm clears. The unbalance voltage alarm clears when the percentage difference between the phase voltage and the average of all phases remains below the dropout setpoint for the specified dropout delay (in seconds).
- To release any relays that are in latched mode, enter the circuit monitor's Alarm mode and select the *Clear* option. For detailed instructions, see **Clearing the Priority 1 Log** in **Chapter 4** of the *Circuit Monitor Installation and Operation Bulletin*.

#### Phase Loss—Current:

- Pickup and dropout setpoints are entered in tenths of percent, based on a percentage ratio of the smallest current to the largest current. For example, enter 50% as 500.
- The phase loss current alarm occurs when the percentage ratio of the smallest current to the largest current is equal to or below the pickup setpoint for the specified pickup delay (in seconds).
- When the phase loss current alarm occurs, the circuit monitor operates any specified relays.
- Relays configured for normal mode operation remain closed until the phase loss current alarm clears. The phase loss current alarm clears when the ratio of the smallest current to the largest current remains above the dropout setpoint for the specified dropout delay (in seconds).
- To release any relays that are in latched mode, enter the circuit monitor's Alarm mode and select the *Clear* option. For detailed instructions, see **Clearing the Priority 1 Log** in **Chapter 4** of the *Circuit Monitor Installation and Operation Bulletin*.

#### Phase Loss—Voltage:

- Pickup and dropout setpoints are entered in volts.
- The phase loss voltage alarm occurs when any voltage value (but not all voltage values) is equal to or below the pickup setpoint for the specified pickup delay (in seconds).
- When the phase loss voltage alarm occurs, the circuit monitor operates any specified relays.
- Relays configured for normal mode operation remain closed until the phase loss voltage alarm clears. The alarm clears when one of the following is true:
  - *all* of the phases remain above the dropout setpoint for the specified dropout delay (in seconds), OR
  - *all* of the phases drop below the phase loss pickup setpoint.

### **Setpoint-Controlled Relay Functions (cont.)**

- If *all* of the phase voltages are equal to or below the pickup setpoint, during the pickup delay, the phase loss alarm will not activate. This is considered an under voltage condition. It should be handled by configuring the under voltage protective functions.
- To release any relays that are in latched mode, enter the circuit monitor's Alarm mode and select the *Clear* option. For detailed instructions, see **Clearing the Priority 1 Log** in **Chapter 4** of the *Circuit Monitor Installation and Operation Bulletin*.

#### **Reverse Power:**

- Pickup and dropout setpoints are entered in kilowatts. Very large values may require scale factors. Refer to **Setting Scale Factors for Extended Metering Ranges** in **Chapter 9** for more information on scale factors.
- The reverse power alarm occurs when the 3-phase power flow in the negative direction remains at or below the negative pickup value for the specified pickup delay (in seconds).
- When the reverse power alarm occurs, the circuit monitor operates any specified relays.
- Relays configured for normal mode operation remain closed until the reverse power alarm clears. The alarm clears when the 3-phase power reading remains above the dropout setpoint for the specified dropout delay (in seconds).
- To release any relays that are in latched mode, enter the circuit monitor's Alarm mode and select the *Clear* option. For detailed instructions, see **Clearing the Priority 1 Log** in **Chapter 4** of the *Circuit Monitor Installation and Operation Bulletin*.

#### **Phase Reversal:**

- Pickup and dropout setpoints and delays do not apply to phase reversal.
- The phase reversal alarm occurs when the phase voltage waveform rotation differs from the default phase rotation. The circuit monitor assumes that an ABC phase rotation is normal. If a CBA phase rotation is normal, the user must change the circuit monitor's phase rotation from ABC (default) to CBA. See **Chapter 9—Advanced Topics**.
- When the phase reversal alarm occurs, the circuit monitor operates any specified relays.
- Relays configured for normal mode operation remain closed until the phase reversal alarm clears.
- To release any relays that are in latched mode, enter the circuit monitor's Alarm mode and select the *Clear* option. For detailed instructions, see **Clearing the Priority 1 Log** in **Chapter 4** of the *Circuit Monitor Installation and Operation Bulletin*.

## CHAPTER 5—LOGGING

### CHAPTER CONTENTS

Event Logging .....	37
Event Log Storage .....	37
Data Logging .....	38
Alarm-Driven Data Log Entries .....	38
Organizing Data Log Files .....	38
Storage Considerations .....	39
Maintenance Log .....	40

### EVENT LOGGING

The circuit monitor provides an event log file to record the occurrence of important events. The circuit monitor can be configured to log the occurrence of any alarm condition as an event. The event log can be configured as *first-in-first-out* (FIFO) or *fill and hold*. Using POWERLOGIC application software, the event log can be uploaded for viewing and saved to disk, and the circuit monitor's event log memory can be cleared.

#### Event Log Storage

Circuit monitor models 2150 and higher provide nonvolatile memory for event log storage. The size of the event log (the maximum number of events) is user-definable. When determining the maximum number of events, take the circuit monitor's total storage capacity into consideration. For circuit monitor models 2150 and 2250, the total storage capacity must be allocated between the event log and up to 14 data logs. For circuit monitor models 2350, 2450, and 2452, the total data storage capacity must be allocated between an event log, a 4-cycle waveform capture log, an extended event capture log, and up to 14 data logs. See **Memory Allocation** in **Chapter 9** for additional memory considerations.

## DATA LOGGING

Circuit monitor models CM-2150 and higher are equipped with nonvolatile memory for storing meter readings at regular intervals. The user can configure up to 14 independent data log files. The following items can be configured for each data log file:

- Logging Interval—1 minute to 24 hours
- Offset Time
- First-In-First-Out (FIFO) or Fill & Hold
- Values to be logged—up to 100, including date/time of each log entry

Each data log file can be cleared, independently of the others, using POWERLOGIC application software. For instructions on setting up and clearing data log files, refer to the POWERLOGIC application software instruction bulletin.

### Alarm-Driven Data Log Entries

The circuit monitor can detect over 100 alarm conditions, including over under conditions, status input changes, phase unbalance conditions, and more. (See **Chapter 4—Alarm Functions** for more information.) Each alarm condition can be assigned one or more tasks, including forced data log entries into any or all data log files.

For example, assume that you've defined 14 data log files. Using POWERLOGIC software, you could select an alarm condition such as "Overcurrent Phase A" and set up the circuit monitor to force data log entries into any of the 14 log files each time the alarm condition occurs.

### Organizing Data Log Files

There are many ways to organize data log files. One possible way is to organize log files according to the logging interval. You might also define a log file for entries forced by alarm conditions. For example, you could set up four data log files as follows:

- Data Log 1:** Voltage *logged every minute*. File is large enough to hold 60 entries so that you could look back over the last hour's voltage readings.
- Data Log 2:** Voltage, current, and power *logged hourly* for a historical record over a longer period.
- Data Log 3:** Energy *logged once daily*. File is large enough to hold 31 entries so that you could look back over the last month and see daily energy use.
- Data Log 4:** Report by exception file. File contains data log entries that are forced by the occurrence of an alarm condition. See **Alarm-Driven Data Log Entries** above.

*Note: The same data log file can support both scheduled and alarm driven entries.*

Data log file 1 is pre-configured at the factory with a sample data log which records several parameters hourly. This sample data log can be reconfigured to meet your specific needs.

**Storage Considerations**

The following are important storage considerations:

- Circuit monitor model CM-2150 or higher is required for on-board data logging.
- For circuit monitor models CM-2150 and CM-2250, the total storage capacity must be allocated between the event log and up to 14 data logs. For circuit monitor model 2350 and higher, the total data storage capacity must be allocated between an event log, a 4-cycle waveform capture log, an extended event capture log, and up to 14 data logs.
- Circuit monitor standard models CM-2150, CM-2250, CM-2350, and CM-2450 store up to 51,200 values. Model CM-2452 stores up to 182,272 values. With the -512k memory option, models CM-2150, -2250, -2350, and -2450 store up to 313,344 values; with the -1024k memory option, models CM-2150, -2250, -2350, and -2450 store up to 575,488 values. (These numbers assume that you've devoted all of the circuit monitor's logging memory to data logging, and the series number of the circuit monitor is G4 or later.)
- Each defined data log file stores a date and time and requires some additional overhead. To minimize storage space occupied by dates/times and file overhead, use a few log files that log many values, as opposed to many log files that store only a few values each.
- See **Memory Allocation in Chapter 9** for additional storage considerations.

## MAINTENANCE LOG

The circuit monitor stores a maintenance log in nonvolatile memory. This log contains several values that are useful for maintenance purposes.

Table 5-1 below lists the values stored in the maintenance log and a short description of each. The values stored in the maintenance log are cumulative over the life of the circuit monitor and cannot be reset.

You can view the maintenance log using POWERLOGIC application software. For specific instructions, refer to the POWERLOGIC software instruction bulletin.

**Table 5-1**  
**Values Stored in Maintenance Log**

Value Stored	Description
Number of Demand Resets	Number of times demand values have been reset.
Number of Energy Resets	Number of times energy values have been reset.
Number of Min/Max Resets	Number of times min/max values have been reset.
Number of Output Operations	Number of times relay output has operated. This value is stored for each relay output.
Number of Power Losses	Number of times circuit monitor has lost control power.
Number of Firmware Downloads	Number of times new firmware has been downloaded to the circuit monitor over communications.
Number of Optical Comms Sessions	Number of times the front panel optical communications port has been used.
Highest Temperature Monitored	Highest temperature reached inside the circuit monitor.
Lowest Temperature Monitored	Lowest temperature reached inside the circuit monitor.



## CHAPTER 6—WAVEFORM CAPTURE

### CHAPTER CONTENTS

4-Cycle Waveform Capture .....	41
Manual Waveform Capture .....	41
Automatic Waveform Capture .....	41
Waveform Storage .....	43
Extended Event Capture .....	44
Manual Event Capture .....	44
Automatic Event Capture—High-Speed Trigger .....	44
Automatic Event Capture—Initiated by a Standard Setpoint .....	46
Extended Event Capture Storage .....	47

### 4-CYCLE WAVEFORM CAPTURE

Circuit monitor models CM-2250 and CM-2350 are equipped with waveform capture. Circuit monitors use a sophisticated, high-speed sampling technique to sample 64 times per cycle, simultaneously, on all current and voltage inputs.

There are two ways to initiate a waveform capture:

- Manually, from a remote personal computer, using POWERLOGIC application software
- Automatically, by the circuit monitor, when an alarm condition such as “Alarm #55: Over value THD voltage Phase A-B” occurs

Both methods are described below.

#### Manual Waveform Capture

Using POWERLOGIC application software, you can initiate a manual waveform capture from a remote personal computer. To initiate a manual waveform capture, select a circuit monitor equipped with waveform capture and issue the acquire command. The circuit monitor captures the waveform, and the software retrieves and displays it.

POWERLOGIC software lets you view all phase voltage and current waveforms simultaneously, or zoom in on a single waveform that includes a data block with extensive harmonic data.

For instructions on performing manual waveform capture using POWERLOGIC software, refer to the application software instruction bulletin.

#### Automatic Waveform Capture

The circuit monitor can detect over 100 alarm conditions—such as metering setpoint exceeded and status input changes (see **Chapter 4—Alarm Functions** for more information). The circuit monitor can be set up to automatically capture and save four cycles of waveform data associated with an alarm condition.

## Setting Up the Circuit Monitor

The circuit monitor must be set up for automatic waveform capture using POWERLOGIC application software. To set up the circuit monitor for automatic waveform capture, perform the following steps:

1. Select an alarm condition. (See **Appendix D** for a listing of alarm conditions.)
2. Define the setpoints. (This may not be necessary if the selected alarm is a status input change, for example.)
3. Select the automatic waveform capture option.

Repeat these steps for the desired alarm conditions. For specific instructions on selecting alarm conditions and specifying them for automatic waveform capture, refer to the POWERLOGIC application software instruction manual.

## How it Works

At the beginning of every update cycle, the circuit monitor acquires four cycles of sample data for metering calculations (figure 6-1). During the update cycle, the circuit monitor performs metering calculations and checks for alarm conditions. If the circuit monitor sees an alarm condition, it performs any actions assigned to the alarm condition. These actions can include automatic waveform capture, forced data logs, or output relay operations. For this example, assume that automatic waveform capture has been assigned to the alarm condition. When the circuit monitor sees that an alarm condition specified for automatic waveform capture has occurred, it stores the four cycles of waveform data acquired at the beginning of the update cycle.

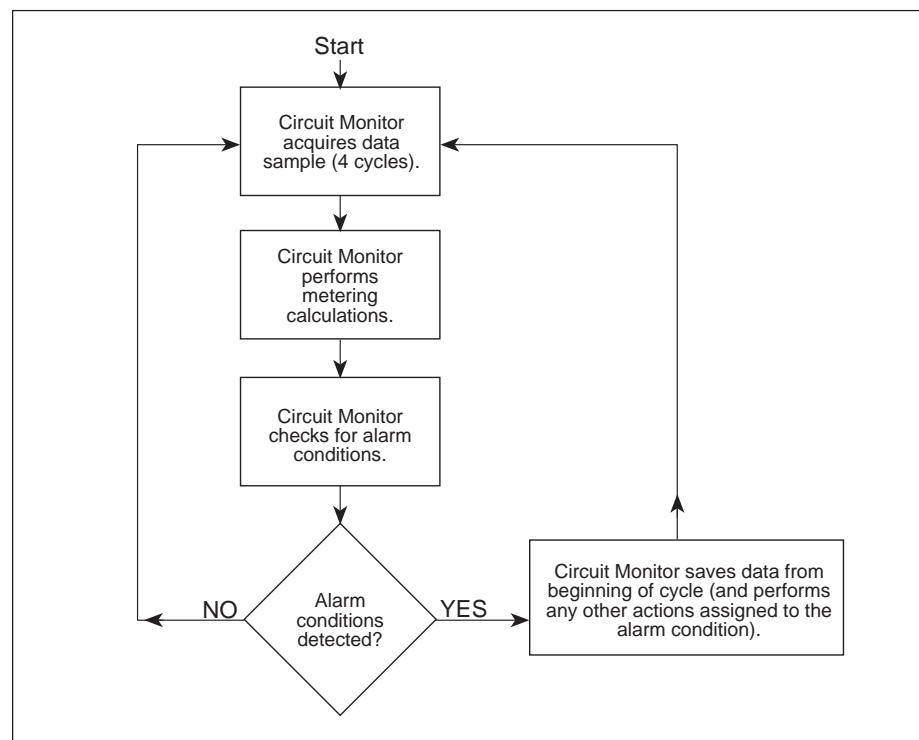

Figure 6-1: Flowchart illustrating automatic waveform capture

**Waveform Storage**

Circuit monitor model 2250 stores waveforms differently than model 2350. The lists below describe how each model stores waveforms.

**CM-2250**

- Can store only one captured waveform. Each new waveform capture (either manual or automatic) replaces the last waveform data.
- Stores the captured waveform in volatile memory—the waveform data is lost on power-loss.
- The captured waveform does not affect event log and data log storage space. The captured waveform is stored separately.

**CM-2350 (and higher)**

- Can store multiple captured waveforms.
- Stores the captured waveforms in nonvolatile memory—the waveform data is retained on power-loss.
- The number of waveforms that can be stored is based on the amount of memory that has been allocated to waveform capture. See **Memory Allocation** in **Chapter 9**.

**EXTENDED EVENT CAPTURE** Circuit monitor models CM-2250 and higher are equipped with a feature called extended event capture. By connecting the circuit monitor to an external device, such as an undervoltage relay, the circuit monitor can capture and provide valuable information on short duration events such as voltage sags and swells.

For a CM-2250, each event capture includes 12 cycles of sample data from each voltage and current input. For a CM-2350 and higher, an extended event capture can include 12, 24, 36, 48, or 60-cycles of sample data. An adjustable trigger delay lets the user adjust the number of pre-event cycles.

In a CM-2250, there are three ways to initiate a 12-cycle event capture:

- Manually, from a remote personal computer using POWERLOGIC application software
- Automatically, using an external device to trigger the circuit monitor
- Automatically, by the circuit monitor, when an alarm condition such as “Alarm #55: Over value THD voltage Phase A-B” occurs.

These methods are described below.

*Note: Models CM-2350 and higher can also trigger on high-speed events, allowing it to perform disturbance monitoring of voltage and current waveforms. See **Chapter 7** for a description of the CM-2350’s disturbance monitoring capability.*

### **Manual Event Capture**

Using POWERLOGIC application software, you can initiate a manual extended event capture from a remote personal computer. Manual event captures, which can be used for steady-state analysis, can be stored in two ways:

- 12–60 cycles of data captured at 64 samples/cycle for all voltages and currents simultaneously (12 cycles only in a CM-2250)
- 6–30 cycles of data captured at 128 samples per cycle for selected voltages and currents (CM-2350 and higher models only)

To initiate a manual capture, select a circuit monitor equipped with extended event capture, choose the desired method, and issue the **acquire** command. The circuit monitor captures the data, and the software retrieves and displays it. POWERLOGIC software lets you view all captured voltage and current waveforms up to 60 cycles, simultaneously, or zoom in on a single waveform.

For instructions on performing manual extended event capture using POWERLOGIC software, refer to the application software instruction manual.

### **Automatic Event Capture— High-Speed Trigger**

By connecting the circuit monitor to an external device, such as an undervoltage relay, the circuit monitor can capture and provide valuable information on short duration events such as voltage sags. (The circuit monitor must be equipped with an optional I/O module.)

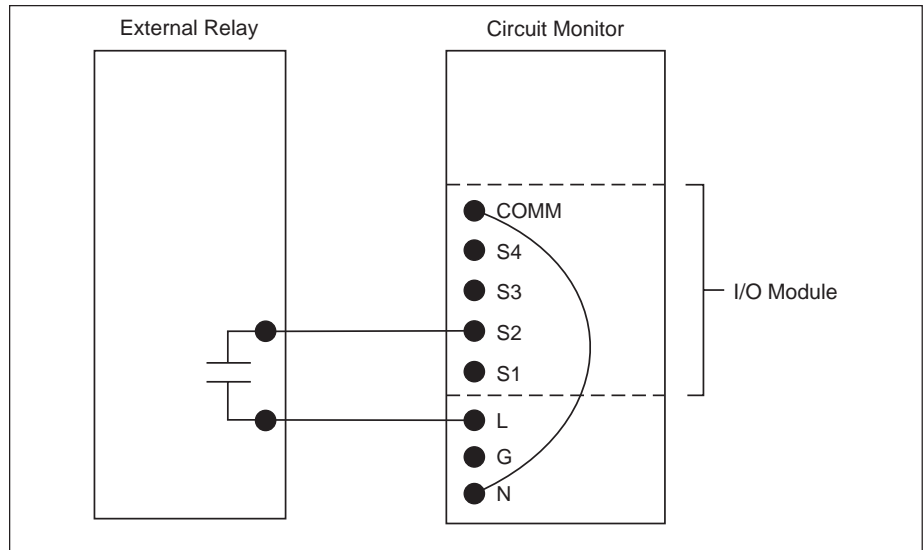

Figure 6-2: Status input S2 connected to external high-speed relay

Figure 6-2 shows a block diagram that illustrates the relay-to-circuit monitor connections. As shown in figure 6-3, the relay must be wired to status input S2 on an IOM-18 or IOM-44. Status input S2 is a high-speed input designed for this application, or any of the status inputs on an IOM-4411 or IOM-4444 can be used for high-speed event capture.

### Setting Up the Circuit Monitor

The circuit monitor must be set up for extended event capture using POWERLOGIC application software. The following is an example of setting up the circuit monitor for event capture:

1. When setting up the circuit monitor, select the alarm condition “Input S2 OFF to ON” (See **Appendix D** for a listing of alarm conditions.)
2. Select the number of cycles to be stored for the extended event capture.

For specific instructions on specifying an alarm condition for extended event capture, refer to the POWERLOGIC application software instruction bulletin.

### How it Works

The circuit monitor maintains a data buffer consisting of 64 data points per cycle, for all current and voltage inputs. As the circuit monitor samples data, this buffer is constantly updated. When the circuit monitor senses the trigger—that is, when input S2 in the above example transitions from off to on—the circuit monitor can transfer from 12 to 60 cycles of data from the buffer into the memory allocated for extended event captures.

You can specify from 2 to 10 pre-event cycles. This allows extended captures from 2 pre-event and from 10 to 58 post-event cycles, to 10 pre-event and from 2 to 50 post-event cycles. For specific instructions on setting the number of pre-event and post-event cycles, refer to the POWERLOGIC application software instruction bulletin.

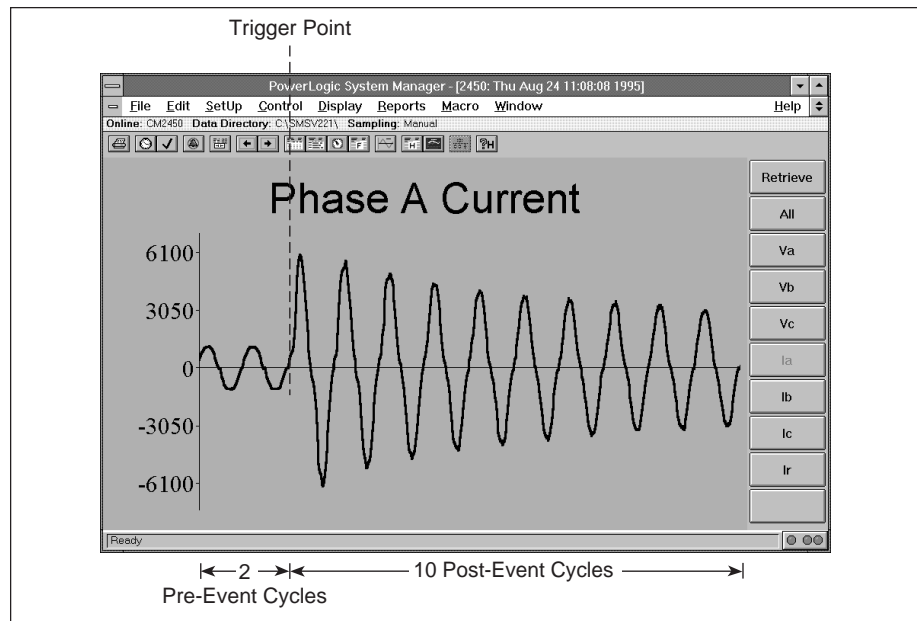

Figure 6-3: 12-cycle event capture example initiated from a high-speed input S2

Figure 6-3 shows a 12-cycle event capture. In this example, the circuit monitor was monitoring a constant load when a motor load started causing a current inrush. The circuit monitor was set up to capture 2 pre-event and 10 post-event cycles.

### Automatic Extended Capture—Initiated by a Standard Setpoint

The circuit monitor can detect over 100 alarm conditions, such as metering setpoint exceeded and status input changes (see **Chapter 4—Alarm Functions**). The circuit monitor can be set up to save from 12 to 60 cycles of waveform data associated with the update cycle during which an alarm condition occurs. The 12 to 60 cycles of captured data do not correspond with the sample data taken at the beginning of the update cycle. The captured data is taken from later in the metering update cycle; therefore, the 12 to 60 cycles of captured data may not contain the same data that triggered the standard setpoint, but rather, the data immediately following. (For automatic recording of disturbances such as sags and swells, see **Chapter 7**.)

### Setting Up the Circuit Monitor

The circuit monitor must be set up for automatic, setpoint-controlled waveform capture using POWERLOGIC application software. To set up the circuit monitor, you must do three things:

1. Select an alarm condition. (See **Appendix D** for a listing of alarm conditions.)
2. Define the setpoints.
3. Select the check box for automatic waveform capture.

Repeat these steps for the desired alarm conditions. For specific instructions on selecting alarm conditions, defining setpoints, and specifying an alarm condition for automatic waveform capture, refer to the POWERLOGIC application software instruction bulletin.

**Extended Event Capture Storage**

Circuit monitor model 2250 stores 12-cycle event captures differently than models 2350 and higher store 12 to 60 cycle event captures. The lists below describe how each model stores extended event captures.

**CM-2250:**

- Stores only one captured 12-cycle event. Each new event capture (either manual or automatic) replaces the last captured data.
- Stores the captured data in volatile memory—the data is lost on power-loss.
- The captured data does not affect event log and data log storage space. The captured waveform is stored separately.

**CM-2350 (and higher):**

- Stores multiple captured 12 to 60-cycle events.
- Stores the captured data in nonvolatile memory—the data is retained on power-loss.
- The number of extended event captures that can be stored is based on the amount of memory that has been allocated to extended event capture. See **Memory Allocation** in **Chapter 9**.





## CHAPTER 7—DISTURBANCE MONITORING

### CHAPTER CONTENTS

Introduction .....	49
Description .....	49
Operation .....	52
Multiple Waveform Setup .....	52
SMS-3000, SMS-1500, or PMX-1500 .....	52
SMS-770, SMS-700, EXP-550, or EXP-500 .....	54
Sag/Swell Alarms .....	55
Multiple Waveform Retrieval .....	56
SMS-3000, SMS-1500, or PMX-1500 .....	56
SMS-770, SMS-700, EXP-550, or EXP-500 .....	56
High-Speed Event Log Entries .....	57

### INTRODUCTION

**Chapter 6—Waveform Capture** describes using a circuit monitor to make an extended event capture, with 64 points per cycle resolution simultaneously on all channels, when triggered by an external device such as an undervoltage relay. This chapter describes how to continuously monitor for disturbances on the current and voltage inputs of circuit monitor models 2350, 2450, and 2452.

### DESCRIPTION

Models 2350, 2450, and 2452 can perform continuous monitoring of rms magnitudes of any of the metered channels of current and voltage. These calculations can be used to detect sags or swells on these channels.

Momentary voltage disturbances are becoming an increasing concern for industrial plants, hospitals, data centers, and other commercial facilities. Modern equipment used in many facilities tends to be more sensitive to voltage sags and swells, as well as momentary interruptions. POWERLOGIC Circuit Monitors can help facility engineers diagnose equipment problems resulting from voltage sags or swells, identify areas of vulnerability, and take corrective action.

The interruption of an industrial process due to an abnormal voltage condition can result in substantial costs to the operation, which manifest themselves in many ways:

- labor costs for cleanup and restart
- lost productivity
- damaged product or reduced product quality
- delivery delays and user dissatisfaction

The entire process can depend on the sensitivity of a single piece of equipment. Relays, contactors, adjustable speed drives, programmable controllers, PCs, and data communication networks are all susceptible to transient power problems. After the electrical system is interrupted or shut down, determining the cause may be difficult.

## DESCRIPTION (CONT.)

There are several types of voltage disturbances; each may have different origins and require a separate solution. For example, a momentary interruption occurs when a protective device interrupts the circuit feeding the customer's facility. Swells and overvoltages are also a concern, as they can accelerate equipment failure or cause motors to overheat. Perhaps the biggest power quality problem facing industrial and commercial facilities is the momentary voltage sag caused by faults on remote circuits.

A voltage sag is a brief (1/2 cycle to 1 minute) decrease in rms voltage magnitude. A sag is typically caused by a remote fault somewhere on the power system, often initiated by a lightning strike. In figure 7-1, the fault not only causes an interruption to plant D, but also results in voltage sags to plants A, B, and C. Thus, system voltage sags are much more numerous than interruptions, since a wider part of the distribution system is affected. And, if reclosers are operating, they may cause repeated sags. The waveform in figure 7-2 shows the magnitude of a voltage sag, which persists until the remote fault is cleared.

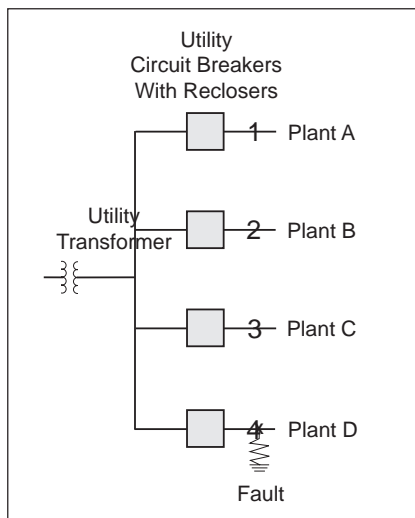

Figure 7-1: A fault near plant D that is cleared by the utility circuit breaker can still affect plants A, B, and C, resulting in a voltage sag

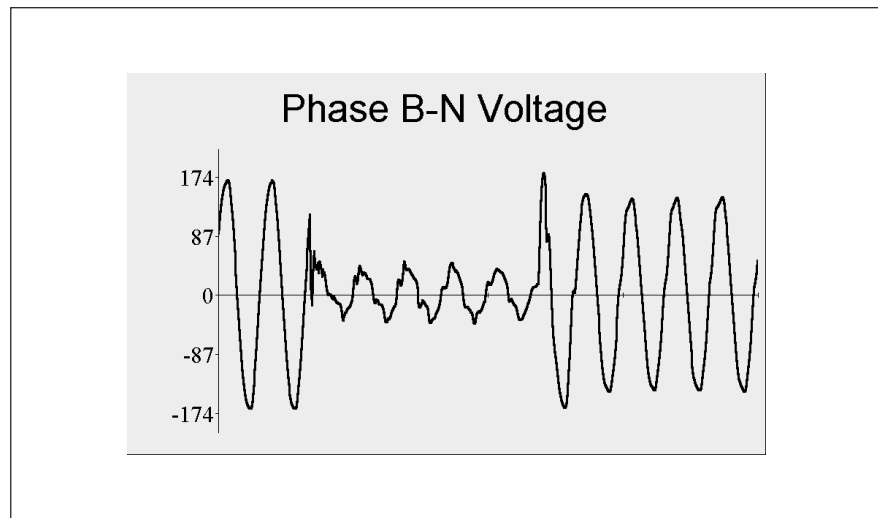

Figure 7-2: Voltage sag caused by a remote fault and lasting 5 cycles

The disturbance monitoring capabilities of the CM-2350, CM-2450, and CM-2452 can be used to:

- Identify number of sags/swells/interruptions for evaluation
- Compare actual sensitivity of equipment to published standards
- Compare equipment sensitivity of different brands (contactor dropout, drive sensitivity, etc.)
- Distinguish between equipment failures and power system related problems

- Diagnose mysterious events such as equipment failure, contactor dropout, computer glitches, etc.
- Determine the source (user or utility) of sags/swells
- Develop solutions to voltage sensitivity-based problems using *actual* data
- Accurately distinguish between sags and interruptions, with accurate time/date of occurrence
- Use waveform to determine exact disturbance characteristics to compare with equipment sensitivity
- Provide accurate data in equipment specification (ride-through, etc.)
- Discuss protection practices with serving utility and request changes to shorten duration of potential sags (reduce interruption time delays on protective devices)
- Justify purchase of power conditioning equipment
- Work with utility to provide alternate “stiffer” services (alternate design practices)

Table 7-1 below shows the capability of the CM-2350, CM-2450, and CM-2452 to measure power system electromagnetic phenomena as defined in *IEEE Recommended Practice for Monitoring Electric Power Quality*.

**Table 7-1**  
**Circuit Monitor Electromagnetic**  
**Phenomena Measurement Capability**

Category	Capability
Transients <sup>①</sup>	
Impulsive	N/A
Oscillatory	N/A
Short Duration Variations	
Instantaneous	✓
Momentary	✓
Temporary	✓
Long Duration Variations	✓
Voltage Imbalance	✓
Waveform Distortion <sup>②</sup>	✓
Voltage Fluctuations	✓
Power Frequency Variations	✓

<sup>①</sup> Circuit monitor not intended to detect phenomena in this category.

<sup>②</sup> Through the 31st harmonic.

## OPERATION

The circuit monitor calculates rms magnitudes, based on 16 data points per cycle, every 1/2 cycle. This ensures that even single cycle duration rms variations are not missed. When the circuit monitor detects a sag or swell, it can perform the following actions:

- The event log can be updated with a sag/swell pickup event date/time stamp with 1 millisecond resolution, and an rms magnitude corresponding to the most extreme value of the sag or swell during the event pickup delay.
- An event capture consisting of up to five back-to-back 12-cycle recordings can be made, for a maximum of 60 continuous cycles of data. The event capture has a resolution of 64 data points per cycle on all metered currents and voltages.
- A forced data log entry can be made in up to 14 independent data logs.
- Any optional output relays can be operated upon detection of the event.
- At the end of the disturbance, these items are stored in the Event Log: a dropout time stamp with 1 millisecond resolution, and a second rms magnitude corresponding to the most extreme value of the sag or swell.
- The front panel can indicate, by a flashing Alarm LED, that a sag or swell event has occurred. A list of up to 10 of the prior alarm codes can be viewed in the P1 Log from the circuit monitor's front panel.

In addition to these features, the CM-2350, CM-2450, and CM-2452 include expanded non-volatile memory for logging. Using POWERLOGIC application software, the user can choose how to allocate the nonvolatile memory among the 14 data logs, the event log, multiple 4-cycle waveform captures and multiple extended event captures.

## MULTIPLE WAVEFORM SETUP

You can configure the CM-2350, CM-2450, and CM-2452 to record up to five back-to-back 12-cycle waveform captures. This allows you to record 60 cycles of continuous data on all current and voltage inputs, with 64 points per cycle resolution.

### SMS-3000, SMS-1500, or PMX-1500

To set up the extended waveform capture using SMS-3000, SMS-1500, or PMX-1500, follow these steps:

1. In the Onboard Data Storage screen (figure 7-3), select the number of cycles for extended capture from the pull-down menu.
2. Allocate the amount of memory to be used for extended waveform capture by specifying the number of extended waveform captures to be stored.

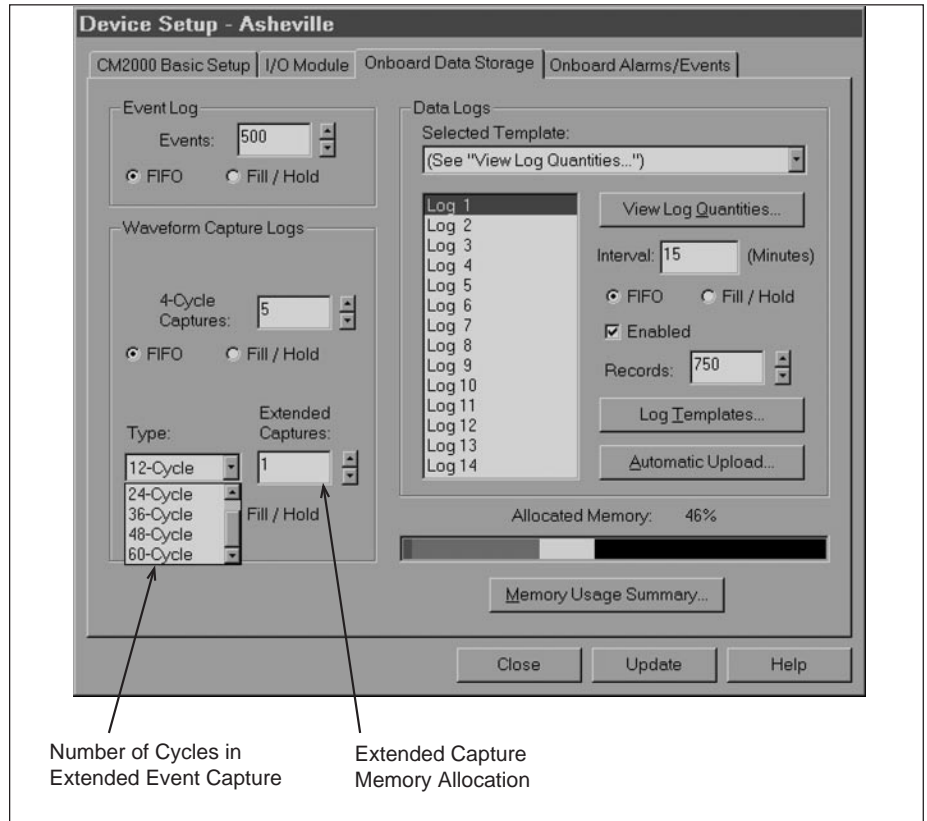

Number of Cycles in  
Extended Event Capture

Extended Capture  
Memory Allocation

Figure 7-3: POWERLOGIC System Manager SMS-3000 Onboard Data Storage dialog box

**SMS-770, SMS-700,  
EXP-550, or EXP-500**

To configure the number of back-to-back 12-cycle recordings triggered by a single event, write a 1, 2, 3, 4, or 5 to register 7298 (see table 7-2 below). You must then allocate the onboard memory as shown in tables 7-3 and 7-4 to support multiple back-to-back 12-cycle waveform captures. Allocate onboard memory using the Onboard Data Storage setup screen (figure 7-4). Once the memory is properly allocated, you must perform a file “Resize/Clear All.” For information on register writes and file “Resize/Clear All,” refer to the appropriate POWERLOGIC application software instruction bulletin.

**Table 7-2  
Multiple 12-Cycle Waveform Capture**

No. of Back-to-Back 12-Cycle Waveform Captures per Trigger	No. of Continuous Cycles Recorded per Trigger	Required Value in Register 7298
1	12	1
2 <sup>①</sup>	24	2
3 <sup>①</sup>	36	3
4 <sup>①</sup>	48	4
5 <sup>①</sup>	60	5

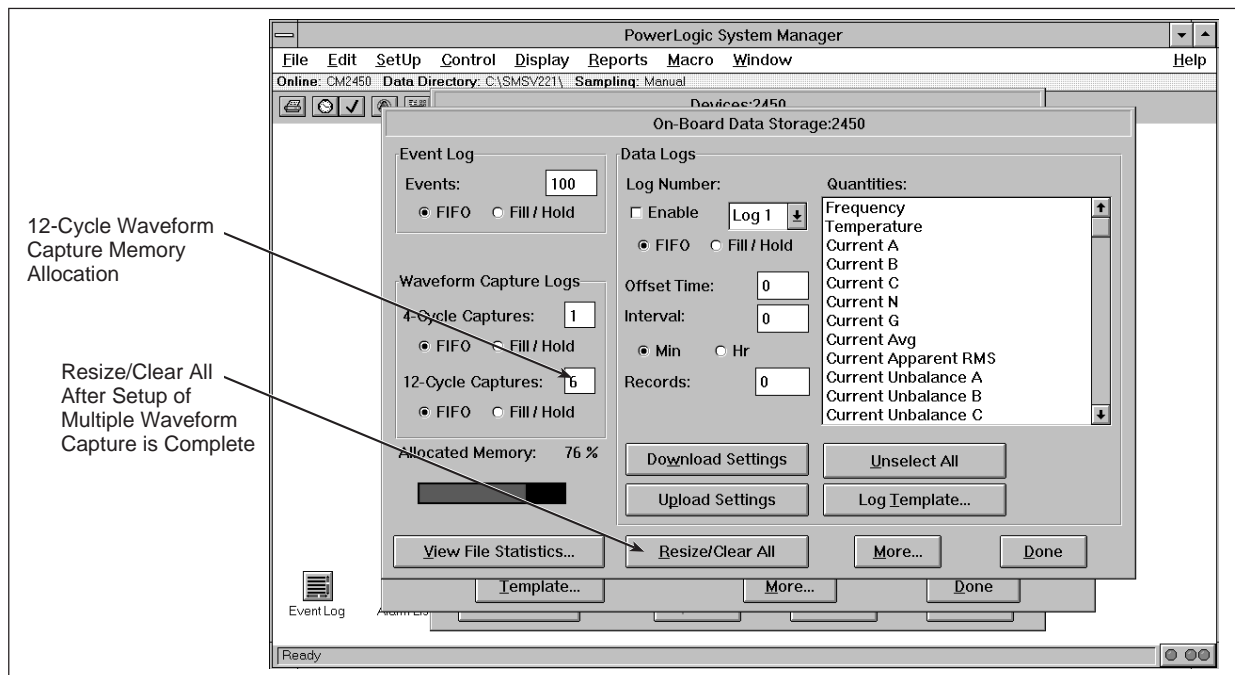

Figure 7-4: POWERLOGIC System Manager™ SMS-770 Onboard Data Storage setup dialog box

① Requires circuit monitor firmware version 15.002 or higher.

**Table 7-3**  
**CM-2350 and CM-2450 12-Cycle Waveform Capture Memory Allocation**

No. of Back-to-Back 12-Cycle Waveform Captures Per Trigger	Legal Entries for 12-Cycle Waveform Capture Memory Allocation	Max. No. of Triggered Events Stored
1	Multiples of 1: 1, 2, 3...8	8
2 <sup>①</sup>	Multiples of 2: 2, 4, 6, 8	4
3 <sup>①</sup>	Multiples of 3: 3, 6	2
4 <sup>①</sup>	Multiples of 4: 4, 8	2
5 <sup>①</sup>	Multiple of 5: 5	1

**Table 7-4**  
**CM-2452 12-Cycle Waveform Capture Memory Allocation**

No. of Back-to-Back 12-Cycle Waveform Captures Per Trigger	Legal Entries for 12-Cycle Waveform Capture Memory Allocation	Max. No. of Triggered Events Stored
1	Multiples of 1: 1, 2, 3...29	29
2 <sup>①</sup>	Multiples of 2: 2, 4, 6...28	14
3 <sup>①</sup>	Multiples of 3: 3, 6, 9...27	9
4 <sup>①</sup>	Multiples of 4: 4, 8, 12...28	7
5 <sup>①</sup>	Multiples of 5: 5, 10, 15, 20, 25	5

As explained in chapter 6, the event capture has a user-programmable number of pre-event cycles ranging from 2 to 10 cycles. This allows you to tailor the event capture for more or less pre-event data. On event captures consisting of multiple 12-cycle recordings, the pre-event cycles apply only to the first 12-cycle waveform of the series.

## SAG/SWELL ALARMS

POWERLOGIC application software can be used to set up each of the sag/swell alarms. For each alarm, the user programs the following data:

- Sag/swell alarm priority
- Pickup setpoint in amps or volts
- Pickup delay in cycles
- Dropout setpoint in amps or volts
- Dropout delay in cycles
- Data and waveform logging instructions
- Relay output actions

*Note: Relays which are specified to be operated by high speed status input events should not be operated by standard events or high speed sag/swell events. Unpredictable relay operation will result.*

<sup>①</sup> Requires circuit monitor firmware version 15.002 or higher.

**MULTIPLE WAVEFORM RETRIEVAL**

POWERLOGIC application software can be used to retrieve multiple waveform information for later analysis. When a set of multiple continuous 12-cycle waveform captures are triggered, they are stored in the circuit monitor as individual 12-cycle recordings.

**SMS-3000, SMS-1500, or PMX-1500**

Using SMS-3000, SMS-1500, or PMX-1500 software, you can retrieve a continuous 12–60 cycle extended event capture (figure 7-5).

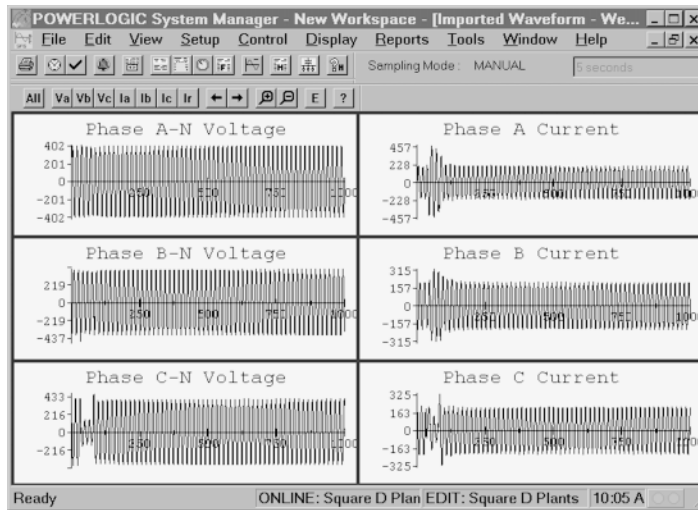

Figure 7-5: 60-cycle extended event capture displayed in SMS-3000

**SMS-770, SMS-700, EXP-550, or EXP-500**

You can retrieve and display the individual 12-cycle waveform captures (which comprise the extended event capture) using SMS-700, SMS-770, EXP-550, or EXP-500. You can also manually acquire a set of continuous 12-cycle waveform captures using the “retrieve existing on board waveform capture” option (figure 7-6).

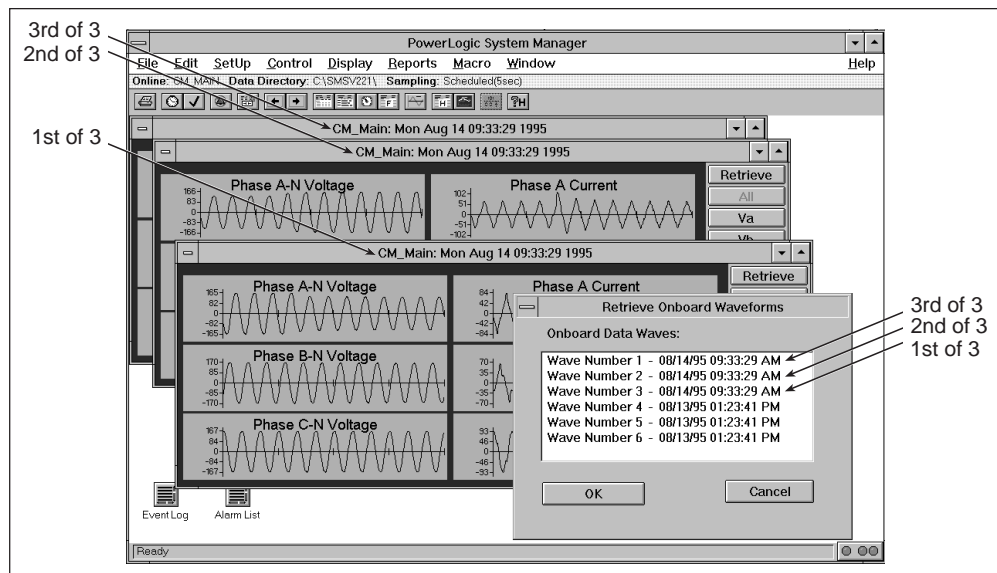

Figure 7-6: Three back-to-back 12-cycle waveform captures of a  $V_{a-n}$  sag



*Note: Whenever the 12-cycle waveform capture is configured for two or more back-to-back waveform captures, a set of waveform captures can be triggered manually with POWERLOGIC application software. However, to retrieve the set, the “retrieve existing onboard 12-cycle waveform capture” option should be used.*

## HIGH-SPEED EVENT LOG ENTRIES

Event log entries 1 and 2 are detailed below and illustrated in figure 7-7.

Event Log Entry 1—For high-speed events, the value stored in the event log at the end of the pickup delay is the furthest excursion from normal during the pickup delay period  $t1$ . This is calculated using 16 data point rms calculations.

Event Log Entry 2—The value stored in the event log at the end of the dropout delay is the furthest excursion from normal during both periods  $t1$  and  $t2$  from the start of the pickup delay to the end of the dropout delay.

The time stamps for the pickup and dropout reflect the actual duration of these periods.

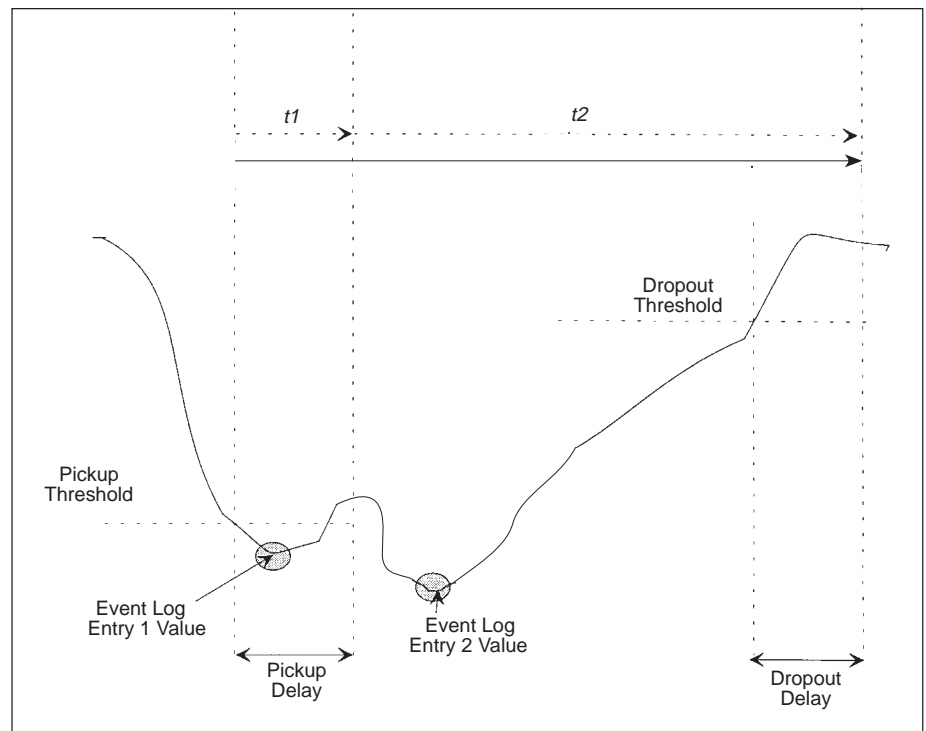

Figure 7-7: High speed event log entries



## CHAPTER 8—CM-2450, CM-2452 WITH PROGRAMMING LANGUAGE

### INTRODUCTION

Circuit monitor models CM-2450 and CM-2452 are designed to run customized programs written in the circuit monitor programming language. This programming language provides you with the application flexibility to adapt the CM-2450 or CM-2452 to your specialized needs. Programs can be designed to work with all other circuit monitor features, extending the overall capabilities of the device. A sample CM-2450 program is available from Square D that includes customized features for enhanced data logging. Contact POWERLOGIC Engineering Services for information on using the CM-2450 for other applications.

### DESCRIPTION

The CM-2450 circuit monitor programming language uses an easy-to-understand set of programming commands similar to a compiled "BASIC" language. The programming language includes capabilities such as:

- scheduled tasks
- event tasks (based on undervoltage, over kW...)
- math functions: Add, subtract, multiply, divide, sine, cosine, square root...
- support for various data types: 16-bit signed registers, longs, floats, power factor, date/time...
- logical operations: AND, OR, XOR, NOT, shift...
- for...next loops, nested IF...Else statements, =, <, >, <>, <+, >=
- Subroutine calls
- 1000 nonvolatile SY/MAX read/write registers
- 2000 virtual registers for scratch pad area
- support for tables of up to 256 items

The programs are developed using an ASCII text editor such as DOS "Edit" and saved as ".SRC" files. A circuit monitor programming language compiler is then used to process the text file, looking for syntax errors or illegal commands. Any errors that are found are listed in a report detailing the errors. After program errors are corrected, the compiler generates a ".HEX" file which can be downloaded into the circuit monitor using the downloadable firmware utility program. Programs that are downloaded into the circuit monitor are secure; they cannot be uploaded. If changes to a program are desired, the new program can be modified from the original program text file, re-compiled, and written over the previous program as a new application.

## **APPLICATION EXAMPLES**

Examples of applications where the CM-2450 can be very valuable are as follows:

- metering of specialized utility rate structures
- data reduction using smart data logging
- automatic monthly logging of kWh and Peak Demand
- synchronization of Demand Intervals to Time of Day
- statistical profile analysis of metered quantities
- CBEMA power quality analysis
- calculations for IEEE-519 verification
- metering of combined utilities: gas, water, steam, electric
- non-critical control output decisions such as Load Control or Power Factor Correction, based on multiple conditions, e.g., Time of Day and Input Status

*Note: Apply the circuit monitor appropriately as a programmable power monitoring device, not as a primary protective device.*

## **DEVELOPER'S KIT**

Purchasers of circuit monitor models CM-2450 or CM-2452 can receive a program developer's kit at no additional charge. The developer's kit includes an instruction bulletin, program compiler, and sample programs, enabling you to create your own CM-2450 programs. Contact your local Square D representative or PMO Technical Support to order the developer's kit.

## CHAPTER 9—ADVANCED TOPICS

### CHAPTER CONTENTS

The Command Interface .....	61
Command Codes .....	62
Operating Relays Using the Command Interface .....	64
Setting Up Relays for Remote (External) Control .....	64
Energizing a Relay .....	64
De-Energizing a Relay .....	64
Setting Up Relays for Circuit Monitor (Internal) Control .....	65
Overriding an Output Relay .....	65
Releasing an Overridden Relay .....	65
Setting Scale Factors For Extended Metering Ranges .....	66
Setting The Date and Time Using the Command Interface .....	69
Memory Allocation .....	69
Memory Example .....	71
How Power Factor is Stored .....	71
Changing the VAR Sign Convention .....	72
Conditional Energy .....	73
Command Interface Control .....	73
Status Input Control .....	73
Incremental Energy .....	74
Using Incremental Energy .....	74
Changing the Demand Calculation Method .....	75
Changing to the Block/Rolling Method .....	75
Setting Up a Demand Synch Pulse Input .....	75
Controlling the Demand Interval Over the Communications Link .....	76
Setting Up Individual Harmonic Calculations .....	77
Status Input Pulse Demand Metering .....	78
Pulse Counting Example .....	78

**THE COMMAND INTERFACE** The circuit monitor provides a command interface that can be used to perform various operations such as manual relay operation.

*To use the command interface, do the following:*

1. Write related parameters to the command parameter registers—7701–7709. (Some commands require no parameters. For these commands, write the command code only to register 7700.)
2. Write a command code to the circuit monitor’s command interface register (7700).

## Command Codes

The following is a listing of command codes that can be written to the command interface register (7700) and to the command interface parameter registers (7701–7709).

<u>Code</u>	<u>Parameter(s)</u>	<u>Description</u>	<u>Reset Req'd</u>
1110	None	Resets the circuit monitor.	N/A
1310	Sec, Min, Hr, Day, Mo, Yr	Command code to set date and time.	N
2110	Scale Factors A–E	Change scale factors A–E and reset min/max registers/file. Then reset unit.	N
2120	CT ratio correction factors A, B, C, N	Change CT ratio correction factors	Y
2130	PT ratio correction factors A, B, C	Change PT ratio correction factors	Y
2310	Unit Address	Change unit's address to the address specified and reset unit	N
2320	Baud Rate	Change unit's baud rate to the baud rate specified and reset unit	N
2325	None	Set communication to even parity (default)	Y
2326	None	Set communication to no parity	Y
2330	None	Enable unit #01's response to the SY/MAX enquire transmission (default)	N
2331	None	Disable unit #01's response to the SY/MAX enquire transmission	N
2340	None	Set control of conditional energy to status inputs (default)	N
2341	None	Set control of conditional energy to command Interface	N
2350	None	Enable front panel comm port (default)	N
2351	None	Disable front panel comm port	N
2360	None	Enable front panel setup (default)	N
2361	None	Disable front panel setup	N
2370	None	Set normal phase rotation to ABC (default)	N
2371	None	Set normal phase rotation to CBA	N
3310	Bit Map Relay Designation	Place specified relays under external control (default)	N
3311	Bit Map Relay Designation	Place specified relays under internal control	N
3320	Bit Map Relay Designation	De-energize designated relays per specified bit map	N
3321	Bit Map Relay Designation	Energize designated relays per specified bit map	N
3340	Bit Map Output Designation	Release specified relays from override control	N
3341	Bit Map Output Designation	Place specified relays under override control	N

<b>Code</b>	<b>Parameter(s)</b>	<b>Description</b>	<b>Reset Req'd</b>
3390	Bit Map Input Designation	Set control of conditional energy to indicated status inputs	N
4110	None	Reset Min/Max	N
4310	None	Set VAr sign convention to CM1 convention (default)	Y
4311	None	Set VAr sign convention to alternate convention	Y
4910	None	Trigger 4-cycle waveform capture	N
4911	None	Trigger 12-cycle waveform capture	N
5110	None	Reset Peak Demand Currents/K Factors/Generic Demand	N
5112	None	Reset Peak and MinimumGeneric Demand quantities	N
5120	None	Reset Peak Demand Powers and associated average Power Factors	N
5310	None	Set power demand method to thermal (default)	Y
5311	None	Set power demand method to block/rolling	Y
5320	None	Set external demand synch source to input 1	N
5321	None	Set external demand synch source to the command interface	N
5910	None	Start new demand interval	N
5920	None	Set new Status Input Pulse Demand Interval	N
6210	None	Clear all accumulated energies	N
6220	None	Clear all conditional energies	N
6310	None	Set energy accumulation method to absolute	N
6311	None	Set energy accumulation method to signed	N
6320	None	Disable conditional energy accumulation	N
6321	None	Enable conditional energy accumulation	N
6330	None	Set reactive energy and demand method to include only the fundamental component	N
6331	None	Set reactive energy and demand method to include the both fundamental and harmonic components	N
6910	None	Start new incremental energy interval	N
7510	Bit Map	Trigger Data Log Entry	N

## OPERATING RELAYS USING THE COMMAND INTERFACE

By writing commands to the command interface, you can control circuit monitor relay outputs. This section tells how to operate the relay outputs. See **Appendix B**, registers 2500–2521, for information on relay output configuration.

### Setting Up Relays for Remote (External) Control

To set up the circuit monitor for remote (external) relay operation, you must configure the circuit monitor for remote relay control.

*To configure the circuit monitor for remote relay control:*

1. Write a bitmap (see below) to the command parameter register, specifying the relays to be setup for remote control.

<b>Reg #</b>	<b>Value</b>	<b>Description</b>
7701	Bitmap	Bitmap corresponding to relays to be placed under manual control. Bit 1 corresponds to KYZ, Bit 2 corresponds to Relay 1, Bit 3 corresponds to relay 2, Bit 4 corresponds to relay 3.

2. Write a command code (3310) to the circuit monitor's command interface register (7700).

7700	3310	Command code to configure relay for remote (external) control
------	------	---

### Energizing a Relay

*To energize a relay, do the following:*

1. Write a bitmap (see below) to the command parameter register, specifying the relays to be energized.

<b>Reg #</b>	<b>Value</b>	<b>Description</b>
7701	Bitmap	bitmap corresponding to relays to be energized. Bit 1 corresponds to KYZ, Bit 2 corresponds to Relay 1, Bit 3 corresponds to relay 2, Bit 4 corresponds to relay 3.

2. Write a command code (3321) to the circuit monitor's command interface register (7700).

7700	3321	Command code to energize relay
------	------	--------------------------------

### De-Energizing a Relay

*To de-energize a relay, do the following:*

1. Write a bitmap (see below) to the command parameter register, specifying the relays to be de-energized.

<b>Reg #</b>	<b>Value</b>	<b>Description</b>
7701	Bitmap	bitmap corresponding to relays to be de-energized. Bit 1 corresponds to KYZ, Bit 2 corresponds to Relay 1, Bit 3 corresponds to relay 2, Bit 4 corresponds to relay 3.

2. Write a command code (3320) to the circuit monitor's command interface register (7700).

7700	3320	Command code to de-energize relay
------	------	-----------------------------------



### Setting Up Relays for Circuit Monitor (Internal) Control

For the circuit monitor to automatically control relays based on alarm conditions or as a pulse initiator output, you must configure the relays for circuit monitor (internal) control.

*To configure relays for circuit monitor (internal) control, do the following:*

1. Write a bitmap (see below) to the command parameter register, specifying the relays to be setup for internal control.

<b>Reg #</b>	<b>Value</b>	<b>Description</b>
7701	Bitmap	Bitmap corresponding to relays to be placed under internal control. Bit 1 corresponds to KYZ, Bit 2 corresponds to Relay 1, Bit 3 corresponds to relay 2, Bit 4 corresponds to relay 3.

2. Write a command code (3311) to the circuit monitor's command interface register (7700).

7700	3311	Command code to configure relay for internal control
------	------	--

### Overriding an Output Relay

It is possible to override a circuit monitor output relay set up for circuit monitor (internal) control. Once overridden, the specified relays will respond to manual control.

*To override relays, do the following:*

1. Write a bitmap (see below) to the command parameter register, specifying the relays to be overridden.

<b>Reg #</b>	<b>Value</b>	<b>Description</b>
7701	Bitmap	Bitmap corresponding to relays to be placed under override control. Bit 1 corresponds to KYZ, Bit 2 corresponds to Relay 1, Bit 3 corresponds to relay 2, Bit 4 corresponds to relay 3.

2. Write a command code (3341) to the circuit monitor's command interface register (7700).

7700	3341	Command Code to place relay under override control.
------	------	---

### Releasing an Overridden Relay

To return an overridden relay to circuit monitor (internal) control, you must release the override.

*To release the override, do the following:*

1. Write a bitmap (see below) to the command parameter register, specifying the relays to be released from override.

<b>Reg #</b>	<b>Value</b>	<b>Description</b>
7701	Bitmap	Bitmap corresponding to relays to be released from override control. Bit 1 corresponds to KYZ, Bit 2 corresponds to Relay 1, Bit 3 corresponds to relay 2, Bit 4 corresponds to relay 3.

2. Write a command code (3340) to the circuit monitor's command interface register (7700).

7700	3340	Command Code to release overridden relays.
------	------	--

## **SETTING SCALE FACTORS FOR EXTENDED METERING RANGES**

The circuit monitor stores instantaneous metering data in single registers. Each register has a maximum range of 32,767. In order to meter extended ranges, current, voltage, and power readings can accommodate multipliers other than one. Multipliers can be changed from the default value of 1 to other values such as 10, 100, or 1000. These scale factors are automatically selected for the user when setting up the circuit monitor, either from the front panel or using POWERLOGIC application software.

The circuit monitor stores these multipliers as scale factors. A scale factor is the multiplier expressed as a power of 10. For example, a multiplier of 10 is represented as a scale factor of 1, since  $10^1=10$ ; a multiplier of 100 is represented as a scale factor of 2, since  $10^2=100$ .

If the circuit monitor displays “-OFLO-” for any reading, the scale factor may need to be changed to bring the reading back into range. For example, since a circuit monitor register cannot store a number as large as 138,000, a 138 kV system requires a multiplier of 10. 138,000 is converted to  $13,800 \times 10$ . The circuit monitor stores this value as 13,800 with a scale factor of 1 (since  $10^1=10$ ). The circuit monitor front panel would display the value as 138.00 with the KILO units LED lit.

Scale factors are arranged in scale groups. The abbreviated register list in Appendix B shows the scale group associated with each metered value.

The command interface can be used to change scale factors on a group of metered values. The procedure on the following page tells how.

### **Notes:**

- *It is strongly recommended that the default scale factors which are automatically selected by POWERLOGIC hardware and software not be changed.*
- *When using custom software to read circuit monitor data over the communications link, you must account for these scale factors. To correctly read any metered value with a scale factor other than 0, multiply the register value read by the appropriate power of 10.*
- *When you change a scale factor, all min/max values are reset.*

**Setting Scale Factors (cont.)** *To change scale factors, do the following:*

1. Determine the required scale factors

There are 5 scale groups. The desired scale factor for each group must be determined. The following is a listing of the available scale factors for each of the 5 user defined scale groups. The factory default for each scale group is 0. If you need either an extended range or more resolution, you can select any of the available scale factors to suit your need.

## Scale Group A—Phase Current

	<u>Scale Factor</u>
Amps 0–327.67 A	-2
0–3276.7 A	-1
0–32767 A	0 (default)

## Scale Group B—Neutral Current

Amps 0–327.67 A	-2
0–3276.7 A	-1
0–32767 A	0 (default)
0–327.67 kA	1

## Scale Group C—Ground Current

Amps 0–327.67 A	-2
0–3276.7 A	-1
0–32767 A	0 (default)
0–327.67 kA	1

## Scale Group D—Voltage, L-L, L-N

Voltage 0–3276.7 V	-1
0–32767 V	0 (default)
0–327.67 kV	1
0–3276.7 kV	2

## Scale Group E—Power kW, kVAR, kVA

Power 0–32.767 kW, kVAR, kVA	-3
0–327.67 kW, kVAR, kVA	-2
0–3276.7 kW, kVAR, kVA	-1
0–32767 kW, kVAR, kVA	0 (default)
0–327.67 MW, MVAR, MVA	1
0–3276.7 MW, MVAR, MVA	2
0–32767 MW, MVAR, MVA	3

2. Using POWERLOGIC application software, read the existing scale factors from registers 2020-2024 and write them down.

Register 2020	Scale Group A
Register 2021	Scale Group B
Register 2022	Scale Group C
Register 2023	Scale Group D
Register 2024	Scale Group E

3. Make note of the changes required to the scale groups.

4. Write the appropriate values (see below) to a series of command parameter registers, one for each scale group.

<u>Reg No.</u>	<u>Value</u>	<u>Description</u>
7701–7705	Scale Factors	Scale Group A—write to reg. 7701 Scale Group B—write to reg. 7702 Scale Group C—write to reg. 7703 Scale Group D—write to reg. 7704 Scale Group E—write to reg. 7705
Scale Group A: Ammeter Per Phase		-2 = multiplier of 0.01 -1 = multiplier of 0.10 0 = multiplier of 1.00 (default) 1 = multiplier of 10.0
Scale Group B: Ammeter Neutral		-2 = multiplier of 0.01 -1 = multiplier of 0.10 0 = multiplier of 1.00 (default) 1 = multiplier of 10.0
Scale Group C: Ammeter Ground		-2 = multiplier of 0.01 -1 = multiplier of 0.10 0 = multiplier of 1.00 (default) 1 = multiplier of 10.0
Scale Group D: Voltmeter		-1 = multiplier of 0.10 0 = multiplier of 1.00 (default) 1 = multiplier of 10.0 2 = multiplier of 100.
Scale Group E: kWattmeter, kVarmeter, kVA		-3 = multiplier of 0.001 -2 = multiplier of 0.01 -1 = multiplier of 0.10 0 = multiplier of 1.00 (default) 1 = multiplier of 10.0 2 = multiplier of 100. 3 = multiplier of 1000 4 = multiplier of 10,000 5 = multiplier of 100,000
Scale Group F: Frequency (Determined by CM)		-2 = multiplier of 0.01 (for 50/60 Hz) -1 = multiplier of 0.10 (for 400 Hz)

5. Write a command code (2110) to the circuit monitor's command interface register (7700).

## SETTING THE DATE AND TIME USING THE COMMAND INTERFACE

The command interface can be used to set the date and time.

To set the date and time, do the following:

1. Write values to a series of command parameter registers, one for each time parameter, SEC, MO, DA, HR, MN, YR.

Reg No.	Value	Description
7701–7706	Sec, min, hr day, mo, yr	Secs corresponds to Register 7701 Mins corresponds to Register 7702 Hours corresponds to Register 7703 Day corresponds to Register 7704 Month corresponds to Register 7705 Year corresponds to Register 7706

2. Write a command code (1310) to the circuit monitor's command interface register (7700).

Reg No.	Value	Description
7700	1310	Command code to set date and time.

## MEMORY ALLOCATION

This section describes memory allocation for nonvolatile *logging* memory only. It does not apply to nonvolatile memory used to store critical values such as setup parameters, min/max values, and energy and demand values. In all circuit monitor models, these critical values are stored in a separate nonvolatile memory area.

Circuit monitors are available with different amounts of nonvolatile logging memory. Depending on the circuit monitor model, the available nonvolatile logging memory must be allocated among an event log, 1 to 14 data logs, a waveform capture log, and an extended event capture log. Specifics for each model are described below.

**CM-2050**—Provides no nonvolatile logging memory.

**CM-2150, CM-2250**—Available nonvolatile logging memory must be allocated among an event log and 1 to 14 data logs.

**CM-2350, CM-2450, CM-2452**—Available nonvolatile logging memory must be allocated among an event log, 1 to 14 data logs, a waveform capture log, and an extended event capture log.

When using POWERLOGIC application software to set up a circuit monitor, the choices you make for the items listed below directly affect the amount of memory used:

- The number of data log files (1 to 14)
- The quantities logged in each entry (1 to 97), for each data log file
- The maximum number of entries in each data log file
- The maximum number of events in the event log file
- The maximum number of waveform captures in the waveform capture file
- The maximum number of extended event captures in the extended event capture file

The number you can enter for each of the above items depends on the amount of the memory that is still available. The amount of memory still available depends on the numbers you've already assigned to the other items.

Figure 9-1 below shows how the memory might be allocated in a CM-2350. In this figure, the user has set up a waveform capture log, an extended event capture log, an event log, and three data logs (two small logs, and one larger log). Of the total available nonvolatile memory, about 25% is still available. If the user decided to add a fourth data log file, the file could be no larger than the space still available—25% of the circuit monitor's total storage capacity. If the fourth file had to be larger than the space still available, the user would have to reduce the size of one of the other files to free up the needed space.

POWERLOGIC System Manager Software indicates the memory allocation statistics in the On-Board Data Storage dialog box shown in figure 7-3, page 53, and figure 7-4, page 54. The display uses color coding to show the space devoted to each type of log file along with the space still available. For instructions on setting up log files using POWERLOGIC software, refer to the instruction bulletin included with the software.

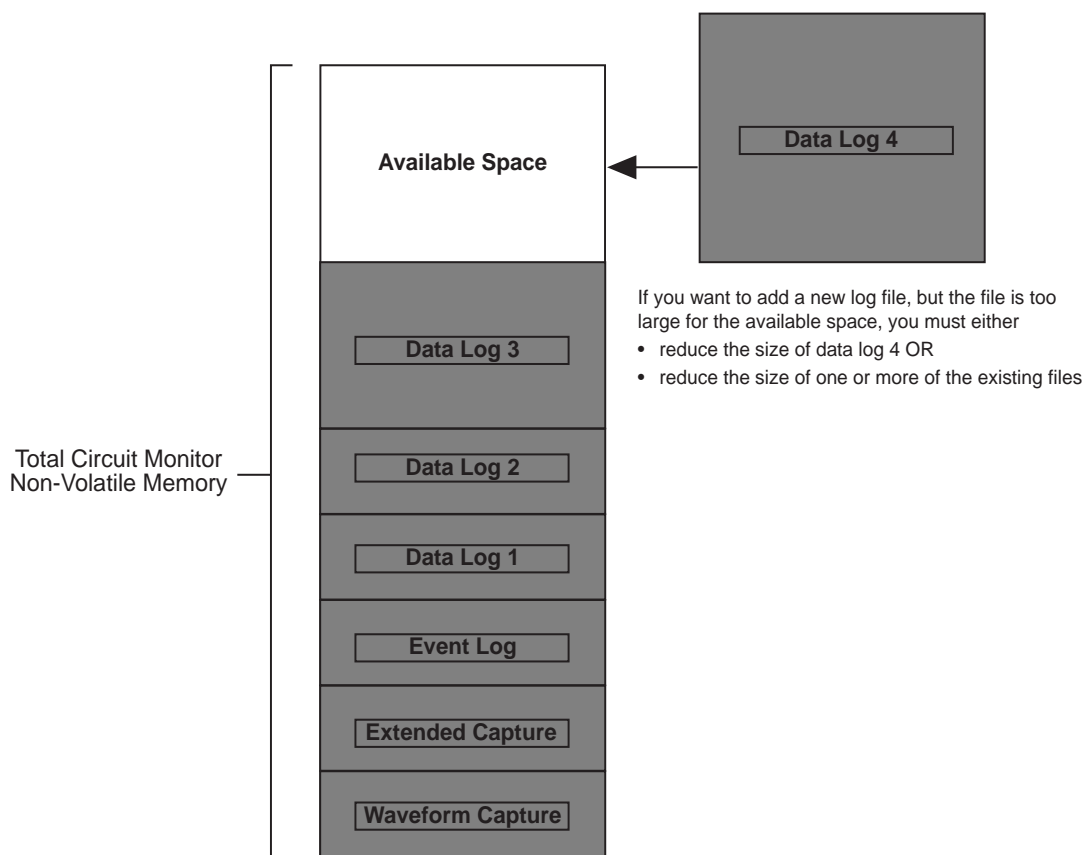

Figure 9-1: Memory allocation example (CM-2350)

### Memory Example

Table 9-1 shows how a user might configure the available memory for various circuit monitor models. In this example, the circuit monitors have been set up with one data log that stores the following data hourly: 3-phase average amps, volts (L-L, L-N), PF, kW, kVAR, frequency, 3-phase demand for amps, kW, kVA, kWh and kVARH.

The circuit monitors store waveform captures and extended event captures as follows:

- The CM-2250 can store only one waveform capture and one 12-cycle event capture. It stores these in *volatile* memory; therefore, they do not reduce the amount of nonvolatile memory available for event and data logs.
- The CM-2350 can store multiple waveform captures and extended event captures. It stores these in *nonvolatile* memory; therefore, they do affect the amount of nonvolatile memory available for event and data logs.

For specific instructions on calculating log file sizes, see **Appendix C—Calculating Log File Sizes**.

**Table 9-1**  
**Memory Configuration Example**

Typical Standard Memory Configuration <sup>①</sup>					
	CM-2050	CM-2150 <sup>③</sup>	CM-2250 <sup>③</sup>	CM-2350/2450 <sup>③</sup>	CM-2452 <sup>⑤</sup>
Event Log	N/A	500 Events	500 Events	500 Events	1500 Events
1 Data Log	N/A	40 Days	40 Days	40 Days	120 Days
Waveform Captures <sup>②</sup>	N/A	N/A	1	3 <sup>④</sup>	9 <sup>⑤</sup>
Event Captures <sup>②</sup>	N/A	N/A	1	3 <sup>④</sup>	13 <sup>⑤</sup>

① This table illustrates a typical memory configuration for a standard circuit monitor, with one data log storing the following data hourly: 3Ø avg. amps, volts (L-L, L-N), PF, kW, kVAR, freq., 3Ø demand for amps, kW, kVA, kWh, and kVARH.

② Waveform & event captures are stored in non-volatile memory in the CM-2350 and CM-2450. The exact number of waveforms and event captures that can be stored depends on how much memory is allocated to event & data logs.

③ The standard CM-2150, -2250, -2350, and -2450 can store up to 51,200 values (100K).

④ The CM-2350 and CM-2450 can store up to 20 waveform captures or 8 twelve-cycle event captures.

⑤ The standard CM-2452 can store over 180,000 values (356K), including up to 60 waveform captures, or 29 twelve-cycle event captures.

### HOW POWER FACTOR IS STORED

Each power factor value occupies one register. Power factor values are stored using signed magnitude notation (see figure 9-2). Bit number 16, the sign bit, indicates leading/lagging. A positive value (bit 16=0) always indicates leading. A negative value (bit 16=1) always indicates lagging. Bits 1–9 store a value in the range 0–1000 decimal. For example the circuit monitor would return a leading power factor of 0.5 as 500. Divide by 1000 to get a power factor in the range 0 to 1.000.

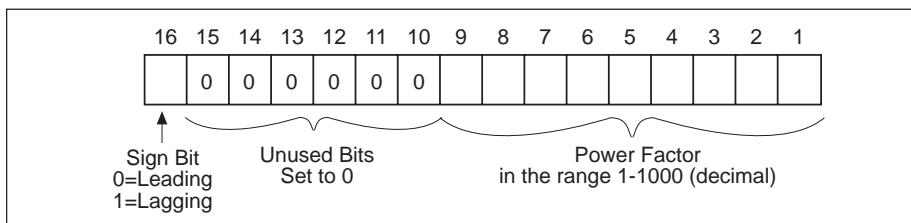

Figure 9-2: Power factor register format

When the power factor is lagging, the circuit monitor returns a high negative value—for example, -31,794. This happens because bit 16=1 (for example, the binary equivalent of -31,794 is 1000001111001110). To get a value in the range 0 to 1000, you need to mask bit 16. You do this by adding 32,768 to the value. An example will help clarify.

Assume that you read a power factor value of -31,794. Convert this to a power factor in the range 0 to 1.000, as follows:

$$-31,794 + 32,768 = 974$$

$$974/1000 = .974 \text{ lagging power factor}$$

### CHANGING THE VAR SIGN CONVENTION

The circuit monitor offers two VAR sign conventions. Figure 9-3 shows the default sign convention. Figure 9-4 shows the alternate sign convention. The procedures below tell how to change the sign convention using the command interface. For a description of the command interface and a complete listing of command codes, see **The Command Interface** in this chapter.

To change to the alternate sign convention, complete the following steps:

1. Write command code 4311 to register 7700.
  2. Write command code 1110 to register 7700.
- This resets the circuit monitor, causing it to use the new convention.

To return to the default sign convention, complete the following steps:

1. Write command code 4310 to register 7700.
  2. Write command code 1110 to register 7700.
- This resets the circuit monitor, causing it to return to the default sign convention.

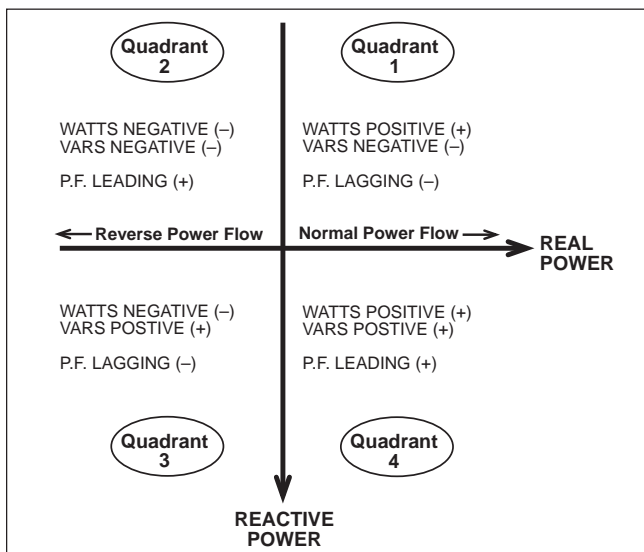

Figure 9-3: Default VAR sign convention

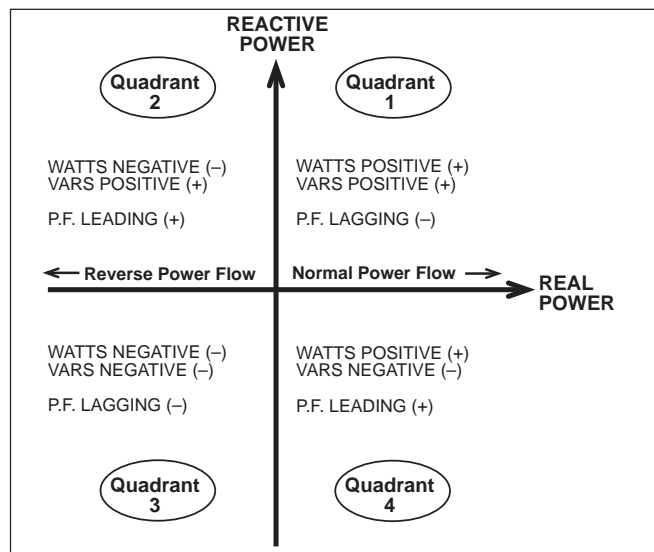

Figure 9-4: Optional VAR sign convention



**CONDITIONAL ENERGY**

Circuit monitor registers 1629–1648 are *conditional energy* registers. Conditional energy can be controlled in one of two ways:

- Over the communications link, by writing commands to the circuit monitor’s command interface
- OR
- By a status input—for example, conditional energy accumulates when the assigned status input is on, but does not accumulate when the status input is off.

The following procedures tell how to set up conditional energy for command interface control, and for status input control. The procedures refer to register numbers and command codes. For a listing of circuit monitor registers, see **Appendix B**. For a listing of command codes, see **The Command Interface** in this chapter.

**Command Interface Control** *To set control of conditional energy to the command interface:*

- Write command code 2341 to register 7700.  
To verify proper setup, read register 2081. Bit 6 should read 1, indicating command interface control. Bit 7 should read 0, indicating that condition energy accumulation is off.

*To start conditional energy accumulation:*

- Write command code 6321 to register 7700.  
While conditional energy is accumulating, bit 7 of register 2081 should read 1, indicating that conditional energy accumulation is on.

*To stop conditional energy accumulation:*

- Write command code 6320 to register 7700.

*To clear all conditional energy registers (1629-1648):*

1. Write command code 6220 to register 7700.

**Status Input Control**

*To configure conditional energy for status input control:*

1. Write command code 2340 to register 7700.
2. Specify the status input that will drive conditional energy accumulation by writing a bitmap to register 7701. Set the appropriate bit to 1 to indicate the desired input (input S1=bit 1, S2=bit 2, S3=bit 3, S4=bit 4).
3. Write command code 3390 to register 7700.  
To verify proper setup, read register 2081. Bit 6 should read 0, indicating that conditional energy accumulation is under status input control. Bit 7 should read 0 when the status input is off, indicating that conditional energy accumulation is off. Bit 7 should read 1 when the status input is on, indicating that conditional energy accumulation is on.

*To clear all conditional energy registers (1629–1648):*

- Write command code 6220 to register 7700.

## INCREMENTAL ENERGY

The circuit monitor's incremental energy feature allows you to define a start time and time interval for incremental energy accumulation. At the end of each incremental energy period, the following information is available:

- WH IN during the last completed interval (reg. 1649–1651)
- VARH IN during the last completed interval (reg. 1652–1654)
- WH OUT during the last completed interval (reg. 1655–1657)
- VARH OUT during the last completed interval (reg. 1658–1660)
- VAH during the last completed interval (reg. 1661–1663)
- Date/time of the last completed interval (reg. 1869–1871)
- Peak kW demand during the last completed interval (reg. 1749)
- Date/Time of Peak kW during the last interval (reg. 1878–1880)
- Peak kVAR demand during the last completed interval (reg. 1750)
- Date/Time of Peak kVAR during the last interval (reg. 1881–1883)
- Peak kVA demand during the last completed interval (reg. 1751)
- Date/Time of Peak kVA during the last interval (reg. 1884–1886)

The incremental energy data listed above can be logged by the circuit monitor. This logged data provides all the information needed to analyze energy and power usage against present or future utility rates. The information is especially useful for doing “what ifs” with time-of-use rate structures.

When using the incremental energy feature, keep the following points in mind:

- Peak demands help minimize the size of the data log in cases of sliding or rolling demand. Shorter incremental energy periods make it easier to reconstruct a load profile analysis.
- Since the incremental energy registers are synchronized to the circuit monitor clock, it is possible to log this data from multiple circuits and perform accurate totalization.

## Using Incremental Energy

Incremental energy accumulation begins at the specified start date and offset time. Once the start date has arrived, a new incremental energy period begins at the specified offset time.

Incremental energy calculations continue around the clock at the specified interval. However, a new incremental energy calculation will begin each new day at the offset time regardless of where it is in the present interval. For example:

Offset time = 8:00 a.m.  
Interval = 14 hours

The first incremental energy calculation will be from 8:00 a.m. to 10:00 p.m. (14 hours). The next interval will be from 10:00 p.m. to 8:00 a.m. the next day, even though that interval will only be 10 hours. This is because 8:00 a.m. is

your specified offset time. Incremental energy accumulation will then continue in this manner until the configuration is changed or a new interval is started by a remote master.

*To set up incremental energy:*

1. Write a start date and offset time to registers 1863–1865.
2. Write the desired interval length, from 0–1440 minutes, to register 2076. If incremental energy will be controlled from a remote master, such as a programmable controller, write a value of zero here.

*To start a new incremental energy interval from a remote master:*

- Write command code 6910 to register 7700.

## CHANGING THE DEMAND CALCULATION METHOD

The circuit monitor can be configured to use one of three demand power calculation methods:

- thermal demand (circuit monitor default)
- external pulse synchronized demand
- block interval demand with rolling subinterval (block/rolling)

For a description of the demand power calculation methods, see **Demand Power Calculation Methods** in **Chapter 2**.

The thermal demand method is the default. To set up the circuit monitor for thermal demand, simply define the demand interval. See **Setting the Demand Interval** in **Chapter 4** of the *Circuit Monitor Installation and Operation Bulletin* for instructions.

### Changing to the Block/Rolling Method

To change to the block/rolling demand method, the user must write to the command interface over the communications link. (For a description of the command interface and a list of command codes, see **The Command Interface** in this chapter.)

*To change to the block/rolling method, complete the following steps:*

1. Write command code 5311 to register 7700.
2. Write command code 1110 to command interface register 7700. This resets the circuit monitor, causing it to recognize the new demand calculation method.
3. Write a subinterval value in minutes into register 2078. If the subinterval is set equal to the demand interval, the demand calculation will update once each demand interval (block mode). If the subinterval equals zero, the demand calculation will update every 15 seconds (sliding window).

## **SETTING UP A DEMAND SYNCH PULSE INPUT**

The external pulse synchronized demand method allows a circuit monitor, equipped with an I/O module, to accept a demand synch pulse from another demand meter. When this method is used, the circuit monitor watches input S1 for a pulse that signals the start of a new demand interval. This allows the circuit monitor's demand interval "window" to match the other meter's demand interval "window." For a detailed description of this feature, see **Demand Synch Pulse Input** in **Chapter 3**.

*To set up the circuit monitor to accept a demand synch pulse input:*

- Set the demand interval to 0 from the circuit monitor front panel. See **Setting the Demand Interval** in **Chapter 4** of the *Circuit Monitor Installation and Operation Bulletin* for instructions on setting the demand interval using the circuit monitor's front panel.

OR

1. Using application software, write a value of zero to register 2077, the demand interval configuration register.
2. Using application software, write command code 5311 to register 7700 to select block demand mode.
3. Using application software, write command code 5320 to register 7700 to set the external synch source to S1.

## **CONTROLLING THE DEMAND INTERVAL OVER THE COMMUNICATIONS LINK**

The circuit monitor's demand interval can be controlled over the communications link. For example, a programmable controller can signal the start of each new demand interval.

The circuit monitor's command interface is used to control the demand interval over the communications link. For a description of the command interface and a list of command codes, see **The Command Interface** in this chapter.

*To set demand control to the command interface:*

1. Using application software, write a value of zero to register 2077, the demand interval configuration register.
2. Using application software, write command code 5311 to register 7700 to select block demand mode.
3. Using application software, write command code 5321 to register 7700.

*To start a new demand interval:*

- Write command code 5910 to register 7700.

**SETTING UP INDIVIDUAL HARMONIC CALCULATIONS**

Circuit monitor models 2350 and higher can perform harmonic magnitude and angle calculations for each metered input. The harmonic magnitude can be formatted as either a percentage of the fundamental or as a percentage of the rms values. The harmonic magnitude and angles are stored in a set of registers: 4002–4447. The circuit monitor updates the values in these registers over a 10-metering update cycle period. During the time that the circuit monitor is refreshing harmonic data, the circuit monitor posts a value of 0 in register 2037. When the whole set of harmonic registers is updated with new data, the circuit monitor posts a value of 1 in register 2037. The circuit monitor can be configured to hold the values in these registers for up to 60 metering update cycles once the data processing is complete.

There are three operating modes for harmonic data processing: disabled, voltage only, and voltage and current. Because of the extra processing time necessary to perform these calculations, the factory default operating mode is disabled.

Write to the following registers to configure the harmonic data processing:

Reg. No.	Value	Description
2033	1–60	Number of metering update cycles between harmonic data updates
2034	0, 1	Harmonic magnitude formatting; 0=% of fundamental (default) 1=% of rms
2035	0, 1, 2	Harmonic processing; 0=disabled 1=voltage harmonics only enabled 2=voltage and current harmonics enabled

Register 2037 indicates whether harmonic data processing is complete.

2037	0, 1	0=processing incomplete 1=processing complete
------	------	--

Register 2036 shows the number of metering update cycles remaining before the next harmonic data update begins.

2036	0–60	Number of metering update cycles remaining before the next update.
------	------	--

## **STATUS INPUT PULSE DEMAND METERING**

When equipped with an I/O module, the circuit monitor can count pulses from an external source, such as a watt-hour meter equipped with a pulse initiator. This allows the circuit monitor to keep track of demand information by counting pulses.

The circuit monitor provides ten input pulse demand channels (see figure 9-5). Each channel maintains pulse count data taken from one or more status inputs assigned to that channel. For each channel, the circuit monitor maintains the following information:

- Present Interval Pulse Count—the number of pulses counted so far during the present interval.
- Last Completed Interval Pulse Count—the number of pulses counted during the last completed interval.
- Peak Interval Pulse Count—the maximum number of pulses counted during a completed interval since the last power demand reset.
- Date/Time of Peak—the date and time of the peak interval pulse count (described above) since the last power demand reset.

For each channel, utility registers are provided which can be defined by custom application software as storage locations for:

- Units—for example, kWh, kVARh, or kVAh.
- Weight factor—a weight factor for each pulse. For example, you might define that each pulse is equal to 10.0 kW.
- Scale Code—a scale factor to indicate what power of 10 to apply to the weight factor

The pulse demand interval can be chosen to synchronize all channels with the power demand interval (block only), the incremental energy interval, a status input transition, or by external communications.

### **Pulse Counting Example**

Figure 9-5, page 79, shows how you might apply the pulse demand metering feature. In the example, channels 1, 2 have been assigned to count pulses from inputs S1 and S2, respectively. Channel 10 has been assigned inputs S1 and S2. Therefore, channel 10 will totalize the pulses from S1 and S2.

Refer to **Appendix B—Abbreviated Register Listing**, for information on registers 2898–2999.

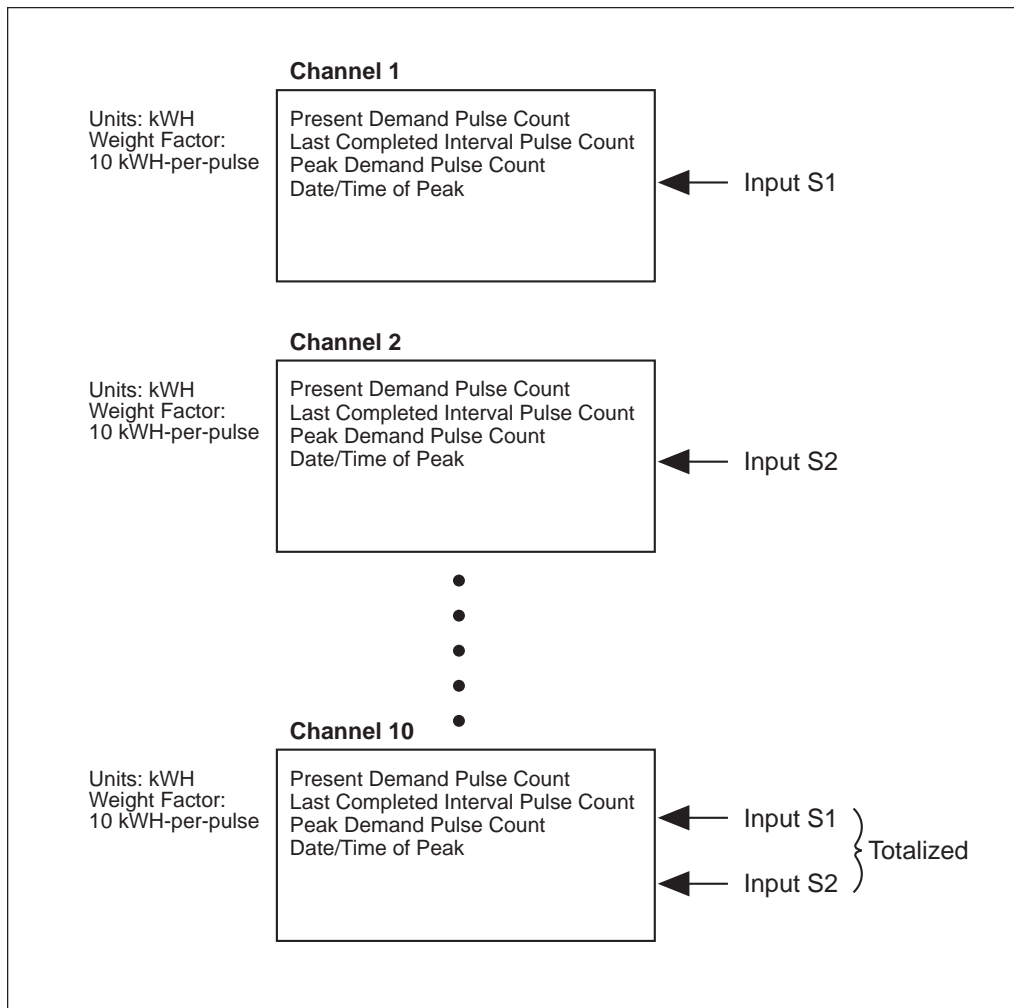

Figure 9-5: Pulse demand metering example





**APPENDIX A—COMMUNICATION CABLE PINOUTS**

**CAB-107**

Circuit Monitor Terminal	Male DB-9 Connector
IN- (21)—White	1
IN+ (20)—Green	2
OUT- (23)—Black	3
OUT+ (22)—Red	4
	5
	6
	7
	8
SHLD (24) Shield	9

**CAB-108**

TXA—White	1
TXB—Green	2
RXA—Black	3
RXB—Red	4
	5
	6
	7
	8
Shield—Shield	9

**CC-100**

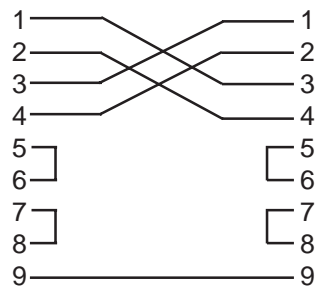

**CAB-102, CAB-104**

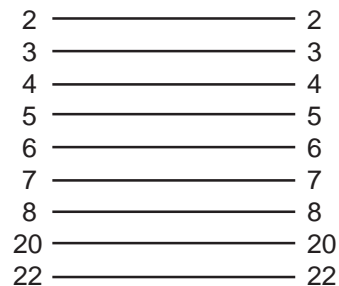



## APPENDIX B—ABBREVIATED REGISTER LISTING

This appendix contains an abbreviated listing of circuit monitor registers. The following values are included in this register listing:

- Real-Time Metered Values
- Real-Time Meter Values Minimum
- Real-Time Meter Values Maximum
- Energy Values
- Demand Values
- Dates and Times
- Status Inputs
- Relay Outputs
- Circuit Monitor Configuration Values

In this appendix, the following information is provided for each register:

- Register Number (see note below)
- Register Description
- Units
- Range

*Note: Some registers in this section apply only to circuit monitors with firmware version 17.009 or higher. To determine a circuit monitor's firmware version from the front panel, see **Viewing Configuration Data In Protected Mode** in **Chapter 4** of the *Circuit Monitor Installation and Operation Bulletin*. Step 3 tells how to determine the firmware version.*

*To determine the firmware version over comms, follow these steps:*

1. *Read register 2094. The two digits on the left in the 4-digit decimal value represent the reset code revision; the two digits on the right represent the circuit monitor firmware version.*
2. *Read register 2093. The decimal value represents the circuit monitor firmware sub-revision level, as in firmware version 16.001.*

<u>Reg. No.</u>	<u>Description</u>	<u>Units</u>	<u>Range</u>
1000	Update Interval	In 1000ths of a second	0 to 10,000
1001	Frequency	Hertz/Scale Factor F	2300 to 6700 (50/60) 3500 to 4500 (400)
1002	Temperature inside CM enclosure	Degrees C in 100ths	-10,000 to +10,000
1003	Current, Phase A	Amps/Scale Factor A	0 to 32,767
1004	Current, Phase B	Amps/Scale Factor A	0 to 32,767
1005	Current, Phase C	Amps/Scale Factor A	0 to 32,767
1006	Current, Neutral	Amps/Scale Factor B	0 to 32,767
1007	Current, Ground	Amps/Scale Factor C	0 to 32,767
1008	Current, 3-Phase Average	Amps/Scale Factor A	0 to 32,767
1009	Current, Apparent rms	Amps/Scale Factor A	0 to 32,767
1010	Current Unbalance, Phase A	Percent in 10ths	0 to ±1000
1011	Current Unbalance, Phase B	Percent in 10ths	0 to ±1000
1012	Current Unbalance, Phase C	Percent in 10ths	0 to ±1000
1013	Current Unbalance, Worst	Percent in 10ths	0 to ±1000
1014	Voltage, Phase A to B	Volts/Scale Factor D	0 to 32,767
1015	Voltage, Phase B to C	Volts/Scale Factor D	0 to 32,767
1016	Voltage, Phase C to A	Volts/Scale Factor D	0 to 32,767
1017	Voltage L-L, 3-Phase Average	Volts/Scale Factor D	0 to 32,767
1018	Voltage, Phase A to Neutral	Volts/Scale Factor D	0 to 32,767
1019	Voltage, Phase B to Neutral	Volts/Scale Factor D	0 to 32,767
1020	Voltage, Phase C to Neutral	Volts/Scale Factor D	0 to 32,767
1021	Voltage L-N, 3-Phase Average	Volts/Scale Factor D	0 to 32,767
1022	Voltage Unbalance, Phase A-B	Percent in 10ths	0 to ±1000
1023	Voltage Unbalance, Phase B-C	Percent in 10ths	0 to ±1000
1024	Voltage Unbalance, Phase C-A	Percent in 10ths	0 to ±1000
1025	Voltage Unbalance, L-L Worst	Percent in 10ths	0 to ±1000
1026	Voltage Unbalance, Phase A	Percent in 10ths	0 to ±1000
1027	Voltage Unbalance, Phase B	Percent in 10ths	0 to ±1000
1028	Voltage Unbalance, Phase C	Percent in 10ths	0 to ±1000
1029	Voltage Unbalance, L-N Worst	Percent in 10ths	0 to ±1000
1031	True Power Factor, Phase A	In 1000ths	-100 to +1000 to +100 <sup>①</sup>
1032	True Power Factor, Phase B	In 1000ths	-100 to +1000 to +100 <sup>①</sup>
1033	True Power Factor, Phase C	In 1000ths	-100 to +1000 to +100 <sup>①</sup>
1034	True Power Factor, 3-Phase Total	In 1000ths	-100 to +1000 to +100 <sup>①</sup>
1035	Displacement Power Factor, Phase A	In 1000ths	-100 to +1000 to +100 <sup>①</sup>
1036	Displacement Power Factor, Phase B	In 1000ths	-100 to +1000 to +100 <sup>①</sup>
1037	Displacement Power Factor, Phase C	In 1000ths	-100 to +1000 to +100 <sup>①</sup>
1038	Displacement Power Factor, 3-Phase Total	In 1000ths	-100 to +1000 to +100 <sup>①</sup>
1039	Real Power, Phase A	kW/Scale Factor E	0 to ±32,767
1040	Real Power, Phase B	kW/Scale Factor E	0 to ±32,767
1041	Real Power, Phase C	kW/Scale Factor E	0 to ±32,767
1042	Real Power, 3-Phase Total	kW/Scale Factor E	0 to ±32,767
1043	Reactive Power, Phase A	kVAr/Scale Factor E	0 to ±32,767
1044	Reactive Power, Phase B	kVAr/Scale Factor E	0 to ±32,767
1045	Reactive Power, Phase C	kVAr/Scale Factor E	0 to ±32,767
1046	Reactive Power, 3-Phase Total	kVAr/Scale Factor E	0 to ±32,767
1047	Apparent Power, Phase A	kVA/Scale Factor E	0 to +32,767
1048	Apparent Power, Phase B	kVA/Scale Factor E	0 to +32,767
1049	Apparent Power, Phase C	kVA/Scale Factor E	0 to +32,767
1050	Apparent Power, 3-Phase Total	kVA/Scale Factor E	0 to +32,767

① See **How Power Factor is Stored** in Chapter 13 for a description of the power factor register format.

<u>Reg. No.</u>	<u>Description</u>	<u>Units</u>	<u>Range</u>
1051	THD Phase A Current	% in 10ths	0 to 32,767
1052	THD Phase B Current	% in 10ths	0 to 32,767
1053	THD Phase C Current	% in 10ths	0 to 32,767
1054	THD Phase Neutral Current	% in 10ths	0 to 32,767
1055	THD Phase A Voltage	% in 10ths	0 to 32,767
1056	THD Phase B Voltage	% in 10ths	0 to 32,767
1057	THD Phase C Voltage	% in 10ths	0 to 32,767
1058	THD Phase A-B Voltage	% in 10ths	0 to 32,767
1059	THD Phase B-C Voltage	% in 10ths	0 to 32,767
1060	THD Phase C-A Voltage	% in 10ths	0 to 32,767
1061	thd Phase A Current	% in 10ths	0 to 32,767
1062	thd Phase B Current	% in 10ths	0 to 32,767
1063	thd Phase C Current	% in 10ths	0 to 32,767
1064	thd Phase Neutral Current	% in 10ths	0 to 32,767
1065	thd Phase A Voltage	% in 10ths	0 to 32,767
1066	thd Phase B Voltage	% in 10ths	0 to 32,767
1067	thd Phase C Voltage	% in 10ths	0 to 32,767
1068	thd Phase A-B Voltage	% in 10ths	0 to 32,767
1069	thd Phase B-C Voltage	% in 10ths	0 to 32,767
1070	thd Phase C-A Voltage	% in 10ths	0 to 32,767
1071	K-Factor, Phase A	In 10ths	0 to 10,000
1072	K-Factor, Phase B	In 10ths	0 to 10,000
1073	K-Factor, Phase C	In 10ths	0 to 10,000
1074	Crest Factor, Phase A	In 100ths	0 to 10,000
1075	Crest Factor, Phase B	In 100ths	0 to 10,000
1076	Crest Factor, Phase C	In 100ths	0 to 10,000
1077	Crest Factor, Neutral	In 100ths	0 to 10,000
1078	Phase A Current, Fundamental rms Magnitude	Amps/Scale Factor A	0 to 32,767
1079	Phase A Current, Fundamental Coincident Angle	In 10ths of degrees	0 to 3,599
1080	Phase B Current, Fundamental rms Magnitude	Amps/Scale Factor A	0 to 32,767
1081	Phase B Current, Fundamental Coincident Angle	In 10ths of degrees	0 to 3,599
1082	Phase C Current, Fundamental rms Magnitude	Amps/Scale Factor A	0 to 32,767
1083	Phase C Current, Fundamental Coincident Angle	In 10ths of degrees	0 to 3,599
1084	Neutral Current, Fundamental rms Magnitude	Amps/Scale Factor B	0 to 32,767
1085	Neutral Current, Fundamental Coincident Angle	In 10ths of degrees	0 to 3,599
1086	Ground Current, Fundamental rms Magnitude	Amps/Scale Factor C	0 to 32,767
1087	Ground Current, Fundamental Coincident Angle	In 10ths of degrees	0 to 3,599
1088	Phase A Voltage, Fundamental rms Magnitude	Volts/Scale Factor D	0 to 32,767
1089	Phase A Voltage, Fundamental Coincident Angle	In 10ths of degrees	0 to 3,599
1090	Phase B Voltage, Fundamental rms Magnitude	Volts/Scale Factor D	0 to 32,767
1091	Phase B Voltage, Fundamental Coincident Angle	In 10ths of degrees	0 to 3,599
1092	Phase C Voltage, Fundamental rms Magnitude	Volts/Scale Factor D	0 to 32,767
1093	Phase C Voltage, Fundamental Coincident Angle	In 10ths of degrees	0 to 3,599
1094	Phase A-B Voltage, Fundamental rms Magnitude	Volts/Scale Factor D	0 to 32,767
1095	Phase A-B Voltage, Fundamental Coincident Angle	In 10ths of degrees	0 to 3,599
1096	Phase B-C Voltage, Fundamental rms Magnitude	Volts/Scale Factor D	0 to 32,767
1097	Phase B-C Voltage, Fundamental Coincident Angle	In 10ths of degrees	0 to 3,599
1098	Phase C-A Voltage, Fundamental rms Magnitude	Volts/Scale Factor D	0 to 32,767
1099	Phase C-A Voltage, Fundamental Coincident Angle	In 10ths of degrees	0 to 3,599
1100	Phase A Fundamental Real Power	KW/Scale Factor E	0 to ±32,767
1101	Phase B Fundamental Real Power	KW/Scale Factor E	0 to ±32,767

<u>Reg. No.</u>	<u>Description</u>	<u>Units</u>	<u>Range</u>
1102	Phase C Fundamental Real Power	KW/Scale Factor E	0 to ±32,767
1103	3-Phase Total Fundamental Real Power	KW/Scale Factor E	0 to ±32,767
1104	Phase A Fundamental Reactive Power	KW/Scale Factor E	0 to ±32,767
1105	Phase B Fundamental Reactive Power	KW/Scale Factor E	0 to ±32,767
1106	Phase C Fundamental Reactive Power	KW/Scale Factor E	0 to ±32,767
1107	3-Phase Total Fundamental Reactive Power	KW/Scale Factor E	0 to ±32,767
1108	Harmonic Factor, Phase A	% in 10ths	0 to 1000
1109	Harmonic Factor, Phase B	% in 10ths	0 to 1000
1110	Harmonic Factor, Phase C	% in 10ths	0 to 1000
1111	Harmonic Factor, 3-Phase Total	% in 10ths	0 to 1000
1112	Harmonic Power, Phase A	KW/Scale Factor E	0 to ±32,767
1113	Harmonic Power, Phase B	KW/Scale Factor E	0 to ±32,767
1114	Harmonic Power, Phase C	KW/Scale Factor E	0 to ±32,767
1115	Harmonic Power, 3-Phase Total	KW/Scale Factor E	0 to ±32,767
1117	Phase Rotation: 0=Normal A-B-C, 1=C-B-A	none	0 to 1

**ANALOG INPUT PRESENT VALUE REGISTERS**

1191	Analog Input 1 Present Value	None	-32767 to +32767	The present scaled value of analog input 1.
1192	Analog Input 2 Present Value	None	-32767 to +32767	The present scaled value of analog input 2.
1193	Analog Input 3 Present Value	None	-32767 to +32767	The present scaled value of analog input 3.
1194	Analog Input 4 Present Value	None	-32767 to +32767	The present scaled value of analog input 4.

**REAL TIME METERED VALUES MINIMUM**

1200	Minimum Update Interval		In 1000ths of a second	0 to 10,000
1201	Minimum Freq.		Hertz/Scale Factor F	2300 to 6700, (50/60) 3500 to 4500 (400)
1202	Minimum Temp.		Degrees Cent.	±10,000 in 100ths
1203	Minimum Current Phase A		Amps/Scale Factor A	0 to 32,767
1204	Minimum Current Phase B		Amps/Scale Factor A	0 to 32,767
1205	Minimum Current Phase C		Amps/Scale Factor A	0 to 32,767
1206	Minimum Current Neutral (I4)		Amps/Scale Factor A	0 to 32,767
1207	Minimum Current Ground (I5)		Amps/Scale Factor A	0 to 32,767
1208	Minimum Current 3-Phase Average		Amps/Scale Factor A	0 to 32,767
1209	Minimum Current Apparent rms		Amps/Scale Factor A	0 to 32,767
1210	Minimum Current Unbalance, Phase A		Percent in 10ths	0 to ±1000
1211	Minimum Current Unbalance, Phase B		Percent in 10ths	0 to ±1000
1212	Minimum Current Unbalance, Phase C		Percent in 10ths	0 to ±1000
1213	Minimum Current Unbalance Worst		Percent in 10ths	0 to ±1000
1214	Minimum Volt. Phase A to B		Volts/Scale Factor D	0 to 32,767
1215	Minimum Volt. Phase B to C		Volts/Scale Factor D	0 to 32,767
1216	Minimum Volt. Phase C to A		Volts/Scale Factor D	0 to 32,767
1217	Minimum Volt L-L, 3-Phase Average		Volts/Scale Factor D	0 to 32,767
1218	Minimum Volt. Phase A to Neutral		Volts/Scale Factor D	0 to 32,767
1219	Minimum Volt. Phase B to Neutral		Volts/Scale Factor D	0 to 32,767
1220	Minimum Volt. Phase C to Neutral		Volts/Scale Factor D	0 to 32,767
1221	Minimum Volt L-N, 3-Phase Average		Volts/Scale Factor D	0 to 32,767

<u>Reg. No.</u>	<u>Description</u>	<u>Units</u>	<u>Range</u>
1222	Minimum Volt Unbalance Phase A-B	Percent in 10ths	0 to ±1000
1223	Minimum Volt Unbalance Phase B-C	Percent in 10ths	0 to ±1000
1224	Minimum Volt Unbalance Phase C-A	Percent in 10ths	0 to ±1000
1225	Minimum Volt Unbalance L-L Worst	Percent in 10ths	0 to ±1000
1226	Minimum Volt Unbalance Phase A	Percent in 10ths	0 to ±1000
1227	Minimum Volt Unbalance Phase B	Percent in 10ths	0 to ±1000
1228	Minimum Volt Unbalance Phase C	Percent in 10ths	0 to ±1000
1229	Minimum Volt L-N Unbalance Worst	Percent in 10ths	0 to ±1000
1231	Minimum True, Power Factor A	In 1000ths	-100 to +1000 to +100
1232	Minimum True, Power Factor B	In 1000ths	-100 to +1000 to +100
1233	Minimum True, Power Factor C	In 1000ths	-100 to +1000 to +100
1234	Minimum True, Power Factor, 3 Total	In 1000ths	-100 to +1000 to +100
1235	Minimum Displ. Power Factor, A	In 1000ths	-100 to +1000 to +100
1236	Minimum Displ. Power Factor, B	In 1000ths	-100 to +1000 to +100
1237	Minimum Displ. Power Factor, C	In 1000ths	-100 to +1000 to +100
1238	Minimum Displ. Power Factor, 3-phase Total	In 1000ths	-100 to +1000 to +100
1239	Minimum Real Power, Phase A	kW/Scale Factor E	0 to ±32,767
1240	Minimum Real Power, Phase B	kW/Scale Factor E	0 to ±32,767
1241	Minimum Real Power, Phase C	kW/Scale Factor E	0 to ±32,767
1242	Minimum Real Power 3-Phase Total	kW/Scale Factor E	0 to ±32,767
1243	Minimum Reactive Power Phase A	kVAr/Scale Factor E	0 to ±32,767
1244	Minimum Reactive Power Phase B	kVAr/Scale Factor E	0 to ±32,767
1245	Minimum Reactive Power Phase C	kVAr/Scale Factor E	0 to ±32,767
1246	Minimum Reactive Power 3-Phase Total	kVAr/Scale Factor E	0 to ±32,767
1247	Minimum Apparent Power Phase A	kVA/Scale Factor E	0 to +32,767
1248	Minimum Apparent Power Phase B	kVA/Scale Factor E	0 to +32,767
1249	Minimum Apparent Power Phase C	kVA/Scale Factor E	0 to +32,767
1250	Minimum Apparent Power 3-Phase Total	kVA/Scale Factor E	0 to +32,767
1251	Minimum THD Phase A Current	% in 10ths	0 to 32,767
1252	Minimum THD Phase B Current	% in 10ths	0 to 32,767
1253	Minimum THD Phase C Current	% in 10ths	0 to 32,767
1254	Minimum THD Neutral Current	% in 10ths	0 to 32,767
1255	Minimum THD Phase A Voltage	% in 10ths	0 to 32,767
1256	Minimum THD Phase B Voltage	% in 10ths	0 to 32,767
1257	Minimum THD Phase C Voltage	% in 10ths	0 to 32,767
1258	Minimum THD A-B Voltage	% in 10ths	0 to 32,767
1259	Minimum THD B-C Voltage	% in 10ths	0 to 32,767
1260	Minimum THD C-A Voltage	% in 10ths	0 to 32,767
1271	Minimum K-Factor A	In 10ths	0 to 10,000
1272	Minimum K-Factor B	In 10ths	0 to 10,000
1273	Minimum K-Factor C	In 10ths	0 to 10,000

**ANALOG INPUT MIN REGISTERS**

1391	Analog Input 1 Minimum Value	None	-32767 to +32767	The minimum scaled value of analog input 1 since the last reset of min/max values.
1392	Analog Input 2 Minimum Value	None	-32767 to +32767	The minimum scaled value of analog input 2 since the last reset of min/max values.
1393	Analog Input 3 Minimum Value	None	-32767 to +32767	The minimum scaled value of analog input 3 since the last reset of min/max values.
1394	Analog Input 4 Minimum Value	None	-32767 to +32767	The minimum scaled value of analog input 4 since the last reset of min/max values.

<u>Reg. No.</u>	<u>Description</u>	<u>Units</u>	<u>Range</u>
<b>REAL TIME METERED VALUES MAXIMUM</b>			
1400	Maximum Update Interval	In 1000ths of a second	0 to 10,000
1401	Maximum Freq.	Hertz/Scale Factor F	2300 to 6700, (50/60) 3500 to 4500 (400)
1402	Maximum Temp.	Degrees Cent. in 100ths	-10,000 to +10,000
1403	Maximum Current Phase A	Amps/Scale Factor A	0 to 32,767
1404	Maximum Current Phase B	Amps/Scale Factor A	0 to 32,767
1405	Maximum Current Phase C	Amps/Scale Factor A	0 to 32,767
1406	Maximum Current Neutral (I4)	Amps/Scale Factor B	0 to 32,767
1407	Maximum Current Ground (I5)	Amps/Scale Factor C	0 to 32,767
1408	Maximum Current 3-Phase Average	Amps/Scale Factor A	0 to 32,767
1409	Maximum Current, Apparent rms	Amps/Scale Factor A	0 to 32,767
1410	Maximum Current Unbalance, Phase A	Percent in 10ths	0 to ±1000
1411	Maximum Current Unbalance, Phase B	Percent in 10ths	0 to ±1000
1412	Maximum Current Unbalance, Phase C	Percent in 10ths	0 to ±1000
1413	Maximum Current Unbalance Worst	Percent in 10ths	0 to ±1000
1414	Maximum Voltage Phase A to B	Volts/Scale Factor D	0 to 32,767
1415	Maximum Voltage Phase B to C	Volts/Scale Factor D	0 to 32,767
1416	Maximum Voltage Phase C to A	Volts/Scale Factor D	0 to 32,767
1417	Maximum Volt L-L, 3-Phase Average	Volts/Scale Factor D	0 to 32,767
1418	Maximum Voltage Phase A to Neutral	Volts/Scale Factor D	0 to 32,767
1419	Maximum Voltage Phase B to Neutral	Volts/Scale Factor D	0 to 32,767
1420	Maximum Voltage Phase C to Neutral	Volts/Scale Factor D	0 to 32,767
1421	Maximum Volt L-N, 3-Phase Average	Volts/Scale Factor D	0 to 32,767
1422	Maximum Volt Unbalance Phase A-B	Percent in 10ths	0 to ±1000
1423	Maximum Volt Unbalance Phase B-C	Percent in 10ths	0 to ±1000
1424	Maximum Volt Unbal. Phase C-A	Percent in 10ths	0 to ±1000
1425	Maximum Volt Unbal. L-L Worst	Percent in 10ths	0 to ±1000
1426	Maximum Volt Unbal. Phase A	Percent in 10ths	0 to ±1000
1427	Maximum Volt Unbal. Phase B	Percent in 10ths	0 to ±1000
1428	Maximum Volt Unbal. Phase C	Percent in 10ths	0 to ±1000
1429	Maximum Volt L-N. Unbal. Worst	Percent in 10ths	0 to ±1000
1431	Maximum True, Power Factor A	in 1000ths	-100 to +1000 to +100
1432	Maximum True, Power Factor B	In 1000ths	-100 to +1000 to +100
1433	Maximum True, Power Factor C	In 1000ths	-100 to +1000 to +100
1434	Maximum True, Power Factor 3-Phase Total	In 1000ths	-100 to +1000 to +100
1435	Maximum Displ. Power Factor Phase A	In 1000ths	-100 to +1000 to +100
1436	Maximum Displ. Power Factor, Phase B	In 1000ths	-100 to +1000 to +100
1437	Maximum Displ. Power Factor Phase C	In 1000ths	-100 to +1000 to +100
1438	Maximum Displ. Power Factor 3-Phase Total	Percent	-100 to +1000 to +100
1439	Maximum Real Power Phase A	kW/Scale Factor E	0 to ±32,767
1440	Maximum Real Power Phase B	kW/Scale Factor E	0 to ±32,767
1441	Maximum Real Power Phase C	kW/Scale Factor E	0 to ±32,767
1442	Maximum Real Power 3 Total	kW/Scale Factor E	0 to ±32,767
1443	Maximum Reactive Power Phase A	kVAr/Scale Factor E	0 to ±32,767
1444	Maximum Reactive Power Phase B	kVAr/Scale Factor E	0 to ±32,767
1445	Maximum Reactive Power Phase C	kVAr/Scale Factor E	0 to ±32,767
1446	Maximum Reactive Power 3-Phase Total	kVAr/Scale Factor E	0 to ±32,767
1447	Maximum Apparent Power Phase A	kVA/Scale Factor E	0 to +32,767
1448	Maximum Apparent Power Phase B	kVA/Scale Factor E	0 to +32,767
1449	Maximum Apparent Power Phase C	kVA/Scale Factor E	0 to +32,767
1450	Maximum Apparent Power 3-Phase Total	kVA/Scale Factor E	0 to +32,767
1451	Maximum THD Phase A Current	% in 10ths	0 to 32,767
1452	Maximum THD Phase B Current	% in 10ths	0 to 32,767



<u>Reg. No.</u>	<u>Description</u>	<u>Units</u>	<u>Range</u>
1453	Maximum THD Phase C Current	% in 10ths	0 to 32,767
1454	Maximum THD Neutral Current	% in 10ths	0 to 10,000
1455	Maximum THD Phase A Voltage	% in 10ths	0 to 32,767
1456	Maximum THD Phase B Voltage	% in 10ths	0 to 32,767
1457	Maximum THD Phase C Voltage	% in 10ths	0 to 32,767
1458	Maximum THD A-B Voltage	% in 10ths	0 to 32,767
1459	Maximum THD B-C Voltage	% in 10ths	0 to 32,767
1460	Maximum THD C-A Voltage	% in 10ths	0 to 32,767
1471	Maximum K-Factor Phase A	In 10ths	0 to 10,000
1472	Maximum K-Factor Phase B	In 10ths	0 to 10,000
1473	Maximum K-Factor Phase C	In 10ths	0 to 10,000

**ANALOG INPUT MAX REGISTER**

1591	Analog Input 1 Maximum Value	None	-32767 to +32767	The maximum scaled value of analog input 1 since the last reset of min/max values.
1592	Analog Input 2 Maximum Value	None	-32767 to +32767	The maximum scaled value of analog input 2 since the last reset of min/max values.
1593	Analog Input 3 Maximum Value	None	-32767 to +32767	The maximum scaled value of analog input 3 since the last reset of min/max values.
1594	Analog Input 4 Maximum Value	None	-32767 to +32767	The maximum scaled value of analog input 4 since the last reset of min/max values.

**ENERGY VALUES**

Each energy is kept in 4 registers, except Incremental, which is kept in 3 registers; modulo 10,000 per register

**ACCUMULATED ENERGY**

1601–1604	Real Energy In 3-Phase Total	WH	0 to 9,999,999,999,999,999
1605–1608	Reactive Energy In 3-Phase Total	VArH	0 to 9,999,999,999,999,999
1609–1612	Real Energy Out 3-Phase Total	WH	0 to 9,999,999,999,999,999
1613–1616	Reactive Energy Out 3-Phase Total	VArH	0 to 9,999,999,999,999,999
1617–1620	Apparent Energy, 3-Phase Total	VAH	0 to 9,999,999,999,999,999
1621–1624	Real Energy Signed/Absolute 3-Phase Total	WH	0 to ±9,999,999,999,999,999
1625–1628	Reactive Energy Signed/Absolute 3-Phase Total	VArH	0 to ±9,999,999,999,999,999

**CONDITIONAL ACCUMULATED ENERGY**

1629–1632	Conditional Real Energy In, 3-Phase Total	WH	0 to 9,999,999,999,999,999
1633–1636	Conditional Reactive Energy In 3-Phase Total	VArH	0 to 9,999,999,999,999,999
1637–1640	Conditional Real Energy Out, 3-Phase Total	WH	0 to 9,999,999,999,999,999
1641–1644	Conditional Reactive Energy Out 3-Phase Total	VArH	0 to 9,999,999,999,999,999
1645–1648	Conditional Apparent Energy 3-Phase Total	VAH	0 to 9,999,999,999,999,999

**INCREMENTAL ACCUMULATED ENERGY**

1649–1651	Incremental Real Energy In, 3-Phase Total	WH	0 to 999,999,999,999
1652–1654	Incremental Reactive Energy In 3-Phase Total	VArH	0 to 999,999,999,999
1655–1657	Incremental Real Energy Out, 3-Phase Total	WH	0 to 999,999,999,999
1658–1660	Incremental Reactive Energy Out 3-Phase Total	VArH	0 to 999,999,999,999
1661–1663	Incremental Apparent Energy 3-Phase Total	VAH	0 to 999,999,999,999

<u>Reg. No.</u>	<u>Description</u>	<u>Units</u>	<u>Range</u>
<b>DEMAND VALUES</b>			
<b>CURRENT DEMAND</b>			
1700	Present Current Demand 3-Phase Average	Amps/Scale Factor A	0 to 32,767
1701	Present Current Demand Phase A	Amps/Scale Factor A	0 to 32,767
1702	Present Current Demand Phase B	Amps/Scale Factor A	0 to 32,767
1703	Present Current Demand Phase C	Amps/Scale Factor A	0 to 32,767
1704	Present Current Demand Neutral	Amps/Scale Factor A	0 to 32,767
1705	Thermal K-Factor Demand, Phase A	In 10ths	0 to 10,000
1706	Thermal K-Factor Demand, Phase B	In 10ths	0 to 10,000
1707	Thermal K-Factor Demand, Phase C	In 10ths	0 to 10,000
1708	Peak Current Demand 3-Phase Average	Amps/Scale Factor A	0 to 32,767
1709	Peak Current Demand Phase A	Amps/Scale Factor A	0 to 32,767
1710	Peak Current Demand Phase B	Amps/Scale Factor A	0 to 32,767
1711	Peak Current Demand Phase C	Amps/Scale Factor A	0 to 32,767
1712	Peak Current Demand Neutral	Amps/Scale Factor A	0 to 32,767
1713	K-Factor Demand Phase A Coincident Peak Product	In 10ths	0 to 10,000
1714	Current Demand Phase A Coincident Peak Product	Amps/Scale Factor A	0 to 32,767
1715	K-Factor Demand Phase B Coincident Peak Product	In 10ths	0 to 10,000
1716	Current Demand Phase B Coincident Peak Product	Amps/Scale Factor A	0 to 32,767
1717	K-Factor Demand Phase C Coincident Peak Product	In 10ths	0 to 10,000
1718	Current Demand Phase C Coincident Peak Product	Amps/Scale Factor A	0 to 32,767
<b>POWER DEMAND</b>			
Reactive Demand may be calculated using either the fundamental only (default), or total harmonics (user selectable).			
1730	Average Power Factor Over Interval	In 1000ths	-100 to 1000 to +100
1731	Present Real Power, Demand, 3-Phase Total	kW/Scale Factor E	0 to ±32,767
1732	Present Reactive Power, Demand, 3 Phase Total	kVAr/Scale Factor E	0 to ±32,767
1733	Present Apparent Power Demand 3-Phase Total	kVA/Scale Factor E	0 to 32,767
1734	Peak Real Power Demand 3-Phase Total	kW/Scale Factor E	0 to ±32,767
1735	Average Power Factor for Peak Real	Percent in 1000ths	-100 to 1000 to +100
1736	Reactive Power Demand for Peak Real	kVAr/Scale Factor E	0 to ±32,767
1737	Apparent Power Demand for Peak Real	kVA/Scale Factor E	0 to 32,767
1738	Peak Reactive Power Demand, 3-Phase Total	kVAr/Scale Factor E	0 to ±32,767
1739	Average Reactive Power Factor for Peak Reactive	Percent in 1000ths	-100 to 1000 to +100
1740	Real Power Demand for Peak Reactive	kW/Scale Factor E	0 to ±32,767
1741	Apparent Power Demand for Peak Reactive	kVA/Scale Factor E	0 to 32,767
1742	Peak Apparent Power Demand, 3-Phase Total	kVA/Scale Factor E	0 to 32,767
1743	Average Apparent Power Factor for Peak Apparent	Percent in 1000ths	-100 to 1000 to +100
1744	Real Power Demand for Peak Apparent	kW/Scale Factor E	0 to ±32,767
1745	Reactive Power Demand for Peak Apparent	kVAr/Scale Factor E	0 to ±32,767
1746	Predicted Real Power Demand, 3 Phase Total	kW/Scale Factor E	0 to ±32,767
1747	Predicted Reactive Power Demand, 3-Phase Total	kVAr/Scale Factor E	0 to 32,767
1748	Predicted Apparent Power Demand, 3-Phase Total	kVA/Scale Factor E	0 to 32,767
1749	Maximum Real Power 3-Phase Demand Over Last Inc. Energy Interval	kW/Scale Factor E	0 to 32,767
1750	Maximum Reactive Power 3-Phase Demand Over Last Inc. Energy Interval	kVAr/Scale Factor E	0 to 32,767
1751	Maximum Apparent Power 3-Phase Demand Over Last Inc. Energy Interval	kVA/Scale Factor E	0 to 32,767
1752	Time Remaining in Demand Interval	Seconds	0 to 3600

<u>Reg. No.</u>	<u>Description</u>	<u>Units</u>	<u>Range</u>
-----------------	--------------------	--------------	--------------

**DATE/TIME (Compressed, 3 register format)**

The date and time in registers 1800–1802 are stored as follows. Other dates and times (through register 1877) are stored in an identical manner.

\*Register 1800, Month (byte 1) = 1–12, Day (byte 2) = 1–31  
 Register 1801, Year (byte 1) = 0–199, Hour (byte 2) = 0–23,  
 Register 1802, Minutes (byte 1) = 0–59, Seconds (byte 2) = 0–59  
 The year is zero based on the year 1900 in anticipation of the 21st century, (e.g., 1989 would be represented as 89 and 2009 would be represented as 109).

1800–1802	Last Restart Date/Time	Month, Day, Yr., Hr., Min., Sec.	*See Above
1803–1805	Date/Time Demand of Peak Current Phase A	Month, Day, Yr., Hr., Min., Sec.	Same as Regs. 1800–1802
1806–1808	Date/Time Demand of Peak Current Phase B	Month, Day, Yr., Hr., Min., Sec.	Same as Regs. 1800–1802
1809–1811	Date/Time Demand of Peak Current Phase C	Month, Day, Yr., Hr., Min., Sec.	Same as Regs. 1800–1802
1812–1814	Date/Time of Peak Demand (Average Real Power)	Month, Day, Yr., Hr., Min., Sec.	Same as Regs. 1800–1802
1815–1817	Date/Time of Last Reset of Peak Demand Current	Month, Day, Yr., Hr., Min., Sec.	Same as Regs. 1800–1802
1818–1820	Date/Time of last Min/Max Clear of Instantaneous Values	Month, Day, Yr., Hr., Min., Sec.	Same as Regs. 1800–1802
1821–1823	Date/Time of Last Write to Circuit Tracker™ Setpoint Register	Month, Day, Yr., Hr., Min., Sec.	Same as Regs. 1800–1802
1824–1826	Date/Time When Peak Power Demand Was Last Reset	Month, Day, Yr., Hr., Min., Sec.	Same as Regs. 1800–1802
1827–1829	Date/Time When Accumulated Energy Was Last Cleared	Month, Day, Yr., Hr., Min., Sec.	Same as Regs. 1800–1802
1830–1832	Date/Time When Control Power Failed Last	Month, Day, Yr., Hr., Min., Sec.	Same as Regs. 1800–1802
1833–1835	Date/Time When Level 1 Energy Mgmt. Setpt. Alarm Period Was Last Entered	Month, Day, Yr., Hr., Min., Sec.	Same as Regs. 1800–1802
1836–1838	Date/Time When Level 2 Energy Mgmt. Setpt. Alarm Period Was Last Entered	Month, Day, Yr., Hr., Min., Sec.	Same as Regs. 1800–1802
1839–1841	Date/Time When Level 3 Energy Mgmt. Setpt. Alarm Period Was Last Entered	Month, Day, Yr., Hr., Min., Sec.	Same as Regs. 1800–1802
1842–1844	Present/Set Date/Time	Month, Day, Yr., Hr., Min., Sec.	Same as Regs. 1800–1802
1845–1847	Date/Time of Calibration	Month, Day, Yr., Hr., Min., Sec.	Same as Regs. 1800–1802
1848–1850	Date/Time of Peak K-Factor Demand A Product	Month, Day, Yr., Hr., Min., Sec.	Same as Regs. 1800–1802

<u>Reg. No.</u>	<u>Description</u>	<u>Units</u>	<u>Range</u>
1851–1853	Date/Time of Peak K-Factor Demand B Product	Month, Day, Yr., Hr., Min., Sec.	Same as Regs. 1800–1802
1854–1856	Date/Time of Peak K-Factor Demand C Product	Month, Day, Yr., Hr., Min., Sec.	Same as Regs. 1800–1802
1857–1859	Date/Time of Peak Reactive Demand Power	Month, Day, Yr., Hr., Min., Sec.	Same as Regs. 1800–1802
1860–1862	Date/Time of Peak Apparent Demand Power	Month, Day, Yr., Hr., Min., Sec.	Same as Regs. 1800–1802
1863–1865	Incremental Energy Start Time of Day	Month, Day, Yr., Hr., Min., Sec.	Same as Regs. 1800–1802
1866–1868	Date/Time when Conditional Energy Last Cleared	Month, Day, Yr., Hr., Min., Sec.	Same as Regs. 1800–1802
1869–1871	Incremental Energy Last Update Date/Time	Month, Day, Yr., Hr., Min., Sec.	Same as Regs. 1800–1802
1872–1874	Date/Time of Peak 3-Phase Avg Current Demand	Month, Day, Yr., Hr., Min., Sec.	Same as Regs. 1800–1802
1875–1877	Date/Time of Peak Neutral Current Demand	Month, Day, Yr., Hr., Min., Sec.	Same as Regs. 1800–1802

<u>Reg. No.</u>	<u>Description</u>	<u>Units</u>	<u>Range</u>
1878–1880	Date/Time of Peak Real Power Demand Last Incremental Energy Period	Month, Day, Yr., Hr., Min., Sec.	Same as Regs. 1800–1802
1881–1883	Date/Time of Peak Reactive Power Demand Last Incremental Energy Period	Month, Day, Yr., Hr., Min., Sec.	Same as Regs. 1800–1802
1884–1886	Date/Time of Peak Apparent Power Demand Last Incremental Energy Period	Month, Day, Yr., Hr., Min., Sec.	Same as Regs. 1800–1802
1887–1892	Reserved	Month, Day, Yr., Hr., Min., Sec.	Same as Regs. 1800–1802
1893–1898	Present Date/Time 6-register format	Sec., Min., Hr., Day, Month, Yr.	Same as Regs. 700–705

**DATE/TIME Expanded (6 registers)**

The date and time in registers 700–705 are stored as follows. Other dates and times through register 795 are stored in an identical manner.

\*Seconds (Reg. 700) = 0–59, Minutes (Reg. 701) = 0–59, Hours (Reg. 702) = 0–23,  
 Day (Reg. 703) 1–31, Month (Reg. 704) = 1–12, Year (Reg. 705) = 1900–2099  
 The date and time are mapped from CM Registers 1800–1802.

<u>Reg. No.</u>	<u>Description</u>	<u>Units</u>	<u>Range</u>
[700–705]	Last Restart Date/Time	Sec, Min, Hour Day, Month, Yr.	*See above
[706–711]	Date/Time Demand of Peak Current Phase A	Sec, Min, Hour Day, Month, Yr.	Same as Regs. # 700–705

<u>Reg. No.</u>	<u>Description</u>	<u>Units</u>	<u>Range</u>
[712–717]	Date/Time Demand of Peak Current Phase B	Sec, Min, Hour Day, Month, Yr.	Same as Regs. # 700–705
[718–723]	Date/Time Demand of Peak Current Phase C	Sec, Min, Hour Day, Month, Yr.	Same as Regs. # 700–705
[724–729]	Date/Time of Peak Demand (Average Real Power)	Sec, Min, Hour Day, Month, Yr.	Same as Regs. # 700–705
[730–735]	Date/Time of Last Reset of Peak Demand Current	Sec, Min, Hour Day, Month, Yr.	Same as Regs. # 700–705
[736–741]	Date/Time of last Min/Max Clear of Instantaneous Values	Sec, Min, Hour Day, Month, Yr.	Same as Regs. # 700–705
[742–747]	Date/Time of Last Write to Circuit Tracker™ Setpoint Register	Sec, Min, Hour Day, Month, Yr.	Same as Regs. # 700–705
[748–753]	Date/Time when Peak Demand was Last Cleared	Sec, Min, Hour Day, Month, Yr.	Same as Regs. # 700–705
[754–759]	Date/Time when Accumulated Energy was Last Cleared	Sec, Min, Hour Day, Month, Yr.	Same as Regs. # 700–705
[760–765]	Date/Time when Control Power Failed Last	Day, Month, Yr. Sec, Min, Hour	Regs. # 700–705 Same as
[766–771]	Date/Time When Level 1 Energy Mgmt. Setpt. Alarm Period was Last Entered	Sec, Min, Hour Day, Month, Yr.	Same as Regs. # 700–705
[772–777]	Date/Time When Level 2 Energy Mgmt. Setpt. Alarm Period was Last Entered	Sec, Min, Hour Day, Month, Yr.	Same as Regs. # 700–705
[778–783]	Date/Time When Level 3 Energy Mgmt. Setpt. Alarm Period was Last Entered	Sec, Min, Hour Day, Month, Yr.	Same as Regs. # 700–705
[784–789]	Present/Set Date/Time	Sec, Min, Hour Day, Month, Yr.	Same as Regs. # 700–705
[790–795]	Date/Time of Calibration	Sec, Min, Hour Day, Month, Yr.	Same as Regs. # 700–705

**STATUS INPUTS**

2400	Input Status	None	0000 to 00FF Hex
2401	Input Conditional Energy Control	None	0000 to 00FF Hex
2402–2403	Input 1 Label	None	Alpha-Numeric 4 Chars.
2404–2405	Input 1 Count	Counts	0 to 99,999,999
2406	Input 1 On-Timer	Seconds	0 to 32,767
2407–2408	Input 2 Label	None	Alpha-Numeric 4 Chars.
2409–2410	Input 2 Count	Counts	0 to 99,999,999
2411	Input 2 On-Timer	Seconds	0 to 32,767

<u>Reg. No.</u>	<u>Description</u>	<u>Units</u>	<u>Range</u>
2412–2413	Input 3 Label	None	Alpha-Numeric 4 Chars.
2414–2415	Input 3 Count	Counts	0 to 99,999,999
2416	Input 3 On-Timer	Seconds	0 to 32,767
2417–2418	Input 4 Label	None	Alpha-Numeric 4 Chars.
2419–2420	Input 4 Count	Counts	0 to 99,999,999
2421	Input 4 On-Timer	Seconds	0 to 32,767
2422–2423	Input 5 Label	None	Alpha-Numeric 4 Chars.
2424–2425	Input 5 Count	Counts	0 to 99,999,999
2426	Input 5 On-Timer	Seconds	0 to 32,767
2427–2428	Input 6 Label	None	Alpha-Numeric 4 Chars.
2429–2430	Input 6 Count	Counts	0 to 99,999,999
2431	Input 6 On-Timer	Seconds	0 to 32,767
2432–2433	Input 7 Label	None	Alpha-Numeric 4 Chars.
2434–2435	Input 7 Count	Counts	0 to 99,999,999
2436	Input 7 On-Timer	Seconds	0 to 32,767
2437–2438	Input 8 Label	None	Alpha-Numeric 4 Chars.
2439–2440	Input 8 Count	Counts	0 to 99,999,999
2441	Input 8 On-Timer	Seconds	0 to 32,767

**KYZ and RELAY OUTPUTS**

2500	Output Status	None	0000 to 00FF Hex	Bit Map of the states of the Outputs. A 1=On, a 0=Off. Bit 1 represents the KYZ Output, bits 2–4 represent relays R1–R3, respectively. Register 235 is ghosted as Read Only and does not provide control.
2501	Output Control State Bit Mask	None	0000 to FFFF Hex	Bit Map indicating active Relay Control states. The lower byte indicates the status of internal/external control. A 1=Relay Control is under internal control and a 0=Relay Control is under external control. The upper byte indicates the status of override control. A 1=Relay Control is in override and a 0=Relay Control is not in override. For each byte, Bit 1 represents the KYZ pulse output, and bits 2–4 represent relays R1–R3, respectively.
2502–2503	KYZ Output Label	None	Alpha-Numeric 4 Chars. (2 Regs.)	Label for KYZ output.
2504	KYZ Output Mode Reg.	None	0 to 9	KYZ Output Mode Register: 0=Normal, 1=Latched, 2=Timed, 3=Absolute kWh pulse, 4=Absolute kVArH pulse, 5=kVAH pulse, 6=kWH in pulse, 7=kVarH in pulse, 8=kWH out pulse, 9=kVArH out pulse
2505	KYZ Output Parameter Register	Seconds	0 to 32,767	This register specifies the time the KYZ output is to remain closed for timed mode.

<b>Reg. No.</b>	<b>Name</b>	<b>Units</b>	<b>Range</b>	<b>Description</b>
2506	KYZ Output kWH, kVArH or kVAH /Pulse Register	kWH/Pulse or kVArH/Pulse or kVAH/Pulse In 10ths	0 to 32,767	This register specifies the kWH, kVArH or kVAH per pulse for the KYZ output when in those modes.
2507–2508	Relay R1 Label	None	Alpha-Numeric 4 Chars. (2 Regs.)	Label for relay R1.
2509	Relay R1 Mode Reg.	None	0 to 9	Relay R1 Mode Register: 0=Normal, 1=Latched, 2=Timed, 3=Absolute kWH pulse, 4=Absolute kVArH pulse, 5=kVAH pulse 6=kWH in pulse, 7=kVArH in pulse, 8=kWH out pulse, 9=kVArH out pulse
2510	Relay R1 Parameter Register	Seconds	0 to 32,767	This register specifies the time relay R1 is to remain closed for timed mode.
2511	Relay R1 kWH, kVArH or kVAH/ Pulse Register	kWH/Pulse or kVArH/Pulse or kVAH/Pulse In 10ths	0 to 32,767	This register specifies the kWH, kVArH or kVAH per pulse for relay R1 when in those modes.
2512–2513	Relay R2 Label	None	Alpha-Numeric 4 Chars. (2 Regs.)	Label for relay R2.
2514	Relay R2 Mode Reg.	None	0 to 9	Relay R2 Mode Register: 0=Normal, 1=Latched, 2=Timed, 3=Absolute kWH pulse, 4=Absolute kVArH pulse, 5=kVAH pulse 6=kWH in pulse, 7=kVArH in pulse, 8=kWH out pulse, 9=kVArH out pulse
2515	Relay R2 Parameter Register	Seconds	0 to 32,767	This register specifies the time relay R2 is to remain closed for timed mode.
2516	Relay R2 kWH, kVArH or kVAH/ Pulse Register	kWH/Pulse or kVArH/Pulse or kVAH/Pulse In 10ths	0 to 32,767	This register specifies the kWH, kVArH or kVAH per pulse for relay R2 when in those modes.
2517–2518	Relay R3 Label	None	Alpha-Numeric 4 Chars. (2 Regs.)	Label for relay R3.
2519	Relay R3 Mode Reg.	None	0 to 9	Relay R3 Mode Register: 0=Normal, 1=Latched, 2=Timed, 3=Absolute kWH pulse, 4=Absolute kVArH pulse, 5=kVAH pulse 6=kWH in pulse, 7=kVArH in pulse, 8=kWH out pulse, 9=kVArH out pulse
2520	Relay R3 Parameter Register	Seconds	0 to 32,767	This register specifies the time relay R3 is to remain closed for timed mode.
2521	Relay R3 kWH, kVArH or kVAH /Pulse Register	kWH/Pulse or kVArH/Pulse or kVAH/Pulse In 10ths	0 to 32,767	This register specifies the kWH, kVArH or kVAH per pulse for relay R3 when in those modes.

<u>Reg. No.</u>	<u>Description</u>	<u>Units</u>	<u>Range</u>
<b><u>CIRCUIT MONITOR CONFIGURATION VALUES</u></b>			
2001	System Connection	None	30=3-wire mode 40=4-wire with calculated neutral 41=4-wire with metered neutral 42=4-wire, 2-1/2 element with calculated neutral 43=4-wire, 2-1/2 element with metered neutral
2002	CT Ratio 3-Phase Primary Ratio Term	None	1 to 32,767
2003	CT Ratio 3-Phase Secondary Ratio Term	None	1 to 5
2004	CT Ratio Neutral Primary Ratio Term	None	1 to 32,767
2005	CT Ratio Neutral Secondary Ratio Term	None	1 to 5
2006	PT Ratio 3-Phase Primary Ratio Term	None	1 to 32,767
2007	PT Ratio 3-Phase Primary Scale Factor	None	0 to 2
2008	PT Ratio 3-Phase Secondary Ratio Term	None	1 to 600
2009	CT Ratio Correction Factors Phase A	In 10,000ths	5,000–20,000
2010	CT Ratio Correction Factors Phase B	In 10,000ths	5,000–20,000
2011	CT Ratio Correction Factors Phase C	In 10,000ths	5,000–20,000
2012	CT Ratio Correction Factors Neutral /Ground	In 10,000ths	5,000–20,000
2013	PT Ratio Correction Factors Phase A	In 10,000ths	5,000–20,000
2014	PT Ratio Correction Factors Phase B	In 10,000ths	5,000–20,000
2015	PT Ratio Correction Factors Phase C	In 10,000ths	5,000–20,000
2016	Nominal System Frequency		

<u>Reg. No.</u>	<u>Name</u>	<u>Units</u>	<u>Range</u>	<u>Description</u>
2020	Scale Group A: Ammeter Per Phase	None	-2 to 1	Scale Group A: Ammeter Per Phase -2= scale by 0.01 -1=scale by 0.10 0=scale by 1.00 (default) 1=scale by 10.0
2021	Scale Group B: Ammeter Neutral	None	-2 to 1	Scale Group B: Ammeter Neutral -2=scale by 0.01 -1=scale by 0.10 0=scale by 1.00 (default) 1=scale by 10.0



<u>Reg. No.</u>	<u>Name</u>	<u>Units</u>	<u>Range</u>	<u>Description</u>
2022	Scale Group C: Ammeter Ground	None	-2 to 1	Scale Group C: Ammeter Ground -2=scale by 0.01 -1=scale by 0.10 0=scale by 1.00 (default) 1=scale by 10.0
2023	Scale Group D: Voltmeter	None	-1 to 2	Scale Group D: Voltmeter -1=scale by 0.10 0=scale by 1.00 (default) 1=scale by 10.0 2=scale by 100
2024	Scale Group E: kwattmeter, kVarmeter, kVa	None	-3 to 3	Scale Group E: kWattmeter, kVarmeter, kVA -3=scale by .001 -2=scale by 0.01 -1=scale by 0.10 0=scale by 1.00 (default) 1=scale by 10.0 2=scale by 100 3=scale by 1000 4=scale by 10,000 5=scale by 100,000
2025	Scale Group F: Frequency	None	-1 to 2	Scale Group F: Frequency (Determined by CM) -2=scale by 0.01 (50/60) -1=scale by 0.10 (400)
2027	Energy Resolution on Front Panel	None	0 10–13 20–23	Front panel energy display can be configured for various resolutions (max.value illustrated for each selection). Write a: 0=999999 kilo 10=999999 kilo 11=99999.9 kilo 12=9999.99 kilo 13=999.999 kilo 20=999999 mega 21=99999.9 mega 22=9999.99 mega 23=999.999 mega
<u>Reg. No.</u>	<u>Name</u>	<u>Units</u>	<u>Range</u>	<u>Description</u>
2028	Command Password	None	0 to 9998	
2029	Display Setup Password	None	0 to 9998	Full Access Front Panel Reset Password
2031	Reset Access Password	None	0 to 9998 or -32,768	Limited Front Panel Reset Password. When set to -32,768, the Configuration password is used to access Resets.
2032	Limited Access Disable Bit Mask	None	0 to F (Hex)	Limited Front Panel Reset Disable Bit Mask. A 1=Disable. Bit 1=Disable Demand Amps Reset Capability Bit 2=Disable Demand Power Reset Capability Bit 3=Disable Energy Reset Capability Bit 4=Disable Min/Max Reset Capability
2038	Sag/Swell Suspend Bit map	None	0 to 17 (Hex)	Sag/Swell Suspend Status. A1 means condition exists. Bit 1=Set if any other bit is set Bit 2=Sag/Swell disabled Bit 3=CPML feature disabled Bit 4=Sag/Swell Suspended Temporarily Bit 5=Sag/Swell Suspended Permanently

<u>Reg. No.</u>	<u>Name</u>	<u>Units</u>	<u>Range</u>
2040–2041	CM Label	None	Any Valid Alpha-Numeric
2042–2049	CM Nameplate	None	Any Valid Alpha-Numeric
2076	Incremental Energy Interval	Minutes	0 to 1,440 minutes
2077	Power Demand Interval	Minutes	0 to 60 @5min. Multiples
2078	Power Demand Sub-Interval	Minutes	0 to 60 @5min. Multiples
2079	Current Demand K-Factor Demand Interval in minutes	Minutes	0 to 60 @5min. Multiples

<u>Reg. No.</u>	<u>Name</u>	<u>Units</u>	<u>Range</u>	<u>Description</u>
2080	Energy Accum. Mode Selections Bit map	None	0 or 1	Circuit Monitor Energy Accumulation Mode Selections Bit Map. Bit 1 indicates real & reactive energy accumulation method: a 0 indicates absolute a 1 indicates signed
2081	Operating Mode Selections Bit map	None	0 to 7F	Circuit Monitor Operating Mode Selections Bit Map. Bit 1 indicates real & reactive energy accumulation method: 0 indicates absolute (default) 1 indicates signed Bit 2 indicates Reactive Energy and Demand accumulation method: 0 specifies fundamental only (default) 1 specifies to include harmonic cross products - (displacement & distortion) Bit 3 indicates VAr/PF sign convention: 0 indicates CM1 convention (default) 1 indicates alternate convention Bit 4 indicates Demand Power calculation method: 0 indicates Thermal Demand (default) 1 indicates a Block/Rolling Interval Demand Bit 5 indicates external power demand synch. driver source if applicable: 0 Specifies Input 1 as the source (default) 1 Specifies Command Interface as the source Bit 6 indicates which mechanism controls cond. energy 0 indicates status inputs (default) 1 indicates command I/F Bit 7 indicates status of conditional energy accumulation: 0 indicates Cond Energy Accum is off (default) 1 indicates Cond Energy Accum is on Bit 8 is unused. Bit 9 indicates status of Unit #1 response to enquire 0 indicates response is enabled (default) 1 indicates response is disabled Bit 10 indicates whether front comm port is enabled 0 indicates front comm port is enabled (default) 1 indicates front comm port is disabled Bit 11 indicates whether front panel setup is enabled 0 indicates front panel setup is enabled (default) 1 indicates front panel setup is disabled Bit 12 indicates status of log and wfc files master enable 0 indicates files are enabled (default) 1 indicates files are disabled All other bits are unused.

<u>Reg. No.</u>	<u>Name</u>	<u>Units</u>	<u>Range</u>	<u>Description</u>
2083	Present Day of the Week	None	0 to 6	Present Day of the Week 0=Sunday 1=Monday 2=Tuesday 3=Wednesday 4=Thursday 5=Friday 6=Saturday
2085	Square D Product I.D. Number equal to 460 for CMA Model A	None	0 to 3000	Square D Product I.D. Number equal to: 460 for 2050 461 for 2150 462 for 2250 463 for 2350 464 for 2450 465 for 2452
2088	On-board non-volatile memory	Bytes	0 to 1131	Amount of on-board non-volatile memory present
2091	Prior PLOS Rev. Sub-Level	None	0 to 9999	Prior PLOS revision sublevel before last firmware download. Zero if not applicable.
2092	Prior PLOS Revision Level	None	01:00 to 99:99	Prior PLOS revision level before last firmware download. Zero if not applicable.
2093	PLOS Rev. Sublevel	None	0 to 9999	PLOS revision sublevel—used for diagnostic purposes only.
2094	Firmware Revision Level	None	01:00 to 99:99	Firmware Revision Level in decimal. The first two digits after the equal sign represent the revision of the reset/boot code. The last two digits represent the revision of the downloadable PLOS code.
2123	CT Phase Shift Correction (1 Amp)	Degrees in 100ths	-1000 to 1000	CT phase shift compensation at 1 Amp.
2124	CT Phase Shift Correction (5 Amps)	Degrees in 100ths	-1000 to 1000	CT phase shift compensation at 5 Amps.
<u>Reg. No.</u>	<u>Name</u>	<u>Units</u>	<u>Range</u>	<u>Description</u>
<b>GENERIC DEMAND</b>				
2200	Generic Demand Reset Selection	None		Generic Demand Reset Selection 0 = CMD 5110 & 5112 1 = CMD 5112 only
2201	Generic Demand interval	Minutes	5–60	Interval for generic demand calculation (thermal demand) default = 5
2202–2204	Date/Time of last generic demand maximum/minimum reset	Mo., Day, Yr. Hr., Min., Sec.	Same as Regs. 1800–1802	Date/Time of last generic demand maximum/minimum reset
2205–2224	Selected registers of quantities to perform generic demand calculations	None	Regs. 1001–1199 2000–2999 3000–3999 4000–5199	Generic demand calculation performed on value stored in these registers. Regs. 2205–2212 are defaulted to voltage registers 1014–1021.
2225–2229	Reserved			

<u>Reg. No.</u>	<u>Name</u>	<u>Units</u>	<u>Range</u>	<u>Description</u>
2202-2204	Generic Demand Value, 1, present demand	None	0 to 32,767	Present demand value for generic demand value #1
2331	Generic Demand Value, 1, Peak Demand	None	0 to 32,767	Peak demand value for generic demand value #1
2332	Generic Demand Value, 1, Minimum Demand	None	0 to 32,767	Minimum demand value for generic demand value #1
2233-2235	(The definitions for registers 2233-2235 are the same as for 2230-2232, except that they apply to generic demand value #2.)			
2236-2238	(The definitions for registers 2236-2238 are the same as for 2230-2232, except that they apply to generic demand value #3.)			
2239-2241	(The definitions for registers 2239-2241 are the same as for 2230-2232, except that they apply to generic demand value #4.)			
2242-2244	(The definitions for registers 2242-2244 are the same as for 2230-2232, except that they apply to generic demand value #5.)			
2245-2247	(The definitions for registers 2245-2247 are the same as for 2230-2232, except that they apply to generic demand value #6.)			
2248-2250	(The definitions for registers 2248-2250 are the same as for 2230-2232, except that they apply to generic demand value #7.)			
2251-2253	(The definitions for registers 2251-2253 are the same as for 2230-2232, except that they apply to generic demand value #8.)			
2254-2256	(The definitions for registers 2254-2256 are the same as for 2230-2232, except that they apply to generic demand value #9.)			
2257-2259	(The definitions for registers 2257-2259 are the same as for 2230-2232, except that they apply to generic demand value #10.)			
2260-2262	(The definitions for registers 2260-2262 are the same as for 2230-2232, except that they apply to generic demand value #11.)			
2263-2265	(The definitions for registers 2263-2265 are the same as for 2230-2232, except that they apply to generic demand value #12.)			
2266-2268	(The definitions for registers 2266-2268 are the same as for 2230-2232, except that they apply to generic demand value #13.)			
2269-2271	(The definitions for registers 2269-2271 are the same as for 2230-2232, except that they apply to generic demand value #14.)			
2272-2274	(The definitions for registers 2272-2274 are the same as for 2230-2232, except that they apply to generic demand value #15.)			
2275-2277	(The definitions for registers 2275-2277 are the same as for 2230-2232, except that they apply to generic demand value #16.)			
2278-2280	(The definitions for registers 2278-2280 are the same as for 2230-2232, except that they apply to generic demand value #17.)			
2281-2283	(The definitions for registers 2281-2283 are the same as for 2230-2232, except that they apply to generic demand value #18.)			
2284-2286	(The definitions for registers 2284-2286 are the same as for 2230-2232, except that they apply to generic demand value #19.)			
2287-2289	(The definitions for registers 2287-2289 are the same as for 2230-2232, except that they apply to generic demand value #20.)			

<u>Reg. No.</u>	<u>Description</u>	<u>Units</u>	<u>Range</u>
<b><u>DATE/TIME (GENERIC DEMAND PEAKS AND MINIMUMS FOR FIRST 10 VALUES)</u></b>			
1900-1902	Date/Time of Peak Demand Value #1	Month, Day, Yr. Hr., Min., Sec.	Same as Regs. 1800-1802
1903-1905	Date/Time of Minimum Demand Value #1	Month, Day, Yr. Hr., Min., Sec.	Same as Regs. 1800-1802
1906-1908	Date/Time of Peak Demand Value #2	Month, Day, Yr. Hr., Min., Sec.	Same as Regs. 1800-1802
1909-1911	Date/Time of Minimum Demand Value #2	Month, Day, Yr. Hr., Min., Sec.	Same as Regs. 1800-1802
1912-1914	Date/Time of Peak Demand Value #3	Month, Day, Yr. Hr., Min., Sec.	Same as Regs. 1800-1802
1915-1917	Date/Time of Minimum Demand Value #3	Month, Day, Yr. Hr., Min., Sec.	Same as Regs. 1800-1802

<u>Reg. No.</u>	<u>Description</u>	<u>Units</u>	<u>Range</u>
1918–1920	Date/Time of Peak Demand Value #4	Month, Day, Yr. Hr., Min., Sec.	Same as Regs. 1800–1802
1921–1923	Date/Time of Minimum Demand Value #4	Month, Day, Yr. Hr., Min., Sec.	Same as Regs. 1800–1802
1924–1926	Date/Time of Peak Demand Value #5	Month, Day, Yr. Hr., Min., Sec.	Same as Regs. 1800–1802
1927–1929	Date/Time of Minimum Demand Value #5	Month, Day, Yr. Hr., Min., Sec.	Same as Regs. 1800–1802
1930–1932	Date/Time of Peak Demand Value #6	Month, Day, Yr. Hr., Min., Sec.	Same as Regs. 1800–1802
1933–1935	Date/Time of Minimum Demand Value #6	Month, Day, Yr. Hr., Min., Sec.	Same as Regs. 1800–1802
1936–1938	Date/Time of Peak Demand Value #7	Month, Day, Yr. Hr., Min., Sec.	Same as Regs. 1800–1802
1939–1941	Date/Time of Minimum Demand Value #7	Month, Day, Yr. Hr., Min., Sec.	Same as Regs. 1800–1802
1942–1944	Date/Time of Peak Demand Value #8	Month, Day, Yr. Hr., Min., Sec.	Same as Regs. 1800–1802
1945–1947	Date/Time of Minimum Demand Value #8	Month, Day, Yr. Hr., Min., Sec.	Same as Regs. 1800–1802
1948–1950	Date/Time of Peak Demand Value #9	Month, Day, Yr. Hr., Min., Sec.	Same as Regs. 1800–1802
1951–1953	Date/Time of Minimum Demand Value #9	Month, Day, Yr. Hr., Min., Sec.	Same as Regs. 1800–1802
1954–1956	Date/Time of Peak Demand Value #10	Month, Day, Yr. Hr., Min., Sec.	Same as Regs. 1800–1802
1957–1959	Date/Time of Minimum Demand Value #10	Month, Day, Yr. Hr., Min., Sec.	Same as Regs. 1800–1802

<u>Reg. No.</u>	<u>Name</u>	<u>Units</u>	<u>Range</u>	<u>Description</u>
-----------------	-------------	--------------	--------------	--------------------

**MAGNITUDE AND DURATION OF LAST SAG/SWELL EVENT**

*Note: Registers 2300–2341 apply to circuit monitor models CM-2350 and higher only.*

2300	Last Voltage A Swell Extreme Value	Units/Scale Factor D	0–32767	Voltage A swell extreme value
2301–2302	Last Voltage A Swell Event Duration	Cycles	1–99999999	Voltage A swell event duration
2303	Last Voltage B Swell Extreme Value	Volts/Scale Factor D	0–32767	Voltage B swell extreme value
2304–2305	Last Voltage B Swell Event Duration	Cycles	1–99999999	Voltage B swell event duration
2306	Last Voltage C Swell Extreme Value	Volts/Scale Factor D	0–32767	Voltage C swell extreme value
2307–2308	Last Voltage C Swell Event Duration	Cycles	1–99999999	Voltage C swell event duration
2309	Last Current A Swell Extreme Value	Amps/Scale Factor A	0–32767	Current A swell extreme value
2310–2311	Last Current A Swell Event Duration	Cycles	1–99999999	Current A swell event duration
2312	Last Current B Swell Extreme Value	Amps/Scale Factor A	0–32767	Current B swell extreme value
2313–2314	Last Current B Swell Event Duration	Cycles	1–99999999	Current B swell event duration
2315	Last Current C Swell Extreme Value	Amps/Scale Factor A	0–32767	Current C swell extreme value
2316–2317	Last Current C Swell Event Duration	Cycles	1–99999999	Current C swell event duration
2318	Last Current N Swell Extreme Value	Amps/Scale Factor B	0–32767	Current N swell extreme value
2319–2320	Last Current N Swell Event Duration	Cycles	1–99999999	Current N swell event duration

<u>Reg. No.</u>	<u>Name</u>	<u>Units</u>	<u>Range</u>	<u>Description</u>
2321	Last Voltage A Sag Extreme Value	Volts/Scale Factor D	0–32767	Voltage A sag extreme value
2322–2323	Last Voltage A Sag Event Duration	Cycles	1–99999999	Voltage A sag event duration
2324	Last Voltage B Sag Extreme Value	Volts/Scale Factor D	0–32767	Voltage B sag extreme value
2325–2326	Last Voltage B Sag Event Duration	Cycles	1–99999999	Voltage B sag event duration
2327	Last Voltage C Sag Extreme Value	Volts/Scale Factor D	0–32767	Voltage C sag extreme value
2328–2329	Last Voltage C Sag Event Duration	Cycles	1–99999999	Voltage C sag event duration
2330	Last Current A Sag Extreme Value	Amps/Scale Factor A	0–32767	Current A sag extreme value
2331–2332	Last Current A Sag Event Duration	Cycles	1–99999999	Current A sag event duration
2333	Last Current B Sag Extreme Value	Amps/Scale Factor A	0–32767	Current B sag extreme value
2334–2335	Last Current B Sag Event Duration	Cycles	1–99999999	Current B sag event duration
2336	Last Current C Sag Extreme Value	Amps/Scale Factor A	0–32767	Current C sag extreme value
2337–2338	Last Current C Sag Event Duration	Cycles	1–99999999	Current C sag event duration
2339	Last Current N Sag Extreme Value	Amps/Scale Factor B	0–32767	Current N sag extreme value
2340–2341	Last Current N Sag Event Duration	Cycles	1–99999999	Current N sag event duration

<u>Reg. No.</u>	<u>Name</u>	<u>Units</u>	<u>Range</u>	<u>Description</u>
-----------------	-------------	--------------	--------------	--------------------

**ANALOG OUTPUT CONFIGURATION REGISTERS**

2600-2601	Analog Output 1 Label	None	Alphanumeric (4 chars)	A four character label used to identify this output.
2602	Analog Output 1 Enable	None	0 or 1	Enables or disables this output. 0 = Off; 1 = On.
2603	Analog Output 1 Register Number	None	Any valid reg	The circuit monitor register number assigned to this analog output.
2604	Analog Output 1 Lower Limit	None	-32767 to Upper Limit	The register value that is equivalent to the minimum output current (0 or 4 mA).
2605	Analog Output 1 Upper Limit	None	Lower Limit to 32,767	The register value that is equivalent to the maximum output current (1 mA or 20 mA).

(The description for registers 2608–2613 is the same as 2600–2605)

2608–2609	Analog Output 2 Label			
2610	Analog Output 2 Enable			
2611	Analog Output 2 Register Number			
2612	Analog Output 2 Lower Limit			
2613	Analog Output 2 Upper Limit			

(The description for registers 2616–2621 is the same as 2600–2605)

2616–2617	Analog Output 3 Label			
2618	Analog Output 3 Enable			
2619	Analog Output 3 Register Number			
2620	Analog Output 3 Lower Limit			
2621	Analog Output 3 Upper Limit			

(The description for registers 2624–2629 is the same as 2600–2605)

2624–2625	Analog Output 4 Label			
2626	Analog Output 4 Enable			
2627	Analog Output 4 Register Number			
2628	Analog Output 4 Lower Limit			
2629	Analog Output 4 Upper Limit			

<u>Reg. No.</u>	<u>Name</u>	<u>Units</u>	<u>Range</u>	<u>Description</u>
<b>ANALOG INPUT CONFIGURATION REGISTERS</b>				
2700–2702	Analog Input 1 Units	None	Alphanumeric (6 chars)	A six character label used to identify this input.
2703	Analog Input 1 Precision	None	-3 to +3	The precision of the measured analog value.
2704	Analog Input 1 Input Type	None	0 or 1	Specifies whether the input is wired to a 0-5 V source, or a 4–20 mA source using the internal 250 ohm resistor. 0 = 0–5; 1 = 4–20.
2705	Analog Input 1 Offset Voltage	in 100ths	0 to 500	The lowest input voltage (in hundredths of a volt) that represents a valid reading. When the input voltage is equal to this value, the circuit monitor reports the <i>lower limit</i> , defined in register 2706.
2706	Analog Input 1 Lower Limit	None	-32767 to Upper Limit	The value the circuit monitor reports when the input voltage is equal to the <i>offset voltage</i> , defined in register 2705.
2707	Analog Input 1 Upper Limit	None	Lower Limit to 32767	The value the circuit monitor reports when the input voltage is equal to 5 volts (the maximum input voltage).
(The description for registers 2710–2717 is the same as 2700–2707)				
2710–2712	Analog Input 2 Units			
2713	Analog Input 2 Precision			
2714	Analog Input 2 Input Type			
2715	Analog Input 2 Offset Voltage			
2716	Analog Input 2 Lower Limit			
2717	Analog Input 2 Upper Limit			
(The description for registers 2720–2727 is the same as 2700–2707)				
2720–2722	Analog Input 3 Units			
2723	Analog Input 3 Precision			
2724	Analog Input 3 Input Type			
2725	Analog Input 3 Offset Voltage			
2726	Analog Input 3 Lower Limit			
2727	Analog Input 3 Upper Limit			
(The description for registers 2730–2737 is the same as 2700–2707)				
2730–2732	Analog Input 4 Units			
2733	Analog Input 4 Precision			
2734	Analog Input 4 Input Type			
2735	Analog Input 4 Offset Voltage			
2736	Analog Input 4 Lower Limit			
2737	Analog Input 4 Upper Limit			

<u>Reg. No.</u>	<u>Name</u>	<u>Units</u>	<u>Range</u>	<u>Description</u>
<b>STATUS INPUT PULSE DEMAND METERING</b>				
<i>Note: Registers 2898–2999 apply to circuit monitor models CM-2150 and higher only.</i>				
2898	Pulse Demand Interval Mode	None	0 to 3	0=Slave to power demand interval (must be block interval mode) 1=Slave to incremental energy interval 2=Synch to status input 1 3=Ext comms synch to command interface
2899	No. of Pulse Demand Intervals	None	0 to 32,767	
2900	Channel 1 Status Input Pulse Demand Bit Map	None	0 to FF	Demand meter bit map specifying which status inputs totalize for this demand channel. Bit 0 represents input 1, etc. Bit 0 represents input 1, etc. 0=exclude 1=include Default value is 0.
2901–2903	Utility Registers	None	–32,767 to +32,767	Utility registers can be defined by custom application software as storage locations for pulse constant, scale factor, unit code, or other.
2904	Present Interval Pulse Count Channel 1	Counts	0 to 32,767	Total number of pulses counted on all specified inputs during present demand interval on this channel.
2905	Last Interval Pulse Count Channel 1	Counts	0 to 32,767	Total number of pulses counted during the last completed interval on this channel.
2906	Peak Interval Pulse Count Channel 1	Counts	0 to 32,767	Peak value of last interval pulse count on this channel since last demand reset.
2907–2909	Date/Time of Peak Interval Pulse Count Channel 1	Month, Day, Yr., Hr., Min., Sec.	Same as Regs. No.1800–1802	Date/time of peak interval pulse count since last reset.
2910–2919	(The definitions for registers 2910–2919 are the same as for 2900–2909, except that they apply to channel 2.)			
2920–2929	(The definitions for registers 2920–2929 are the same as for 2900–2909, except that they apply to channel 3.)			
2930–2939	(The definitions for registers 2930–2939 are the same as for 2900–2909, except that they apply to channel 4.)			
2940–2949	(The definitions for registers 2940–2949 are the same as for 2900–2909, except that they apply to channel 5.)			
2950–2959	(The definitions for registers 2950–2959 are the same as for 2900–2909, except that they apply to channel 6.)			
2960–2969	(The definitions for registers 2960–2969 are the same as for 2900–2909, except that they apply to channel 7.)			
2970–2979	(The definitions for registers 2970–2979 are the same as for 2900–2909, except that they apply to channel 8.)			
2980–2989	(The definitions for registers 2980–2989 are the same as for 2900–2909, except that they apply to channel 9.)			
2990–2999	(The definitions for registers 2990–2999 are the same as for 2900–2909, except that they apply to channel 10.)			

**CIRCUIT MONITOR UTILITY REGISTERS**

6800–6999	Utility Registers	None	0 to +/-32,767	These read/write registers can be used by the application programmer as required. They are saved in non-volatile memory when the circuit monitor loses control power.
-----------	-------------------	------	----------------	---



<u>Reg. No.</u>	<u>Description</u>	<u>Reg. No.</u>	<u>Description</u>	<u>Reg. No.</u>	<u>Description</u>
5611	Event Counter No. 201	5821	Event Counter No. 42	5876	Event Counter No. 97
5612	Event Counter No. 202	5822	Event Counter No. 43	5877	Event Counter No. 98
5613	Event Counter No. 203	5823	Event Counter No. 44	5878	Event Counter No. 99
5614	Event Counter No. 204	5824	Event Counter No. 45	5879	Event Counter No. 100
5615	Event Counter No. 205	5825	Event Counter No. 46	5880	Event Counter No. 101
5616	Event Counter No. 206	5826	Event Counter No. 47	5881	Event Counter No. 102
5617	Event Counter No. 207	5827	Event Counter No. 48	5882	Event Counter No. 103
5618	Event Counter No. 208	5828	Event Counter No. 49	5883	Event Counter No. 104
5619	Event Counter No. 209	5829	Event Counter No. 50	5884	Event Counter No. 105
5620	Event Counter No. 210	5830	Event Counter No. 51	5885	Event Counter No. 106
5621	Event Counter No. 211	5831	Event Counter No. 52	5886	Event Counter No. 107
5622	Event Counter No. 212	5832	Event Counter No. 53	5887	Event Counter No. 108
5623	Event Counter No. 213	5833	Event Counter No. 54	5888	Event Counter No. 109
5624	Event Counter No. 214	5834	Event Counter No. 55	5889	Event Counter No. 110
5780	Event Counter No. 1	5835	Event Counter No. 56	5890	Event Counter No. 111
5781	Event Counter No. 1	5836	Event Counter No. 57	5891	Event Counter No. 112
5782	Event Counter No. 3	5837	Event Counter No. 58	5892	Event Counter No. 113
5783	Event Counter No. 4	5838	Event Counter No. 59	5893	Event Counter No. 114
5784	Event Counter No. 5	5839	Event Counter No. 60	5894	Event Counter No. 115
5785	Event Counter No. 6	5840	Event Counter No. 61	5895	Event Counter No. 116
5786	Event Counter No. 7	5841	Event Counter No. 62	5896	Event Counter No. 117
5787	Event Counter No. 8	5842	Event Counter No. 63	5897	Event Counter No. 118
5788	Event Counter No. 9	5843	Event Counter No. 64	5898	Event Counter No. 119
5789	Event Counter No. 10	5844	Event Counter No. 65	5899	Event Counter No. 120
5790	Event Counter No. 11	5845	Event Counter No. 66		
5791	Event Counter No. 12	5846	Event Counter No. 67		
5792	Event Counter No. 13	5847	Event Counter No. 68		
5793	Event Counter No. 14	5848	Event Counter No. 69		
5794	Event Counter No. 15	5849	Event Counter No. 70		
5795	Event Counter No. 16	5850	Event Counter No. 71		
5796	Event Counter No. 17	5851	Event Counter No. 72		
5797	Event Counter No. 18	5852	Event Counter No. 73		
5798	Event Counter No. 19	5853	Event Counter No. 74		
5799	Event Counter No. 20	5854	Event Counter No. 75		
5800	Event Counter No. 21	5855	Event Counter No. 76		
5801	Event Counter No. 22	5856	Event Counter No. 77		
5802	Event Counter No. 23	5857	Event Counter No. 78		
5803	Event Counter No. 23	5858	Event Counter No. 79		
5804	Event Counter No. 25	5859	Event Counter No. 80		
5805	Event Counter No. 26	5860	Event Counter No. 81		
5806	Event Counter No. 27	5861	Event Counter No. 82		
5807	Event Counter No. 28	5862	Event Counter No. 83		
5808	Event Counter No. 29	5863	Event Counter No. 84		
5809	Event Counter No. 30	5864	Event Counter No. 85		
5810	Event Counter No. 31	5865	Event Counter No. 86		
5811	Event Counter No. 32	5866	Event Counter No. 87		
5812	Event Counter No. 33	5867	Event Counter No. 88		
5813	Event Counter No. 34	5868	Event Counter No. 89		
5814	Event Counter No. 35	5869	Event Counter No. 90		
5815	Event Counter No. 36	5870	Event Counter No. 91		
5816	Event Counter No. 37	5871	Event Counter No. 92		
5817	Event Counter No. 38	5872	Event Counter No. 93		
5818	Event Counter No. 39	5873	Event Counter No. 94		
5819	Event Counter No. 40	5874	Event Counter No. 95		
5820	Event Counter No. 41	5875	Event Counter No. 96		

**SPECTRAL COMPONENTS**

<u>Reg. No.</u>	<u>Description</u>	<u>Units</u>	<u>Range</u>
<b>Phase A Voltage</b>			
<i>Note: Registers 4000–4447 apply to circuit monitor models CM-2350 and higher only.</i>			
4000–4001	Reserved		
4002	H1 magnitude as a percent of H1 magnitude	% in 100ths	10000
4003	H1 Va angle defined as 0.0 for H1 reference	In 10ths of degrees	0
4004	H2 magnitude as a percent of H1 magnitude	% in 100ths	0 to 32767
4005	H2 Va angle defined as 0.0 for H2 reference	In 10ths of degrees	0
4006	H3 magnitude as a percent of H1 magnitude	% in 100ths	0 to 32767
4007	H3 Va angle defined as 0.0 for H3 reference	In 10ths of degrees	0
4008	H4 magnitude as a percent of H1 magnitude	% in 100ths	0 to 32767
4009	H4 Va angle defined as 0.0 for H4 reference	In 10ths of degrees	0
4010	H5 magnitude as a percent of H1 magnitude	% in 100ths	0 to 32767
4011	H5 Va angle defined as 0.0 for H5 reference	In 10ths of degrees	0
4012	H6 magnitude as a percent of H1 magnitude	% in 100ths	0 to 32767
4013	H6 Va angle defined as 0.0 for H6 reference	In 10ths of degrees	0
4014	H7 magnitude as a percent of H1 magnitude	% in 100ths	0 to 32767
4015	H7 Va angle defined as 0.0 for H7 reference	tenths of degree	0
4016	H8 magnitude as a percent of H1 magnitude	% in 100ths	0 to 32767
4017	H8 Va angle defined as 0.0 for H8 reference	In 10ths of degrees	0
4018	H9 magnitude as a percent of H1 magnitude	% in 100ths	0 to 32767
4019	H9 Va angle defined as 0.0 for H9 reference	In 10ths of degrees	0
4020	H10 magnitude as a percent of H1 magnitude	% in 100ths	0 to 32767
4021	H10 Va angle defined as 0.0 for H10 reference	In 10ths of degrees	0
4022	H11 magnitude as a percent of H1 magnitude	% in 100ths	0 to 32767
4023	H11 Va angle defined as 0.0 for H11 reference	In 10ths of degrees	0
4024	H12 magnitude as a percent of H1 magnitude	% in 100ths	0 to 32767
4025	H12 Va angle defined as 0.0 for H12 reference	In 10ths of degrees	0
4026	H13 magnitude as a percent of H1 magnitude	% in 100ths	0 to 32767
4027	H13 Va angle defined as 0.0 for H13 reference	In 10ths of degrees	0
4028	H14 magnitude as a percent of H1 magnitude	% in 100ths	0 to 32767
4029	H14 Va angle defined as 0.0 for H14 reference	In 10ths of degrees	0
4030	H15 magnitude as a percent of H1 magnitude	% in 100ths	0 to 32767
4031	H15 Va angle defined as 0.0 for H15 reference	In 10ths of degrees	0
4032	H16 magnitude as a percent of H1 magnitude	% in 100ths	0 to 32767
4033	H16 Va angle defined as 0.0 for H16 reference	In 10ths of degrees	0
4034	H17 magnitude as a percent of H1 magnitude	% in 100ths	0 to 32767
4035	H17 Va angle defined as 0.0 for H17 reference	In 10ths of degrees	0
4036	H18 magnitude as a percent of H1 magnitude	% in 100ths	0 to 32767
4037	H18 Va angle defined as 0.0 for H18 reference	In 10ths of degrees	0
4038	H19 magnitude as a percent of H1 magnitude	% in 100ths	0 to 32767
4039	H19 Va angle defined as 0.0 for H19 reference	In 10ths of degrees	0
4040	H20 magnitude as a percent of H1 magnitude	% in 100ths	0 to 32767
4041	H20 Va angle defined as 0.0 for H20 reference	In 10ths of degrees	0
4042	H21 magnitude as a percent of H1 magnitude	% in 100ths	0 to 32767
4043	H21 Va angle defined as 0.0 for H21 reference	In 10ths of degrees	0
4044	H22 magnitude as a percent of H1 magnitude	% in 100ths	0 to 32767
4045	H22 Va angle defined as 0.0 for H22 reference	In 10ths of degrees	0
4046	H23 magnitude as a percent of H1 magnitude	% in 100ths	0 to 32767
4047	H23 Va angle defined as 0.0 for H23 reference	In 10ths of degrees	0
4048	H24 magnitude as a percent of H1 magnitude	% in 100ths	0 to 32767
4049	H24 Va angle defined as 0.0 for H24 reference	In 10ths of degrees	0
4050	H25 magnitude as a percent of H1 magnitude	% in 100ths	0 to 32767
4051	H25 Va angle defined as 0.0 for H25 reference	In 10ths of degrees	0
4052	H26 magnitude as a percent of H1 magnitude	% in 100ths	0 to 32767

<u>Reg. No.</u>	<u>Description</u>	<u>Units</u>	<u>Range</u>
4053	H26 Va angle defined as 0.0 for H26 reference	In 10ths of degrees	0
4054	H27 magnitude as a percent of H1 magnitude	% in 100ths	0 to 32767
4055	H27 Va angle defined as 0.0 for H27 reference	In 10ths of degrees	0
4056	H28 magnitude as a percent of H1 magnitude	% in 100ths	0 to 32767
4057	H28 Va angle defined as 0.0 for H28 reference	In 10ths of degrees	0
4058	H29 magnitude as a percent of H1 magnitude	% in 100ths	0 to 32767
4059	H29 Va angle defined as 0.0 for H29 reference	In 10ths of degrees	0
4060	H30 magnitude as a percent of H1 magnitude	% in 100ths	0 to 32767
4061	H30 Va angle defined as 0.0 for H30 reference	In 10ths of degrees	0
4062	H31 magnitude as a percent of H1 magnitude	% in 100ths	0 to 32767
4063	H31 Va angle defined as 0.0 for H31 reference	In 10ths of degrees	0

**Phase A Current**

4064–4065	Reserved		
4066	H1 magnitude as a percent of H1 magnitude	% in 100ths	10000
4067	H1 angle with reference to H1 Va angle	In 10ths of degrees	0
4068	H2 magnitude as a percent of H1 magnitude	% in 100ths	0 to 32767
4069	H2 angle with reference to H2 Va angle	In 10ths of degrees	0
4070	H3 magnitude as a percent of H1 magnitude	% in 100ths	0 to 32767
4071	H3 angle with reference to H3 Va angle	In 10ths of degrees	0
4072	H4 magnitude as a percent of H1 magnitude	% in 100ths	0 to 32767
4073	H4 angle with reference to H4 Va angle	In 10ths of degrees	0
4074	H5 magnitude as a percent of H1 magnitude	% in 100ths	0 to 32767
4075	H5 angle with reference to H5 Va angle	In 10ths of degrees	0
4076	H6 magnitude as a percent of H1 magnitude	% in 100ths	0 to 32767
4077	H6 angle with reference to H6 Va angle	In 10ths of degrees	0
4078	H7 magnitude as a percent of H1 magnitude	% in 100ths	0 to 32767
4079	H7 angle with reference to H7 Va angle	In 10ths of degrees	0
4080	H8 magnitude as a percent of H1 magnitude	% in 100ths	0 to 32767
4081	H8 angle with reference to H8 Va angle	In 10ths of degrees	0
4082	H9 magnitude as a percent of H1 magnitude	% in 100ths	0 to 32767
4083	H9 angle with reference to H9 Va angle	In 10ths of degrees	0
4084	H10 magnitude as a percent of H1 magnitude	% in 100ths	0 to 32767
4085	H10 angle with reference to H10 Va angle	In 10ths of degrees	0
4086	H11 magnitude as a percent of H1 magnitude	% in 100ths	0 to 32767
4087	H11 angle with reference to H11 Va angle	In 10ths of degrees	0
4088	H12 magnitude as a percent of H1 magnitude	% in 100ths	0 to 32767
4089	H12 angle with reference to H12 Va angle	In 10ths of degrees	0
4090	H13 magnitude as a percent of H1 magnitude	% in 100ths	0 to 32767
4091	H13 angle with reference to H13 Va angle	In 10ths of degrees	0
4092	H14 magnitude as a percent of H1 magnitude	% in 100ths	0 to 32767
4093	H14 angle with reference to H14 Va angle	In 10ths of degrees	0
4094	H15 magnitude as a percent of H1 magnitude	% in 100ths	0 to 32767
4095	H15 angle with reference to H15 Va angle	In 10ths of degrees	0
4096	H16 magnitude as a percent of H1 magnitude	% in 100ths	0 to 32767
4097	H16 angle with reference to H16 Va angle	In 10ths of degrees	0
4098	H17 magnitude as a percent of H1 magnitude	% in 100ths	0 to 32767
4099	H17 angle with reference to H17 Va angle	In 10ths of degrees	0
4100	H18 magnitude as a percent of H1 magnitude	% in 100ths	0 to 32767
4101	H18 angle with reference to H18 Va angle	In 10ths of degrees	0
4102	H19 magnitude as a percent of H1 magnitude	% in 100ths	0 to 32767
4103	H19 angle with reference to H19 Va angle	In 10ths of degrees	0
4104	H20 magnitude as a percent of H1 magnitude	% in 100ths	0 to 32767
4105	H20 angle with reference to H20 Va angle	In 10ths of degrees	0
4106	H21 magnitude as a percent of H1 magnitude	% in 100ths	0 to 32767
4107	H21 angle with reference to H21 Va angle	In 10ths of degrees	0

<u>Reg. No.</u>	<u>Description</u>	<u>Units</u>	<u>Range</u>
4108	H22 magnitude as a percent of H1 magnitude	% in 100ths	0 to 32767
4109	H22 angle with reference to H22 Va angle	In 10ths of degrees	0
4110	H23 magnitude as a percent of H1 magnitude	% in 100ths	0 to 32767
4111	H23 angle with reference to H23 Va angle	In 10ths of degrees	0
4112	H24 magnitude as a percent of H1 magnitude	% in 100ths	0 to 32767
4113	H24 angle with reference to H24 Va angle	In 10ths of degrees	0
4114	H25 magnitude as a percent of H1 magnitude	% in 100ths	0 to 32767
4115	H25 angle with reference to H25 Va angle	In 10ths of degrees	0
4116	H26 magnitude as a percent of H1 magnitude	% in 100ths	0 to 32767
4117	H26 angle with reference to H26 Va angle	In 10ths of degrees	0
4118	H27 magnitude as a percent of H1 magnitude	% in 100ths	0 to 32767
4119	H27 angle with reference to H27 Va angle	In 10ths of degrees	0
4120	H28 magnitude as a percent of H1 magnitude	% in 100ths	0 to 32767
4121	H28 angle with reference to H28 Va angle	In 10ths of degrees	0
4122	H29 magnitude as a percent of H1 magnitude	% in 100ths	0 to 32767
4123	H29 angle with reference to H29 Va angle	In 10ths of degrees	0
4124	H30 magnitude as a percent of H1 magnitude	% in 100ths	0 to 32767
4125	H30 angle with reference to H30 Va angle	In 10ths of degrees	0
4126	H31 magnitude as a percent of H1 magnitude	% in 100ths	0 to 32767
4127	H31 angle with reference to H31 Va angle	In 10ths of degrees	0

**Phase B Voltage**

4128–4129	Reserved		
4130	H1 magnitude as a percent of H1 magnitude	% in 100ths	10000
4131	H1 angle with reference to H1 Va angle	In 10ths of degrees	0
4132	H2 magnitude as a percent of H1 magnitude	% in 100ths	0 to 32767
4133	H2 angle with reference to H2 Va angle	In 10ths of degrees	0
4134	H3 magnitude as a percent of H1 magnitude	% in 100ths	0 to 32767
4135	H3 angle with reference to H3 Va angle	In 10ths of degrees	0
4136	H4 magnitude as a percent of H1 magnitude	% in 100ths	0 to 32767
4137	H4 angle with reference to H4 Va angle	In 10ths of degrees	0
4138	H5 magnitude as a percent of H1 magnitude	% in 100ths	0 to 32767
4139	H5 angle with reference to H5 Va angle	In 10ths of degrees	0
4140	H6 magnitude as a percent of H1 magnitude	% in 100ths	0 to 32767
4141	H6 angle with reference to H6 Va angle	In 10ths of degrees	0
4142	H7 magnitude as a percent of H1 magnitude	% in 100ths	0 to 32767
4143	H7 angle with reference to H7 Va angle	In 10ths of degrees	0
4144	H8 magnitude as a percent of H1 magnitude	% in 100ths	0 to 32767
4145	H8 angle with reference to H8 Va angle	In 10ths of degrees	0
4146	H9 magnitude as a percent of H1 magnitude	% in 100ths	0 to 32767
4147	H9 angle with reference to H9 Va angle	In 10ths of degrees	0
4148	H10 magnitude as a percent of H1 magnitude	% in 100ths	0 to 32767
4149	H10 angle with reference to H10 Va angle	In 10ths of degrees	0
4150	H11 magnitude as a percent of H1 magnitude	% in 100ths	0 to 32767
4151	H11 angle with reference to H11 Va angle	In 10ths of degrees	0
4152	H12 magnitude as a percent of H1 magnitude	% in 100ths	0 to 32767
4153	H12 angle with reference to H12 Va angle	In 10ths of degrees	0
4154	H13 magnitude as a percent of H1 magnitude	% in 100ths	0 to 32767
4155	H13 angle with reference to H13 Va angle	In 10ths of degrees	0
4156	H14 magnitude as a percent of H1 magnitude	% in 100ths	0 to 32767
4157	H14 angle with reference to H14 Va angle	In 10ths of degrees	0
4158	H15 magnitude as a percent of H1 magnitude	% in 100ths	0 to 32767
4159	H15 angle with reference to H15 Va angle	In 10ths of degrees	0
4160	H16 magnitude as a percent of H1 magnitude	% in 100ths	0 to 32767
4161	H16 angle with reference to H16 Va angle	In 10ths of degrees	0
4162	H17 magnitude as a percent of H1 magnitude	% in 100ths	0 to 32767

<u>Reg. No.</u>	<u>Description</u>	<u>Units</u>	<u>Range</u>
4163	H17 angle with reference to H17 Va angle	In 10ths of degrees	0
4164	H18 magnitude as a percent of H1 magnitude	% in 100ths	0 to 32767
4165	H18 angle with reference to H18 Va angle	In 10ths of degrees	0
4166	H19 magnitude as a percent of H1 magnitude	% in 100ths	0 to 32767
4167	H19 angle with reference to H19 Va angle	In 10ths of degrees	0
4168	H20 magnitude as a percent of H1 magnitude	% in 100ths	0 to 32767
4169	H20 angle with reference to H20 Va angle	In 10ths of degrees	0
4170	H21 magnitude as a percent of H1 magnitude	% in 100ths	0 to 32767
4171	H21 angle with reference to H21 Va angle	In 10ths of degrees	0
4172	H22 magnitude as a percent of H1 magnitude	% in 100ths	0 to 32767
4173	H22 angle with reference to H22 Va angle	In 10ths of degrees	0
4174	H23 magnitude as a percent of H1 magnitude	% in 100ths	0 to 32767
4175	H23 angle with reference to H23 Va angle	In 10ths of degrees	0
4176	H24 magnitude as a percent of H1 magnitude	% in 100ths	0 to 32767
4177	H24 angle with reference to H24 Va angle	In 10ths of degrees	0
4178	H25 magnitude as a percent of H1 magnitude	% in 100ths	0 to 32767
4179	H25 angle with reference to H25 Va angle	In 10ths of degrees	0
4180	H26 magnitude as a percent of H1 magnitude	% in 100ths	0 to 32767
4181	H26 angle with reference to H26 Va angle	In 10ths of degrees	0
4182	H27 magnitude as a percent of H1 magnitude	% in 100ths	0 to 32767
4183	H27 angle with reference to H27 Va angle	In 10ths of degrees	0
4184	H28 magnitude as a percent of H1 magnitude	% in 100ths	0 to 32767
4185	H28 angle with reference to H28 Va angle	In 10ths of degrees	0
4186	H29 magnitude as a percent of H1 magnitude	% in 100ths	0 to 32767
4187	H29 angle with reference to H29 Va angle	In 10ths of degrees	0
4188	H30 magnitude as a percent of H1 magnitude	% in 100ths	0 to 32767
4189	H30 angle with reference to H30 Va angle	In 10ths of degrees	0
4190	H31 magnitude as a percent of H1 magnitude	% in 100ths	10000
4191	H31 angle with reference to H31 Va angle	In 10ths of degrees	0

**Phase B Current**

4192–4193	Reserved		
4194	H1 magnitude as a percent of H1 magnitude	% in 100ths	10000
4195	H1 angle with reference to H1 Va angle	In 10ths of degrees	0
4196	H2 magnitude as a percent of H1 magnitude	% in 100ths	0 to 32767
4197	H2 angle with reference to H2 Va angle	In 10ths of degrees	0
4198	H3 magnitude as a percent of H1 magnitude	% in 100ths	0 to 32767
4199	H3 angle with reference to H3 Va angle	In 10ths of degrees	0
4200	H4 magnitude as a percent of H1 magnitude	% in 100ths	0 to 32767
4201	H4 angle with reference to H4 Va angle	In 10ths of degrees	0
4202	H5 magnitude as a percent of H1 magnitude	% in 100ths	0 to 32767
4203	H5 angle with reference to H5 Va angle	In 10ths of degrees	0
4204	H6 magnitude as a percent of H1 magnitude	% in 100ths	0 to 32767
4205	H6 angle with reference to H6 Va angle	In 10ths of degrees	0
4206	H7 magnitude as a percent of H1 magnitude	% in 100ths	0 to 32767
4207	H7 angle with reference to H7 Va angle	In 10ths of degrees	0
4208	H8 magnitude as a percent of H1 magnitude	% in 100ths	0 to 32767
4209	H8 angle with reference to H8 Va angle	In 10ths of degrees	0
4210	H9 magnitude as a percent of H1 magnitude	% in 100ths	0 to 32767
4211	H9 angle with reference to H9 Va angle	In 10ths of degrees	0
4212	H10 magnitude as a percent of H1 magnitude	% in 100ths	0 to 32767
4213	H10 angle with reference to H10 Va angle	In 10ths of degrees	0
4214	H11 magnitude as a percent of H1 magnitude	% in 100ths	0 to 32767
4215	H11 angle with reference to H11 Va angle	In 10ths of degrees	0
4216	H12 magnitude as a percent of H1 magnitude	% in 100ths	0 to 32767
4217	H12 angle with reference to H12 Va angle	In 10ths of degrees	0

<u>Reg. No.</u>	<u>Description</u>	<u>Units</u>	<u>Range</u>
4218	H13 magnitude as a percent of H11 magnitude	% in 100ths	0 to 32767
4219	H13 angle with reference to H13 Va angle	In 10ths of degrees	0
4220	H14 magnitude as a percent of H1 magnitude	% in 100ths	0 to 32767
4221	H14 angle with reference to H14 Va angle	In 10ths of degrees	0
4222	H15 magnitude as a percent of H1 magnitude	% in 100ths	0 to 32767
4223	H15 angle with reference to H15 Va angle	In 10ths of degrees	0
4224	H16 magnitude as a percent of H1 magnitude	% in 100ths	0 to 32767
4225	H16 angle with reference to H16 Va angle	In 10ths of degrees	0
4226	H17 magnitude as a percent of H1 magnitude	% in 100ths	0 to 32767
4227	H17 angle with reference to H17 Va angle	In 10ths of degrees	0
4228	H18 magnitude as a percent of H1 magnitude	% in 100ths	0 to 32767
4229	H18 angle with reference to H18 Va angle	In 10ths of degrees	0
4230	H19 magnitude as a percent of H1 magnitude	% in 100ths	0 to 32767
4231	H19 angle with reference to H19 Va angle	In 10ths of degrees	0
4232	H20 magnitude as a percent of H1 magnitude	% in 100ths	0 to 32767
4233	H20 angle with reference to H20 Va angle	In 10ths of degrees	0
4234	H21 magnitude as a percent of H1 magnitude	% in 100ths	0 to 32767
4235	H21 angle with reference to H21 Va angle	In 10ths of degrees	0
4236	H22 magnitude as a percent of H1 magnitude	% in 100ths	0 to 32767
4237	H22 angle with reference to H22 Va angle	In 10ths of degrees	0
4238	H23 magnitude as a percent of H1 magnitude	% in 100ths	0 to 32767
4239	H23 angle with reference to H23 Va angle	In 10ths of degrees	0
4240	H24 magnitude as a percent of H1 magnitude	% in 100ths	0 to 32767
4241	H24 angle with reference to H24 Va angle	In 10ths of degrees	0
4242	H25 magnitude as a percent of H1 magnitude	% in 100ths	0 to 32767
4243	H25 angle with reference to H25 Va angle	In 10ths of degrees	0
4244	H26 magnitude as a percent of H1 magnitude	% in 100ths	0 to 32767
4245	H26 angle with reference to H26 Va angle	In 10ths of degrees	0
4246	H27 magnitude as a percent of H1 magnitude	% in 100ths	0 to 32767
4247	H27 angle with reference to H27 Va angle	In 10ths of degrees	0
4248	H28 magnitude as a percent of H1 magnitude	% in 100ths	0 to 32767
4249	H28 angle with reference to H28 Va angle	In 10ths of degrees	0
4250	H29 magnitude as a percent of H1 magnitude	% in 100ths	0 to 32767
4251	H29 angle with reference to H29 Va angle	In 10ths of degrees	0
4252	H30 magnitude as a percent of H1 magnitude	% in 100ths	0 to 32767
4253	H30 angle with reference to H30 Va angle	In 10ths of degrees	0
4254	H31 magnitude as a percent of H1 magnitude	% in 100ths	0 to 32767
4255	H31 angle with reference to H31 Va angle	In 10ths of degrees	0

**Phase C Voltage**

4256-4257	Reserved		
4258	H1 magnitude as a percent of H1 magnitude	% in 100ths	10000
4259	H1 angle with reference to H1 Va angle	In 10ths of degrees	0
4260	H2 magnitude as a percent of H1 magnitude	% in 100ths	0 to 32767
4261	H2 angle with reference to H2 Va angle	In 10ths of degrees	0
4262	H3 magnitude as a percent of H1 magnitude	% in 100ths	0 to 32767
4263	H3 angle with reference to H3 Va angle	In 10ths of degrees	0
4264	H4 magnitude as a percent of H1 magnitude	% in 100ths	0 to 32767
4265	H4 angle with reference to H4 Va angle	In 10ths of degrees	0
4266	H5 magnitude as a percent of H1 magnitude	% in 100ths	0 to 32767
4267	H5 angle with reference to H5 Va angle	In 10ths of degrees	0
4268	H6 magnitude as a percent of H1 magnitude	% in 100ths	0 to 32767
4299	H21 angle with reference to H21 Va angle	In 10ths of degrees	0
4300	H22 magnitude as a percent of H1 magnitude	% in 100ths	0 to 32767
4301	H22 angle with reference to H22 Va angle	In 10ths of degrees	0
4302	H23 magnitude as a percent of H1 magnitude	% in 100ths	0 to 32767

<b>Reg. No.</b>	<b>Description</b>	<b>Units</b>	<b>Range</b>
4303	H23 angle with reference to H23 Va angle	In 10ths of degrees	0
4304	H24 magnitude as a percent of H1 magnitude	% in 100ths	0 to 32767
4305	H24 angle with reference to H24 Va angle	In 10ths of degrees	0
4306	H25 magnitude as a percent of H1 magnitude	% in 100ths	0 to 32767
4307	H25 angle with reference to H25 Va angle	In 10ths of degrees	0
4308	H26 magnitude as a percent of H1 magnitude	% in 100ths	0 to 32767
4309	H26 angle with reference to H26 Va angle	In 10ths of degrees	0
4310	H27 magnitude as a percent of H1 magnitude	% in 100ths	0 to 32767
4311	H27 angle with reference to H27 Va angle	In 10ths of degrees	0
4312	H28 magnitude as a percent of H1 magnitude	% in 100ths	0 to 32767
4313	H28 angle with reference to H28 Va angle	In 10ths of degrees	0
4314	H29 magnitude as a percent of H1 magnitude	% in 100ths	0 to 32767
4315	H29 angle with reference to H29 Va angle	In 10ths of degrees	0
4316	H30 magnitude as a percent of H1 magnitude	% in 100ths	0 to 32767
4317	H30 angle with reference to H30 Va angle	In 10ths of degrees	0
4318	H31 magnitude as a percent of H1 magnitude	% in 100ths	0 to 32767
4319	H31 angle with reference to H31 Va angle	In 10ths of degrees	0
<b>Phase C Current</b>			
4320–4321	Reserved		
4322	H1 magnitude as a percent of H1 magnitude	% in 100ths	10000
4323	H1 angle with reference to H1 Va angle	In 10ths of degrees	0
4324	H2 magnitude as a percent of H1 magnitude	% in 100ths	0 to 32767
4325	H2 angle with reference to H2 Va angle	In 10ths of degrees	0
4326	H3 magnitude as a percent of H1 magnitude	% in 100ths	0 to 32767
4327	H3 angle with reference to H3 Va angle	In 10ths of degrees	0
4328	H4 magnitude as a percent of H1 magnitude	% in 100ths	0 to 32767
4329	H4 angle with reference to H4 Va angle	In 10ths of degrees	0
4330	H5 magnitude as a percent of H1 magnitude	% in 100ths	0 to 32767
4331	H5 angle with reference to H5 Va angle	In 10ths of degrees	0
4332	H6 magnitude as a percent of H1 magnitude	% in 100ths	0 to 32767
4333	H6 angle with reference to H6 Va angle	In 10ths of degrees	0
4334	H7 magnitude as a percent of H1 magnitude	% in 100ths	0 to 32767
4335	H7 angle with reference to H7 Va angle	In 10ths of degrees	0
4336	H8 magnitude as a percent of H1 magnitude	% in 100ths	0 to 32767
4337	H8 angle with reference to H8 Va angle	In 10ths of degrees	0
4338	H9 magnitude as a percent of H1 magnitude	% in 100ths	0 to 32767
4339	H9 angle with reference to H9 Va angle	In 10ths of degrees	0
4340	H10 magnitude as a percent of H1 magnitude	% in 100ths	0 to 32767
4341	H10 angle with reference to H10 Va angle	In 10ths of degrees	0
4342	H11 magnitude as a percent of H1 magnitude	% in 100ths	0 to 32767
4343	H11 angle with reference to H11 Va angle	In 10ths of degrees	0
4344	H12 magnitude as a percent of H1 magnitude	% in 100ths	0 to 32767
4345	H12 angle with reference to H12 Va angle	In 10ths of degrees	0
4346	H13 magnitude as a percent of H1 magnitude	% in 100ths	0 to 32767
4347	H13 angle with reference to H13 Va angle	In 10ths of degrees	0
4348	H14 magnitude as a percent of H1 magnitude	% in 100ths	0 to 32767
4349	H14 angle with reference to H14 Va angle	In 10ths of degrees	0
4350	H15 magnitude as a percent of H1 magnitude	% in 100ths	0 to 32767
4351	H15 angle with reference to H15 Va angle	In 10ths of degrees	0
4352	H16 magnitude as a percent of H1 magnitude	% in 100ths	0 to 32767
4353	H16 angle with reference to H16 Va angle	In 10ths of degrees	0
4354	H17 magnitude as a percent of H1 magnitude	% in 100ths	0 to 32767
4355	H17 angle with reference to H17 Va angle	In 10ths of degrees	0
4356	H18 magnitude as a percent of H1 magnitude	% in 100ths	0 to 32767
4357	H18 angle with reference to H18 Va angle	In 10ths of degrees	0

<u>Reg. No.</u>	<u>Description</u>	<u>Units</u>	<u>Range</u>
4358	H19 magnitude as a percent of H1 magnitude	% in 100ths	0 to 32767
4359	H19 angle with reference to H19 Va angle	In 10ths of degrees	0
4360	H20 magnitude as a percent of H1 magnitude	% in 100ths	0 to 32767
4361	H20 angle with reference to H20 Va angle	In 10ths of degrees	0
4362	H21 magnitude as a percent of H1 magnitude	% in 100ths	0 to 32767
4363	H21 angle with reference to H21 Va angle	In 10ths of degrees	0
4364	H22 magnitude as a percent of H1 magnitude	% in 100ths	0 to 32767
4365	H22 angle with reference to H22 Va angle	In 10ths of degrees	0
4366	H23 magnitude as a percent of H1 magnitude	% in 100ths	0 to 32767
4367	H23 angle with reference to H23 Va angle	In 10ths of degrees	0
4368	H24 magnitude as a percent of H1 magnitude	% in 100ths	0 to 32767
4369	H24 angle with reference to H24 Va angle	In 10ths of degrees	0
4370	H25 magnitude as a percent of H1 magnitude	% in 100ths	0 to 32767
4371	H25 angle with reference to H25 Va angle	In 10ths of degrees	0
4372	H26 magnitude as a percent of H1 magnitude	% in 100ths	0 to 32767
4373	H26 angle with reference to H26 Va angle	In 10ths of degrees	0
4374	H27 magnitude as a percent of H1 magnitude	% in 100ths	0 to 32767
4375	H27 angle with reference to H27 Va angle	In 10ths of degrees	0
4376	H28 magnitude as a percent of H1 magnitude	% in 100ths	0 to 32767
4377	H28 angle with reference to H28 Va angle	In 10ths of degrees	0
4378	H29 magnitude as a percent of H1 magnitude	% in 100ths	0 to 32767
4379	H29 angle with reference to H29 Va angle	In 10ths of degrees	0
4380	H30 magnitude as a percent of H1 magnitude	% in 100ths	0 to 32767
4381	H30 angle with reference to H30 Va angle	In 10ths of degrees	0
4382	H31 magnitude as a percent of H1 magnitude	% in 100ths	0 to 32767
4383	H31 angle with reference to H31 Va angle	In 10ths of degrees	0

**Neutral Current**

4384–4385	Reserved		
4386	H1 magnitude as a percent of H1 magnitude	% in 100ths	10000
4387	H1 angle with reference to H1 Va angle	In 10ths of degrees	0
4388	H2 magnitude as a percent of H1 magnitude	% in 100ths	0 to 32767
4389	H2 angle with reference to H2 Va angle	In 10ths of degrees	0
4390	H3 magnitude as a percent of H1 magnitude	% in 100ths	0 to 32767
4391	H3 angle with reference to H3 Va angle	In 10ths of degrees	0
4392	H4 magnitude as a percent of H1 magnitude	% in 100ths	0 to 32767
4393	H4 angle with reference to H4 Va angle	In 10ths of degrees	0
4394	H5 magnitude as a percent of H1 magnitude	% in 100ths	0 to 32767
4395	H5 angle with reference to H5 Va angle	In 10ths of degrees	0
4396	H6 magnitude as a percent of H1 magnitude	% in 100ths	0 to 32767
4397	H6 angle with reference to H6 Va angle	In 10ths of degrees	0
4398	H7 magnitude as a percent of H1 magnitude	% in 100ths	0 to 32767
4399	H7 angle with reference to H7 Va angle	In 10ths of degrees	0
4400	H8 magnitude as a percent of H1 magnitude	% in 100ths	0 to 32767
4401	H8 angle with reference to H8 Va angle	In 10ths of degrees	0
4402	H9 magnitude as a percent of H1 magnitude	% in 100ths	0 to 32767
4403	H9 angle with reference to H9 Va angle	In 10ths of degrees	0
4404	H10 magnitude as a percent of H1 magnitude	% in 100ths	0 to 32767
4405	H10 angle with reference to H10 Va angle	In 10ths of degrees	0
4406	H11 magnitude as a percent of H1 magnitude	% in 100ths	0 to 32767
4407	H11 angle with reference to H11 Va angle	In 10ths of degrees	0
4408	H12 magnitude as a percent of H1 magnitude	% in 100ths	0 to 32767
4409	H12 angle with reference to H12 Va angle	In 10ths of degrees	0
4410	H13 magnitude as a percent of H1 magnitude	% in 100ths	0 to 32767
4411	H13 angle with reference to H13 Va angle	In 10ths of degrees	0
4412	H14 magnitude as a percent of H1 magnitude	% in 100ths	0 to 32767



<u>Reg. No.</u>	<u>Description</u>	<u>Units</u>	<u>Range</u>
4413	H14 angle with reference to H14 Va angle	In 10ths of degrees	0
4414	H15 magnitude as a percent of H1 magnitude	% in 100ths	0 to 32767
4415	H15 angle with reference to H15 Va angle	In 10ths of degrees	0
4416	H16 magnitude as a percent of H1 magnitude	% in 100ths	0 to 32767
4417	H16 angle with reference to H16 Va angle	In 10ths of degrees	0
4418	H17 magnitude as a percent of H1 magnitude	% in 100ths	0 to 32767
4419	H17 angle with reference to H17 Va angle	In 10ths of degrees	0
4420	H18 magnitude as a percent of H1 magnitude	% in 100ths	0 to 32767
4421	H18 angle with reference to H18 Va angle	In 10ths of degrees	0
4422	H19 magnitude as a percent of H1 magnitude	% in 100ths	0 to 32767
4423	H19 angle with reference to H19 Va angle	In 10ths of degrees	0
4424	H20 magnitude as a percent of H1 magnitude	% in 100ths	0 to 32767
4425	H20 angle with reference to H20 Va angle	In 10ths of degrees	0
4426	H21 magnitude as a percent of H1 magnitude	% in 100ths	0 to 32767
4427	H21 angle with reference to H21 Va angle	In 10ths of degrees	0
4428	H22 magnitude as a percent of H1 magnitude	% in 100ths	0 to 32767
4429	H22 angle with reference to H22 Va angle	In 10ths of degrees	0
4430	H23 magnitude as a percent of H1 magnitude	% in 100ths	0 to 32767
4431	H23 angle with reference to H23 Va angle	In 10ths of degrees	0
4432	H24 magnitude as a percent of H1 magnitude	% in 100ths	0 to 32767
4433	H24 angle with reference to H24 Va angle	In 10ths of degrees	0
4434	H25 magnitude as a percent of H1 magnitude	% in 100ths	0 to 32767
4435	H25 angle with reference to H25 Va angle	In 10ths of degrees	0
4436	H26 magnitude as a percent of H1 magnitude	% in 100ths	0 to 32767
4437	H26 angle with reference to H26 Va angle	In 10ths of degrees	0
4438	H27 magnitude as a percent of H1 magnitude	% in 100ths	0 to 32767
4439	H27 angle with reference to H27 Va angle	In 10ths of degrees	0
4440	H28 magnitude as a percent of H1 magnitude	% in 100ths	0 to 32767
4441	H28 angle with reference to H28 Va angle	In 10ths of degrees	0
4442	H29 magnitude as a percent of H1 magnitude	% in 100ths	0 to 32767
4443	H29 angle with reference to H29 Va angle	In 10ths of degrees	0
4444	H30 magnitude as a percent of H1 magnitude	% in 100ths	0 to 32767
4445	H30 angle with reference to H30 Va angle	In 10ths of degrees	0
4446	H311 magnitude as a percent of H1 magnitude	% in 100ths	0 to 32767
4447	H311 angle with reference to H31 Va angle	In 10ths of degrees	0



## APPENDIX C—CALCULATING LOG FILE SIZES

This appendix tells how to calculate the approximate size of log files. To see if the log files you've set up will fit in the available logging memory, calculate the size of each event log, data log, waveform capture log, and extended event capture log using the worksheet on the following page. Then sum all log files to find the total space required. The total space required must be smaller than the numbers listed below:\*

- **CM-2150 and CM-2250 (standard, -512k, -1024k)**—Sum of event log file and all data log files for **standard, -512k, and -1024k** must be smaller than 51,200, 313,344, and 575,488, respectively.
- **CM-2350 and CM-2450 (standard, -512k, -1024k)**—Sum of event log file, waveform capture log file, extended event capture, and all data log files for **standard, -512k, and -1024k** must be smaller than 51,200, 313,344, and 575,488, respectively.
- **CM-2452**—Sum of event log file, waveform capture log file, extended event capture, and all data log files must be smaller than 182,272.

*Note: The log file worksheet will provide a close approximation of the required memory allocation. The memory allocation worksheet results may differ slightly from actual memory allocation requirements.*

\* Applies to circuit monitor series G4 or later

Data log 1	_____
Data log 2	_____
Data log 3	_____
Data log 4	_____
Data log 5	_____
Data log 6	_____
Data log 7	_____
Data log 8	_____
Data log 9	_____
Data log 10	_____
Data log 11	_____
Data log 12	_____
Data log 13	_____
Data log 14	_____
<b>TOTAL</b>	<input type="text"/>

**Calculate the Size of the Event Log File**

1. Multiply the maximum number of events by 8. 1. \_\_\_\_\_

**Calculate the Sizes of the Data Log Files**

*Repeat steps 2–7 for each data log file.*

2. Multiply the number of cumulative energy readings by 4. 2. \_\_\_\_\_
3. Multiply the number of incremental energy readings by 3. 3. \_\_\_\_\_
4. Enter the number of non-energy meter readings. 4. \_\_\_\_\_
5. Add lines 2, 3, and 4. 5. \_\_\_\_\_
6. Add 3 to the value on line 5. (For date/time of each entry.) 6. \_\_\_\_\_
7. Multiply line 6 by the maximum number of records in the data log file. Enter the result in the data log box to the left.
8. Repeat steps 2–7 for each data log file.
9. Total all data log files and enter the result here. 9. \_\_\_\_\_

**Calculate the Size of the Waveform Capture Log File**

10. *For CM-2350s and higher only*, multiply the maximum number of waveform captures by 2,560. For CM-2150s and CM-2250s enter zero here.<sup>①</sup> 10. \_\_\_\_\_

**Calculate the Size of the Extended Event Capture Log File**

11. *For CM-2350s and higher only*, for every 12 cycles, multiply by 6,400. (Example for 60 cycles: 5 x 6,400= 32,000.) For CM-2150s and CM-2250s enter zero here.<sup>①</sup> 11. \_\_\_\_\_

**Total All Log Files**

12. Add lines 1, 9, 10, and 11. For standard CM-2150s, CM-2250s, CM-2350s, and CM-2450s, the total cannot exceed 51,200. For CM-2452s, the total cannot exceed 182,272. For models with the -512k option, the total cannot exceed 313,344. For models with the -1024k option, the total cannot exceed 575,488. 12. \_\_\_\_\_

<sup>①</sup> The CM-2150 does not provide waveform capture. The CM-2250 can store one 4-cycle waveform capture and one 12-cycle event capture, but these are stored in separate memory locations and do not affect the amount of memory available for event and data logging.

## APPENDIX D—ALARM SETUP INFORMATION

The circuit monitor is designed to handle a wide range of metering requirements. To handle very large and very small metering values, the circuit monitor uses scale factors to act as multipliers. These scale factors range from .001 up to 1000 and are expressed at powers of 10—for example,  $0.001 = 10^{-3}$ . These scale factors are necessary because the circuit monitor stores data in registers which are limited to integer to values between -32767 and +32767. When a value is either larger than 32767, or is a non-integer, it is expressed as an integer in the range of  $\pm 32767$  associated with a multiplier in the range of  $10^{-3}$  to  $10^3$ . For more information on scale factors see **Setting Scale Factors for Extended Metering Ranges** in **Chapter 9**.

When POWERLOGIC application software is used to set up alarms, it automatically handles the scaling of pickup and dropout setpoints.

When alarm setup is performed from the circuit monitor's front panel, the user must:

- determine how the corresponding metering value is scaled, and
- take the scale factor into account when entering alarm pickup and dropout settings.

Pickup and dropout settings must be integer values in the range of -32,767 to +32,767. For example, to set up an under voltage alarm for a 138 kV nominal system the user must decide upon a setpoint value, and then convert it into an integer between -32,767 and +32,767. If the under voltage setpoint were 125,000 V, this would typically be converted to  $12500 \times 10$  and entered as a setpoint of 12500.

### SCALING ALARM SETPOINTS

This section is for users who do not have POWERLOGIC software and must set up alarms from the circuit monitor front panel. It tells how to properly scale alarm setpoints.

The circuit monitor is equipped with a 6-digit LED display and a two LED's to indicate "Kilo" or "Mega" units, when applicable. When determining the proper scaling of an alarm setpoint first view the corresponding metering value. For example, for an "Over Current Phase A" alarm, view the Phase A Current. Observe the location of the decimal point in the displayed value and determine if either the "Kilo" or "Mega" light is turned on. This reading can be used to determine the scaling required for alarm setpoints.

The location of the decimal point in the displayed quantity indicates the resolution that is available on this metering quantity. There can be up to 3 digits to the right of the decimal point, indicating whether the quantity is stored in a register as thousandths, hundredths, tenths, or units. The "Kilo" or "Mega" LED indicates the engineering units—Kilowatts or Megawatts—that are applied to the quantity. The alarm setpoint value must use the same resolution as shown in the display.

For example, consider a power factor alarm. If the 3-phase average power factor is 1.000—meaning that the power factor is stored in thousandths—enter the alarm setpoints as integer values in thousandths. Therefore, to define a power factor setpoint of 0.85 lagging, enter -850 (the “-” sign indicates lag).

For another example, consider a “Phase A-B Undervoltage” alarm. If the  $V_{A-B}$  reading is displayed as 138.00 with the Kilo LED turned on, then enter the setpoints in hundredths of kilovolts. Therefore, to define a setpoint of 125,000 volts, enter 12,500 (hundredths of kV). To arrive at this value, first convert 125,000 volts to 125.00 kilovolts; then multiply by 100.

## ALARM CONDITIONS AND ALARM NUMBERS

This section lists the circuit monitor’s predefined alarm conditions. For each alarm condition, the following information is provided.

<b>Alarm No.</b>	A code number used to refer to individual alarms
<b>Alarm Description</b>	A brief description of the alarm condition
<b>Test Register</b>	The register number that contains the value (where applicable) that is used as the basis for a comparison to alarm pickup and dropout settings.
<b>Units</b>	The units that apply to the pickup and dropout settings.
<b>Scale Group</b>	The Scale Group that applies to the test register’s metering value (A–F). For a description of Scale Groups, see <b>Setting Scale Factors for Extended Metering Ranges</b> in Chapter 9.
<b>Alarm Type</b>	A reference to a definition providing details on the operation and configuration of the alarm. For a description of alarm types, refer to <b>Alarm Type Definitions</b> , page 121.

<u>Alarm No.</u>	<u>Alarm Description</u>	<u>Test Register</u>	<u>Units</u>	<u>Scale Group</u>	<u>Alarm Type</u>
01	Over Current Phase A	1003	Amps	A	A
02	Over Current Phase B	1004	Amps	A	A
03	Over Current Phase C	1005	Amps	A	A
04	Over Current Neutral	1006	Amps	B	A
05	Over Current Ground	1007	Amps	C	A
06	Under Current Phase A	1003	Amps	A	B
07	Under Current Phase B	1004	Amps	A	B
08	Under Current Phase C	1005	Amps	A	B
09	Current Unbalance Phase A	1010	Tenths %		A
10	Current Unbalance Phase B	1011	Tenths %		A
11	Current Unbalance Phase C	1012	Tenths %		A
12	Phase Loss, Current	2122	Tenths %		C
13	Over Voltage Phase A	1018	Volts	D	A
14	Over Voltage Phase B	1019	Volts	D	A
15	Over Voltage Phase C	1020	Volts	D	A

<u>Alarm No.</u>	<u>Alarm Description</u>	<u>Test Register</u>	<u>Units</u>	<u>Scale Group</u>	<u>Alarm Type</u>
16	Over Voltage Phase A-B	1014	Volts	D	A
17	Over Voltage Phase B-C	1015	Volts	D	A
18	Over Voltage Phase C-A	1016	Volts	D	A
19	Under Voltage Phase A	1018	Volts	B	B
20	Under Voltage Phase B	1019	Volts	B	B
21	Under Voltage Phase C	1020	Volts	B	B
22	Under Voltage Phase A-B	1014	Volts	B	B
23	Under Voltage Phase B-C	1015	Volts	B	B
24	Under Voltage Phase C-A	1016	Volts	B	B
25	Voltage Unbalance A	1026	Tenths %		A
26	Voltage Unbalance B	1027	Tenths %		A
27	Voltage Unbalance C	1028	Tenths %		A
28	Voltage Unbalance A-B	1022	Tenths %		A
29	Voltage Unbalance B-C	1023	Tenths %		A
30	Voltage Unbalance C-A	1024	Tenths %		A
31	Voltage Loss (Loss of A, B, or C, but not all)	2122	Volts	D	D
32	Over kVA 3-Phase Total	1050	kVA	E	A
33	Over KW Into the Load 3-Phase Total	1042	KW	E	A
34	Over KW Out of the Load 3-Phase Total	1042	KW	E	A
35	Over kVAR Into the Load 3-Phase Total	1046	kVAR	E	A
36	Over kVAR Out of the Load 3-Phase Total	1046	kVAR	E	A
37	Over Current Demand Phase A	1701	Amps	A	A
38	Over Current Demand Phase B	1702	Amps	A	A
39	Over Current Demand Phase C	1703	Amps	A	A
40	Over Current Demand 3-phase Total	1700	Amps	A	A
41	Over Frequency	1001	Hundredths of Hertz	F	A
42	Under Frequency	1001	Hundredths of Hertz	F	B
43	Lagging True Power Factor	1034	Thousandths		E
44	Leading True Power Factor	1034	Thousandths		F
45	Lagging Displacement Power Factor	1038	Thousandths		E
46	Leading Displacement Power Factor	1038	Thousandths		F
47	Suspended Sag/Swell				T
48	Reserved				
49	Over Value THD Current Phase A	1051	Tenths %		A
50	Over Value THD Current Phase B	1052	Tenths %		A
51	Over Value THD Current Phase C	1053	Tenths %		A
52	Over Value THD Voltage Phase A-N	1055	Tenths %		A
53	Over Value THD Voltage Phase B-N	1056	Tenths %		A
54	Over Value THD Voltage Phase C-N	1057	Tenths %		A
55	Over Value THD Voltage Phase A-B	1058	Tenths %		A
56	Over Value THD Voltage Phase B-C	1059	Tenths %		A
57	Over Value THD Voltage Phase C-A	1060	Tenths %		A
58	Over K-Factor Phase A	1071	Tenths %		A
59	Over K-Factor Phase B	1072	Tenths %		A
60	Over K-Factor Phase C	1073	Tenths %		A
61	Over Predicted kVA Demand	1748	kVA	E	G
62	Over Predicted KW Demand	1746	kW	E	G
63	Over Predicted kVAR Demand	1747	kVAR	E	G
64	Over kVA Demand Level 1	1733	kVA	E	G
65	Over kVA Demand Level 2	1733	kVA	E	G
66	Over kVA Demand Level 3	1733	kVA	E	G
67	Over kW Demand Level 1	1731	kW	E	G

<u>Alarm No.</u>	<u>Alarm Description</u>	<u>Test Register</u>	<u>Units</u>	<u>Scale Group</u>	<u>Alarm Type</u>
68	Over KW Demand Level 2	1731	kW	E	G
69	Over KW Demand Level 3	1731	kW	E	G
70	Over kVAR Demand	1732	kVAR	E	G
71	Over Lagging 3-phase Avg. Power Factor	1730	Thousandths		H
72	Under 3-Phase Total Real Power	1042	kW	E	I
73	Over Reverse 3-Phase Power	1042	kW	E	J
74	Phase Reversal	1117			K
75	Status Input 1 Transition from Off to On				L
76	Status Input 2 Transition from Off to On				L
77	Status Input 3 Transition from Off to On				L
78	Status Input 4 Transition from Off to On				L
79	Status Input 5 Transition from Off to On				L
80	Status Input 6 Transition from Off to On				L
81	Status Input 7 Transition from Off to On				L
82	Status Input 8 Transition from Off to On				L
83	Status Input 1 Transition from On to Off				M
84	Status Input 2 Transition from On to Off				M
85	Status Input 3 Transition from On to Off				M
86	Status Input 4 Transition from On to Off				M
87	Status Input 5 Transition from On to Off				M
88	Status Input 6 Transition from On to Off				M
89	Status Input 7 Transition from On to Off				M
90	Status Input 8 Transition from On to Off				M
91-98	Reserved				
99	End of Incremental Energy Interval				N
100	Power-Up/Reset				O
101	End of Demand Interval				N
102	End of Update Cycle				N
103	Over Analog Input Channel 1	1191	Integer Value		P
104	Over Analog Input Channel 2	1192	Integer Value		P
105	Over Analog Input Channel 3	1193	Integer Value		P
106	Over Analog Input Channel 4	1194	Integer Value		P
107	Under Analog Input Channel 1	1191	Integer Value		Q
108	Under Analog Input Channel 2	1192	Integer Value		Q
109	Under Analog Input Channel 3	1193	Integer Value		Q
110	Under Analog Input Channel 4	1194	Integer Value		Q
111-120	Reserved				
201	Voltage Swell A-N/A-B		Volts	D	R
202	Voltage Swell B-N		Volts	D	R
203	Voltage Swell C-N/C-B		Volts	D	R
204	Current Swell Phase A		Amps	A	R
205	Current Swell Phase B		Amps	A	R
206	Current Swell Phase C		Amps	A	R
207	Current Swell Neutral		Amps	B	R
208	Voltage Sag A-N/A-B		Volts	D	S
209	Voltage Sag B-N		Volts	D	S
210	Voltage Sag C-N/C-B		Volts	D	S
211	Current Sag Phase A		Amps	A	S
212	Current Sag Phase B		Amps	A	S
213	Current Sag Phase C		Amps	A	S
214	Current Sag Neutral		Amps	B	S



**ALARM TYPE DEFINITIONS**

<u>Alarm Type</u>	<u>Alarm Description</u>	<u>Alarm Operation</u>
A	Over Value Alarm	If the test register value exceeds the setpoint long enough to satisfy the pickup delay period, the alarm condition will be true. When the value in the test register falls below the dropout setpoint long enough to satisfy the dropout delay period, the alarm will dropout. Pickup and Dropout setpoints are positive, delays are in seconds.
B	Under Value Alarm	If the test register value is below the setpoint long enough to satisfy the pickup delay period, the alarm condition will be true. When the value in the test register rises above the dropout setpoint long enough to satisfy the dropout delay period, the alarm will dropout. Pickup and Dropout setpoints are positive, delays are in seconds.
C	Phase Loss, Current	The unbalance current alarm will occur when the percentage of the smallest phase current divided by the largest phase current is below the percentage pickup value, and remains at or below the pickup value long enough to satisfy the specified pickup delay in seconds. When the percentage of the smallest phase current divided by the largest phase current remains above the dropout value for the specified dropout delay period, the alarm will dropout. Pickup and Dropout setpoints are positive, delays are in seconds.
D	Phase Loss, Voltage	The Phase Loss Voltage alarm will occur when any one or two phase voltages (but not all) fall to the pickup value and remain at or below the pickup value long enough to satisfy the specified pickup delay. When all of the phases remain at or above the dropout value for the dropout delay period, or when all of the phases drop below the specified phase loss pickup value, the alarm will dropout. Pickup and Dropout setpoints are positive, delays are in seconds.
E	Lagging P.F.	The Lagging Power Factor alarm will occur when the test register value becomes more lagging than the pickup setpoint (i.e. closer to -0.010) and remains more lagging long enough to satisfy the pickup delay period. When the value becomes equal to or less lagging than the dropout setpoint (i.e. closer to 1.000) and remains less lagging for the dropout delay period, the alarm will dropout. Pickup setpoint must be negative. Dropout setpoint can be negative or positive. Enter setpoints as integer values representing power factor in thousandths. For example, to define a dropout setpoint of -0.5, enter -500. Delays are in seconds.
F	Leading P.F.	The Leading Power Factor alarm will occur when the test register value becomes more leading than the pickup setpoint (i.e. closer to 0.010) and remains more leading long enough to satisfy the pickup delay period. When the value becomes equal to or less leading than the dropout setpoint (i.e. closer to 1.000) and remains less leading for the dropout delay period, the alarm will dropout. Pickup setpoint must be positive. Dropout setpoint can be positive or negative. Enter setpoints as integer values representing power factor in thousandths. For example, to define a dropout setpoint of -0.5, enter -500. Delays are in seconds.
G	Over Power Demand	The over power demand alarms will occur when the test register's absolute value exceeds the pickup setpoint and remains above the pickup setpoint long enough to satisfy the pickup delay period. When the absolute value drops to below the dropout setpoint and remains below the setpoint long enough to satisfy the dropout delay period, the alarm will dropout. Pickup and Dropout setpoints are positive, delays are in seconds.

<u>Alarm Type</u>	<u>Alarm Description</u>	<u>Alarm Operation</u>
H	Over Lagging Average P.F.	<p>The Over lagging 3-phase Average P.F. will occur when the test register is less leading than the pickup setpoint and remains less leading for the pickup delay period. When the value becomes less lagging than the dropout setpoint and remains less lagging for the dropout delay, the alarm will dropout. If a leading P.F. is selected for the pickup setpoint (that is, a positive P.F.), then the alarm will be active for any lagging P.F. or for any leading P.F. between the pickup setpoint and unity. Pickup and Dropout setpoints can be positive or negative; delays are in seconds. Enter setpoints as integer values representing power factor in thousandths. For example, to define a dropout setpoint of -0.5, enter -500.</p> <p><b>Note:</b> This alarm condition is based on the average power factor over the last demand interval—not instantaneous power factor.</p>
I	Under Power	<p>The Under power alarm will occur when the test register's absolute value is below the pickup setpoint and remains below the pickup setpoint long enough to satisfy the pickup delay period. When the absolute value rises above the dropout setpoint and remains above the setpoint long enough to satisfy the dropout delay period, the alarm will dropout. Pickup and Dropout setpoints are positive, delays are in seconds.</p>
J	Over Reverse Power	<p>The over reverse power alarm will occur when the test register's absolute value exceeds the pickup setpoint and remains above the pickup setpoint long enough to satisfy the pickup delay period. When the absolute value drops to below the dropout setpoint and remains below the setpoint long enough to satisfy the dropout delay period, the alarm will dropout. This alarm will only hold true for Reverse Power conditions, i.e. any positive power value will not cause the alarm to occur. Pickup and Dropout setpoints are positive, delays are in seconds.</p>
K	Phase Reversal	<p>Once enabled the phase reversal alarm will occur whenever the phase voltage waveform rotation differs from the default phase rotation. It is assumed that an ABC phase rotation is normal. If a CBA normal phase rotation is normal, the user should reprogram the circuit monitor's phase rotation from ABC (default) to CBA phase rotation. The pickup and dropout setpoints and delays for phase reversal do not apply.</p>
L	Status Input Transitions Off to On	<p>The Status Input transitions alarms will occur whenever the status input changes from off to on. The alarm requires no pickup or dropout setpoints or delays. The Alarm will dropout when the status input changes back to off from on. The pickup and dropout setpoints and delays do not apply.</p>
M	Status Input Transitions On to Off	<p>The Status Input transitions alarms will occur whenever the status input changes from on to off. The alarm requires no pickup or dropout setpoints or delays. The alarm will dropout when the status input changes back to on from off. The pickup and dropout setpoints and delays do not apply.</p>
N	End Of Interval/Update Cycle	<p>The End of Interval alarms mark the end of an interval, or update cycle. The pickup and dropout setpoints and delays do not apply.</p>
O	Power-Up/Reset	<p>The Power-Up/Reset alarm marks any time the circuit monitor powers up or resets. The pickup and dropout setpoints and delays do not apply.</p>
P	Over Analog	<p>The Over Analog alarms will occur whenever the test register value is more positive than the pickup setpoint (or less negative) and remains greater than the pickup long enough to satisfy the pickup delay. When the value becomes less positive than the dropout setpoint (or more negative) and remains below the setpoint long enough to satisfy the dropout delay, the alarm will dropout. Pickup and Dropout setpoints can be positive or negative, delays are in seconds.</p>

<u>Alarm Type</u>	<u>Alarm Description</u>	<u>Alarm Operation</u>
Q	Under Analog	The Under Analog alarms will occur whenever the test register value is less positive than the pickup setpoint (or more negative) and remains less than the pickup long enough to satisfy the pickup delay. When the becomes more positive than the dropout setpoint (or less negative) and remains above the setpoint long enough to satisfy the dropout delay, the alarm will dropout. Pickup and Dropout setpoints can be positive or negative, delays are in seconds.
R	Voltage/Current Swell	The Voltage and Current Swell alarms will occur whenever the continuous RMS calculation is above the pickup setpoint and remains above the pickup setpoint for the specified number of cycles. When the continuous RMS calculations fall below the dropout setpoint and remain below the setpoint for the specified number of cycles, the alarm will drop out. Pickup and Dropout setpoints are positive, delays are in cycles.
S	Voltage/Current Sag	The Voltage and Current Sag alarms will occur whenever the continuous RMS calculation is below the pickup setpoint and remains below the pickup setpoint for the specified number of cycles. When the continuous RMS calculations rise above the dropout setpoint and remain above the setpoint for the specified number of cycles, the alarm will drop out. Pickup and Dropout setpoints are positive, delays are in cycles.
T	Suspended Sag/Swell	The suspended sag/swell alarm will occur whenever an excessive amount of current or voltage sag/swell alarms occur, typically due to erroneous alarm setpoints. If more than six of any one type of sag or swell alarm occurs within 500 ms, the disturbance monitoring detection in the circuit monitor will be suspended for approximately 8 seconds. The disturbance detection will then resume. If the disturbance detection is immediately suspended a second time, the user will have to clear register 2038 and re-enable the sag/swell alarms.



## APPENDIX E—READING AND WRITING REGISTERS FROM THE FRONT PANEL

The circuit monitor provides four setup modes: Configuration mode, Resets mode, Alarm/Relay mode, and Diagnostics mode. (See **The Setup Mode** in **Chapter 4** of the *Circuit Monitor Installation and Operation Bulletin* for a description of the first three of these modes.) This appendix tells how to use the Diagnostics mode.

The Diagnostics mode lets you read and write circuit monitor registers, from the front panel. This capability is most useful to users who 1) need to set up an advanced feature which *cannot* be set up using the circuit monitor's normal front panel setup mode, and 2) do not have access to POWERLOGIC software to set up the feature.

For example, the default operating mode for a circuit monitor relay output is *normal*. To change a relay's operating mode from normal to some other mode (for example, latched mode), you'd need to use either POWERLOGIC software or the Diagnostics setup mode.

*Note: Use this feature with caution. Writing an incorrect value, or writing to the wrong register could cause the circuit monitor to operate incorrectly.*

To read and/or write registers, complete the following steps:

1. Press the MODE button until the red LED next to [Setup] is lit.  
The circuit monitor displays "ConFig."
2. Press the down arrow SELECT METER [Value] button until "diAg" is displayed.
3. Press the PHASE [Enter] button to select the Diagnostics mode.  
The circuit monitor displays the password prompt "P - - -."
4. Enter the master password.

To enter the password, use the SELECT METER [Value] buttons to increase or decrease the displayed value until it reaches the password value. Then press the PHASE [Enter] button.

The circuit monitor display alternates between "rEg No" (an abbreviation for register number) and "1000" (the lowest available register number).

5. Use the SELECT METER [Value] buttons to increase or decrease the displayed register number until it reaches the desired number.
6. Press the PHASE [Enter] button.

The circuit monitor reads the register, then alternately displays the register number (in the format r.xxxx) and the register contents (as a decimal value). If you are viewing a metered value, such as voltage, the circuit monitor updates the displayed value as the register contents change. (Note that scale factors are not taken into account automatically when viewing register contents.)

7. To read another register, press the MODE button, then repeat steps 5 and 6 above.
8. To write to a register, continue with step 9 below.  
*Note: Some circuit monitor registers are read/write, some are read only. You can write to read/write registers only.*
9. Use the SELECT METER [Value] buttons to increase or decrease the displayed register number until it reaches the register you'd like to write.
10. Press the PHASE [Enter] button.  
The circuit monitor alternately displays the register number and the register contents (as a decimal value).
11. Use the SELECT METER [Value] buttons to increase or decrease the displayed decimal value until it reaches the value you'd like to write.  
If you've accidentally selected a *read only* register, the circuit monitor will not allow you to change the value.
12. Press the MODE button.  
The circuit monitor displays "No."
13. To abort the register write, press the PHASE [Enter] button.
14. To write the value, press the up arrow SELECT METER [Value] button to change from "No" to "Yes." Then press the PHASE [Enter] button.  
The display flashes, indicating that the value has been written, then returns to the register number.
15. To write another register, repeat steps 9–14 above.
16. To leave the Diagnostics mode, press the MODE button while the circuit monitor displays "rEg No."

*Note: You can use the diagnostics mode to execute commands using the circuit monitor's command interface. First, write the desired values to the command parameter registers. Then, write the code to execute the command. See **The Command Interface in Chapter 9** for a description of the command interface.*

**INDEX****A**

Abbreviated register listing 83  
 Advanced topics 61–76  
 Alarm  
   conditions and numbers 118  
   setup information 117  
   type definitions 121  
 Alarm conditions and alarm numbers 118  
 Alarm Functions 31  
 Alarm setpoints  
   scaling 117–118  
 Alarm setup 117  
 Alarm type definitions 121  
 Alarms  
   sag/swell 55  
   Setpoint-driven 31  
 Alternate VAR sign convention 11  
 Analog inputs 20  
 Analog outputs 29

**B**

Block/rolling command, changing the 75

**C**

CAB-102, CAB-104 81  
 CAB-107 81  
 CAB-108 81  
 Calculating log file sizes 115  
 CC-100 81  
 Changing the VAR sign convention 72  
 Circuit monitor  
   configuration values 96  
   description 1  
   electromagnetic phenomena measurement 51  
   feature comparison 3, 4, 5  
   instrumentation 3  
   types 3  
   utility registers 104  
   waveform capture, setting up for 42  
 CM-2452  
   application examples 60  
 Command codes 62  
 Command interface 61  
   control 73  
 Command interface control 73  
 Command interface, operating relays using the 64

Communication cable pinouts 81  
 Communications link, controlling demand interval 76  
 Conditional energy 73

**D**

Data logging 38  
   alarm-driven entries 38  
   organized files 38  
   storage considerations 39  
 Date and time, setting using command interface 69  
 De-energizing a relay 64  
 Default VAR sign convention 11  
 Demand calculation method, changing the 75  
 Demand interval over the comms link, controlling 76  
 Demand readings  
   generic demand 14  
   peak demand 13  
   predicted demand 13  
   voltage demand 14  
 Demand synch pulse input 19  
 Demand synch pulse input, setting up a 76  
 Developer's kit 60  
 Disturbance monitoring 49  
   high-speed event log entries 57  
   sag/swell alarms 55  
   voltage sag/swell 50

**E**

Energizing a relay 64  
 Energy readings 14  
 Event log  
   high speed entries 57  
   storage 37  
 Extended event capture 44  
 Extended metering ranges, setting scale factors for 66

**F**

Fax-On-Demand 7  
 Front panel  
   reading and writing from the 125

**G**

Generic demand 14

## H

Harmonic calculations, setting up individual 77  
High-speed event log entries 57  
How power factor is stored 71

## I

Incremental energy 74  
    using 74  
Input modules 17  
Interface  
    command 61  
Introduction 1

## L

Log file sizes, calculating 115  
Logging 37–40  
    data 38  
    event 37  
    maintenance 40

## M

Maintenance log 40  
Memory allocation 69  
Memory configuration example 71  
Metering capabilities 9  
Min/max  
    power factor conventions 10  
    values 10  
Min/max values 10  
Monitoring, disturbance 49  
Multiple waveform retrieval  
    using SMS-3000, SMS-1500, or PMX-1500 56  
    using SMS-770, SMS-700, EXP-550, or EXP-500 56

## O

Operating relays using command interface 64  
Output modules 17  
Overriding an output relay 65

## P

Peak demand 13  
Pinouts  
    communications pinouts 81  
Power analysis values 15, 16  
Power factor, how it is stored 71  
Power factor min/max conventions 10  
Predicted demand 13  
Programming language 59–60

Pulse counting example 78  
Pulse demand metering  
    via status input 78

## R

Reading and writing registers from the front panel 125  
Readings  
    demand 12  
    energy 14  
    real-time 9  
Real-time readings 9  
Register listing 83  
    analog input configuration 103  
    analog input max 89  
    analog input min 86  
    analog input present value 86  
    analog output configuration 102  
    circuit monitor utility 104  
    CM configuration values 96  
    date/time (compressed) 91  
    date/time (expanded) 92  
    demand values 90  
    energy values 89  
    KYZ and relay outputs 94  
    neutral current 112  
    phase A current 107  
    phase A voltage 106  
    phase B current 109  
    phase B voltage 108  
    phase C current 111  
    phase C voltage 110  
    real time metered values maximum 88  
    real time metered values minimum 86  
    sag/swell event 101  
    status input pulse demand metering 104  
    status inputs 93  
Register listings  
    spectral components 106  
Registers  
    reading and writing from front panel 125  
Related documents 7  
Relay  
    setpoint-controlled functions 33  
Relay, de-energizing a 64  
Relay, energizing a 64  
Relay output operating modes 22  
Relay, overriding an output 65  
Relay, releasing an overridden 65  
Relay, setting up for CM (internal) control 65  
Releasing and overridden relay 65



**S**

- Safety precautions 5, 6
- Sag/swell alarms 55
- Scaling alarm setpoints 117
- Setpoint controlled relay functions 25
- Setpoint-controlled relay functions 33
- Setting scale factors for extended metering ranges 66
- Setting the date and time using the command interf 69
- Setting up relays for CM (internal) control 65
- Setting up relays for remote (external) control 64
- Setup
  - alarm 117
- Software
  - instruction bulletins 7
- Status input
  - pulse demand metering 78
- Status input control 73

**V**

- VAR sign convention
  - alternate 11
  - default 11, 72
  - optional 72
- VAR sign convention, changing the 72
- Voltage demand 14
- Voltage sag/swell 50

**W**

- Waveform capture 41–47
  - 4-cycle
    - automatic 41
    - manual 41
  - CM-2452 memory allocation (12-cycle) 55
  - extended event
    - automatic (high-speed trigger) 44
    - automatic (standard setpoint) 46
    - manual 44
    - storage 47
  - high-speed trigger 44
  - multiple setup
    - using SMS-3000, SMS-1500, or PMX-1500 52
    - using SMS-770, SMS-700, EXP-550, or EXP-500 54
  - setting up circuit monitor for 42
  - storage 43
- Waveform storage 43

Square D Company  
295 Tech Park Dr., Suite 100  
LaVergne, TN 37086 USA

Printed in USA

Order No. 3020IM9806

(Replaces 3020IM9301R10/97 dated January 1998)



**SQUARE D**