

Momentum

170ENT11001/170ENT11002

Ethernet Communications Adapter User Guide

870 USE 114 00 Version 2.0

31004109 02



Telemecanique

Table of Contents



	Safety Information	7
	About the Book	9
Part I	Momentum 170ENT11001 Ethernet Communication Adapter	13
	At a Glance	13
Chapter 1	Product Description — Momentum 170ENT11001	15
	Adapter Overview - Momentum 170ENT11001	15
Chapter 2	Installing the Momentum 170ENT11001	21
	At a Glance	21
	Assembling a Processor Adapter onto an I/O Base	22
	Disassembling a Momentum 170ENT11001 from an I/O Base	25
	Guidelines for Labeling the Momentum 170ENT11001	27
Chapter 3	Setting Up a Momentum 170ENT11001	29
	At a Glance	29
	Booting Up Out of the Box	30
	Choosing to Use FDR	32
	Step by Step to Using FDR	33
	Step by Step to Using BOOTP or Stored IP	34
Chapter 4	Using the Momentum 170ENT11001 Embedded Web Pages	37
	At a Glance	37
4.1	Navigating the Momentum 170ENT11001 through Embedded Web Pages	38
	At a Glance	38
	Accessing the Momentum 170ENT11001 through the Entry and Home Pages	39
	Controlling Web Page Access with Passwords	43
	Viewing the Momentum 170ENT11001 I/O Properties	45
	Using the Momentum 170ENT11001 Configuration Web Pages	46
	Accessing the Momentum 170ENT11001 Diagnostics	48

4.2	Configuring the Momentum 170ENT11001 through the Embedded Web Pages	50
	At a Glance	50
	Configuring the Momentum 170ENT11001 IP Parameters	51
	Configuring the Momentum 170ENT11001 Communication Adapter Parameters	54
	Configuring the Current SNMP Configuration	57
	Clearing the Momentum 170ENT11001 Configuration Parameters	59
Chapter 5	Accessing the Momentum 170ENT11001 through the Registers.	61
	At a Glance	61
	Understanding the Internal Registers	62
	Using the Data Group Registers	64
	Configuring Parameters through the Configuration Group Registers	65
	Using the Status Group Registers	69
Chapter 6	Using Faulty Device Replacement	71
	At a Glance	71
	Understanding Faulty Device Replacement.	72
	Booting with FDR Enabled.	76
	Replacing a Faulty Device.	78
	FDR Run Time.	81
Chapter 7	Using SNMP	85
	At a Glance	85
	Understanding SNMP	86
	ASN.1 Naming Scheme.	88
	Configuring a Momentum 170ENT11001 with SNMP	90
	Using Private MIBs for Momentum 170ENT11001 Diagnostics	92
Chapter 8	Using the Network Options Ethernet Tester	99
	At a Glance	99
	Installing the Network Options Ethernet Tester	100
	Establishing a Connection with an Ethernet Module	101
	Getting and Clearing Statistics.	103
	Understanding Statistics	106
	Reading Registers	108
	Writing Registers	109
	Using the Test Button	111
Part II	Momentum Model 170ENT11000/170ENT11002 Ethernet Communication Adapter	113
	At a Glance	113

Chapter 9	Momentum Ethernet Communication Adapter	
	170ENT11000/170ENT11002	115
	At a Glance	115
	Product Overview	116
	Example: Data Turnaround Time	119
	Status Indicators	121
	Connecting to the Network	123
	Placing the Adapter into Service	124
	Replacing an Adapter	126
Chapter 10	Communicating with the Adapter	129
	Communication Access Registers	129
Appendices		137
	At a Glance	137
Appendix A	Specifications - Momentum 170ENT11001 and	
	Momentum 170ENT11002 (170ENT11000)	139
	Specifications - Momentum 170ENT11001	139
Appendix B	IP Parameter Resolution State Table -	
	Momentum 170ENT11001	141
	IP Parameter Resolution State Table - Momentum 170ENT11001	141
Appendix C	Configuration Parameter Resolution State Table -	
	Momentum 170ENT11001	143
	Configuration Parameter Resolution State Table -	
	Momentum 170ENT11001	143
Appendix D	LED Status Indicators — Momentum 170ENT11001	147
	LED Status Indicators	147
Appendix E	Deriving an IP Address from a MAC Address	151
	Deriving an IP Address from a MAC Address	151
Appendix F	Establishing an Active Route —	
	Momentum 170ENT11001	153
	Establishing an Active Route — Momentum 170ENT11001	153
Glossary		155
Index		163

Safety Information

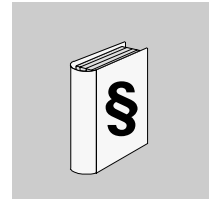

Important Information

NOTICE

Read these instructions carefully, and look at the equipment to become familiar with the device before trying to install, operate, or maintain it. The following special messages may appear throughout this documentation or on the equipment to warn of potential hazards or to call attention to information that clarifies or simplifies a procedure.



The addition of this symbol to a Danger or Warning safety label indicates that an electrical hazard exists, which will result in personal injury if the instructions are not followed.



This is the safety alert symbol. It is used to alert you to potential personal injury hazards. Obey all safety messages that follow this symbol to avoid possible injury or death.



DANGER

DANGER indicates an imminently hazardous situation, which, if not avoided, **will result** in death, serious injury, or equipment damage.



WARNING

WARNING indicates a potentially hazardous situation, which, if not avoided, **can result** in death, serious injury, or equipment damage.



CAUTION

CAUTION indicates a potentially hazardous situation, which, if not avoided, **can result** in injury or equipment damage.

PLEASE NOTE

Electrical equipment should be serviced only by qualified personnel. No responsibility is assumed by Schneider Electric for any consequences arising out of the use of this material. This document is not intended as an instruction manual for untrained persons.

© 2003 Schneider Electric All Rights Reserved.

About the Book

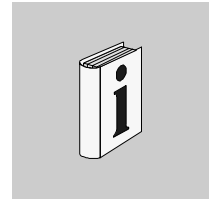

At a Glance

Document Scope This user guide describes the Momentum models 170ENT11001 and 170ENT11002 Ethernet communication adapters. These communication adapters plug onto any model of Momentum I/O module and provide a direct connection to Ethernet-based networks. The adapter conforms to the requirements of the Ethernet Communication Network.

Throughout this material we use the following naming scheme.

Full Name of Product	Name Used in this Guide
Momentum model 170ENT11001 Ethernet communication adapter	Momentum 170ENT11001 or the adapter or device
Momentum model 170ENT11002 Ethernet communication adapter	Momentum 170ENT11002 or the adapter or device

The Momentum 170ENT11001 and the Momentum 170ENT11002 adapters provide a direct connection to Ethernet-based networks for the entire family of Momentum I/O modules. This connectivity enables communications with a full range of Ethernet TCP/IP compatible control products, a range that includes programmable controllers, industrial computers, motion controllers, operator control stations, host computers, and other controls.

Both the Momentum 170ENT11001 and Momentum 170ENT11002 are available from Schneider Electric. The Momentum 170ENT11002 replaces the Momentum 170ENT11000.

The Momentum 170ENT11001, an Ethernet communication adapter, offers the following features.

- 10/100Base-T
- Backwards compatible
- Enhanced power-up error detection
Momentum 170ENT11001 will detect and indicate default IP Address condition.
- Embedded Web pages for configuration
A series of Web configuration pages enables you to configure some options in the system.
Configure the Momentum 170ENT11001 in its default (out-of-the-box) condition in the absence of a BOOTP / DHCP server or previous configuration.
- Embedded Web pages for diagnostics
A series of Web diagnostic pages enables you to monitor the health of the system.
- Enhanced LED error reporting
- SNMP
Simple Network Management Protocol
All Ethernet devices will support Simple Network Management Protocol (SNMP).
All Ethernet devices will support both public MIBs and the Schneider Electric Private MIB for device management on the network.
- FDR
Faulty Device Replacement
The adapter supports Faulty Device Replacement—client
As an FDR client the adapter will retrieve its IP and configuration parameters from a DHCP server and FTP server respectively. The presence or absence of a role name will control participation in an FDR environment.

Validity Note

The data and illustrations found in this book are not binding. We reserve the right to modify our products in line with our policy of continuous product development. The information in this document is subject to change without notice and should not be construed as a commitment by Schneider Electric.

Related Documents

Title of Documentation	Reference Number
Momentum I/O Base User Guide: Volume I: General Information, Analog and Power Modules	870USE00200
Momentum I/O Base User Guide: Volume II: Discrete Modules	870USE00200
Ladder Logic Block Library User Guide	840USE10100

**Product Related
Warnings**

Schneider Electric assumes no responsibility for any errors that may appear in this document. If you have any suggestions for improvements or amendments or have found errors in this publication, please notify us.

No part of this document may be reproduced in any form or by any means, electronic or mechanical, including photocopying, without express written permission of the Publisher, Schneider Electric.

All pertinent state, regional, and local safety regulations must be observed when installing and using this product. For reasons of safety and to assure compliance with documented system data, only the manufacturer should perform repairs to components.

User Comments

We welcome your comments about this document. You can reach us by e-mail at TECHCOMM@modicon.com.

Momentum 170ENT11001 Ethernet Communication Adapter

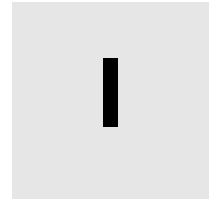

At a Glance

Purpose

The content in this first part describes the Momentum model 170ENT11001 Ethernet communication adapter. This adapter may be configured using the embedded Web pages or through the Modbus TCP/IP protocol. The second part contains material that describes the Momentum model 170ENT11002 Ethernet communication adapter, which is configured using the Modbus TCP/IP protocol.

What's in this Part?

This part contains the following chapters:

Chapter	Chapter Name	Page
1	Product Description — Momentum 170ENT11001	15
2	Installing the Momentum 170ENT11001	21
3	Setting Up a Momentum 170ENT11001	29
4	Using the Momentum 170ENT11001 Embedded Web Pages	37
5	Accessing the Momentum 170ENT11001 through the Registers	61
6	Using Faulty Device Replacement	71
7	Using SNMP	85
8	Using the Network Options Ethernet Tester	99

Product Description — Momentum 170ENT11001

1

Adapter Overview - Momentum 170ENT11001

Overview

This section provides a general overview of the Momentum 170ENT11001, the I/O base to which the adapter is attached, the key features, and components.

Front Panel Components

The following figure shows the front of a Momentum 170ENT11001 Ethernet communication adapter.

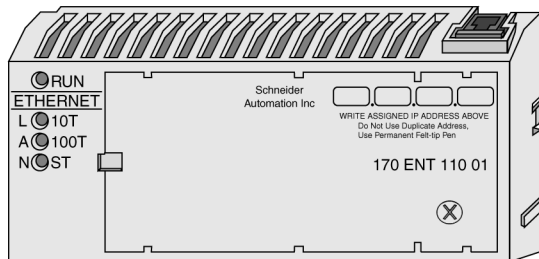

**General
Description**

The Ethernet communication adapter, Momentum 170ENT11001, enables the connection of the complete family of Momentum I/O modules to an Ethernet network, at either a 10Base-T or 100Base-T communication rate.

The Momentum 170ENT11001 is attached to a Momentum I/O module. The Momentum 170ENT11001 offers the following functions using Ethernet connections.

- configure the module through embedded Web pages

- exchange
 - input and output data
 - configuration informationExchanges communicate using a defined set of Modbus commands over the TCP/IP protocol
- obtain diagnostic information using
 - LEDs appearing on the module
 - communication statistics displayed on Web pages

- download
 - operating parameters using the FDR service
 - Exec. and kernel updates

The Momentum 170ENT11001 offers the following functions using registers. (See *Configuring Parameters through the Configuration Group Registers, p. 65*)

- allows up to 3 devices to have write access to the Momentum 170ENT11001 with the option of storing their IP addresses in FLASH

- select holdup timeouts either
 - 0 (zero), which selects an indefinite holdup timeout
 - 30 (300 milliseconds) through 6000 (60 seconds) in 10 millisecond intervalsHoldup timeouts may be store stored to FLASH.
For further information about holdup timeouts, see .

- select ownership reservation time
 - 30 (300 milliseconds) through 6000 (60 seconds) in 10 millisecond intervalsOwnership reservation time can be saved in FLASH.

The Momentum 170ENT11001 is one of many communication adapters that mate to a Momentum I/O base in the Momentum family of products.

**Increased
Functionality**

Using a Momentum 170ENT11001 provides all the functionality of the Momentum 170ENT11000 (replaced with the Momentum 170ENT11002), but the Momentum 170ENT11001 offers three additional features:

- FDR

Faulty Device Replacement

A feature providing ease of maintenance and a backup repository. See the chapter, *Using Faulty Device Replacement*, p. 71.

- Configuration via standard Web browser software

Configure your system with a Web browser. Changes to the system are made easily from these Web pages. See the chapter, *Using the Momentum 170ENT11001 Embedded Web Pages*, p. 37

- SNMP
Simple Network Management Protocol

SNMP is a powerful, diagnostic tool that provides access to system statistics, which you use to monitor the health of your system. See the chapter, *Using the Momentum 170ENT11001 Embedded Web Pages*, p. 37

You may configure a Momentum 170ENT11001 for your needs. The Momentum 170ENT11001 is backward compatible. You may use the Momentum 170ENT11001 as a replacement for a Momentum 170ENT11000. You may use this guide for the Momentum 170ENT11001 and the Momentum 170ENT11000/Momentum 170ENT11002.

Ensure that the controller's communication timeout is long enough to match the network performance and the response time of the Momentum 170ENT11001.

<p>Note: Schneider Electric recommends that you use Ethernet switches for distributed I/O networks because switches give more deterministic responses.</p>

Key Features

The Momentum 170ENT11001 includes all the functionality of the Momentum 170ENT11000 communication adapter. (The Momentum 170ENT11000 was replaced with the Momentum 170ENT11002.) The Momentum 170ENT11001 offers the following expanded services:

- communication ports

10/100 Mb Ethernet communication port with auto-negotiate capability will:

- automatically detect the port speed of 10 Mbps or 100 Mbps
- auto-negotiate half-duplex / full-duplex port operation

- framing methods

10/100 Mb Ethernet communication will support:

- Ethernet II framing
- IEEE 802.3 framing
- Auto-detect framing

In Auto-detect framing mode the Momentum 170ENT11001 attempts three (3) BOOTP requests with Ethernet II framing. If no response is received, the adapter will then attempt three (3) BOOTP requests with IEEE 802.3 framing.

If a valid configuration exists, the framing type of that configuration will be used. The framing type of the first BOOTP/DHCP response will be chosen as the framing-type run parameter. If no server responds, the default framing type will be Ethernet II.

- enhanced IP Address acquisition

A Momentum 170ENT11001 will obtain an IP address from

1. BOOTP / DHCP server
2. Manual configuration
3. Default IP parameters based on adapter's MAC address

- parameter management (at initialization time and execution time)

- enhanced power-up error detection

A Momentum 170ENT11001 will detect and indicate default IP Address condition, duplicate IP Address condition, and complex I/O base failure.

- embedded Web pages used for configuration

A series of Web configuration pages enables you to configure some options in the system.

Configure the Momentum 170ENT11001 in its default (out-of-the-box) condition in the absence of a BOOTP / DHCP server or previous configuration.

- embedded Web pages used for diagnostics

A series of Web diagnostic pages enables you to monitor the health of the system.

- enhanced LED error reporting
- SNMP

Full support of Simple Network Management Protocol (SNMP). Support of public MIB-2 and the Schneider Electric Transparent Factory Private MIB for device management on the network.

- FDR

The adapter supports Faulty Device Replacement—client

As an FDR client the adapter will retrieve its IP and configuration parameters from a DHCP server and FTP server respectively. The presence or absence of a role name will control participation in an FDR environment.

The Momentum 170ENT11001 communication adapter will allow a Momentum I/O base both to reside on an Ethernet network and to communicate using Modbus messages over TCP/IP protocol.

Installing the Momentum 170ENT11001

2

At a Glance

Purpose

The following material describes how to assemble and disassemble a Momentum 170ENT11001, using the following components:

- Momentum 170ENT11001 Ethernet Communication Adapter
- I/O Base
- Label

What's in this Chapter?

This chapter contains the following topics:

Topic	Page
Assembling a Processor Adapter onto an I/O Base	22
Disassembling a Momentum 170ENT11001 from an I/O Base	25
Guidelines for Labeling the Momentum 170ENT11001	27

Assembling a Processor Adapter onto an I/O Base

Overview

This section contains safety precautions and a procedure for assembling (attaching) an adapter to an I/O base.

General Description

An Ethernet communication adapter can be snapped directly onto a Momentum I/O base, making connections at three points:

- The plastic snap extensions on the two sides of the Momentum 170ENT11001 unit fit into the two slots on the sides of the I/O base
- The 12-pin connectors on the two units mate together
- The grounding screw is secured

The components can be snapped together by hand – no assembly tools are required.

This section contains safety precautions for handling components and a procedure for assembling an adapter and an I/O base.

	CAUTION
	ADAPTER MAY BE DAMAGED BY STATIC ELECTRICITY The adapter's electrical elements are sensitive to static electricity. <ul style="list-style-type: none">● Use proper electrical static discharge (ESD) procedures when handling the adapter.● Do not touch the internal elements. Failure to follow this precaution can result in injury or equipment damage.

	CAUTION
	EXPOSED ELECTRICAL CIRCUITRY Electrical circuitry on the I/O base may be exposed when a Momentum adapter is not mounted. <ul style="list-style-type: none">● Ensure that the I/O base is not under power when it does not have an adapter mounted on it.● To make sure that power is not present, do not insert the wiring connectors to the I/O base until after the adapter has been mounted. Failure to follow this precaution can result in injury or equipment damage.

For a detailed description of installation procedures and grounding considerations, refer to the *Momentum I/O Bases User Guide, Volumes I and II* (870USE00200).

**Procedure:
Assembling an
Adapter and an
I/O Base**

Follow the steps below to assemble an adapter and an I/O base.

Step	Action
1	Choose a clean environment to assemble the I/O base and adapter to protect the circuitry from contamination.
2	Make sure that the I/O base is not under power when you assemble the module.
3	Align the two plastic snap extensions on the adapter with the slots on the sides of the I/O base. The 12-pin connectors will automatically line up when the units are in this position. The two devices should be oriented so their communication ports are facing out, on the back side of the assembly.

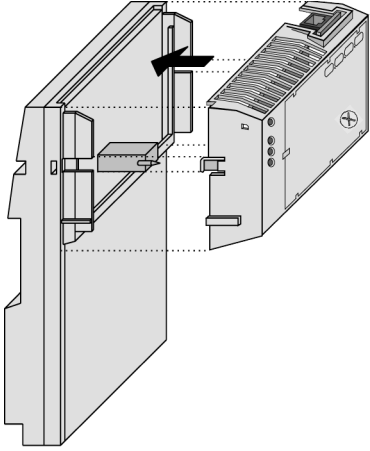

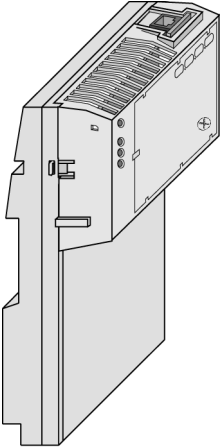
Step	Action
4	<p data-bbox="481 201 1236 310">Push the adapter onto the base, gently pressing the locking tabs inward. Result: The locking tabs on each side of the adapter slide inside the I/O base and out through the locking slot. The 12-pin connectors on the two units are mated in the process.</p> 
5	<p data-bbox="481 807 746 828">Attach the grounding screw.</p>
6	<p data-bbox="481 844 1229 979">Once the adapter has been assembled and snapped onto a base and the grounding screw secured, the entire assembly can be mounted on a DIN rail or panel. The device meets CE mark requirements for open equipment. Open equipment should be installed in an industry-standard enclosure, and direct access must be restricted to qualified service personnel.</p>

Disassembling a Momentum 170ENT11001 from an I/O Base

Overview

This section contains safety precautions and a procedure for disassembling an adapter from an I/O base.

	<p>CAUTION</p>
	<p>EXPOSED ELECTRICAL CIRCUITRY</p> <p>Electrical circuitry on the I/O base may be exposed when a Momentum adapter is not mounted.</p> <ul style="list-style-type: none"> ● Ensure that the I/O base is not under power when it does not have an adapter mounted on it. ● To make sure that power is not present, do not insert the wiring connectors to the I/O base until after the adapter has been mounted. <p>Failure to follow this precaution can result in injury or equipment damage.</p>

Tools Required

A flat-head screw driver.

Procedure: Disassembling an Adapter from an I/O Base

Follow the steps in the table below to remove an adapter from an I/O base.

Step	Action
1	Choose a clean environment to disassemble the unit, in order to protect the circuitry from contamination.
2	Make sure that the I/O base is not under power by removing the terminal connectors from the I/O base.
3	Remove the grounding screw.

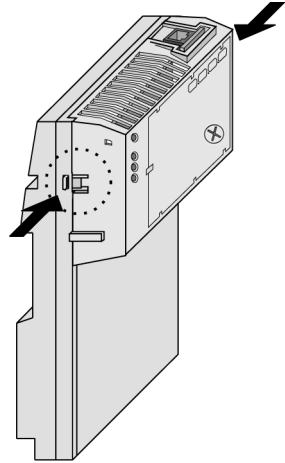
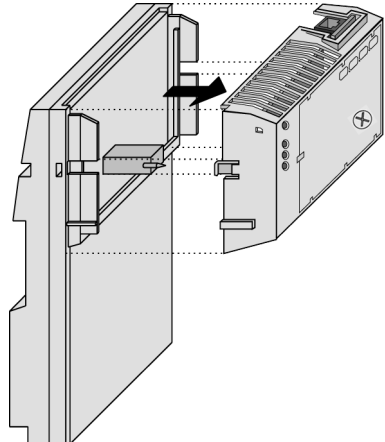
Step	Action
4	<p data-bbox="454 196 1244 256">Use a screwdriver to push the locking tabs on both sides of the adapter inward, as shown in the illustration below.</p>  <p>The diagram shows a side view of the adapter. Two black arrows point to the locking tabs on the left and right sides of the front panel. The adapter is shown in a perspective view, highlighting its rectangular shape and the front panel with a handle and a circular logo.</p>
5	<p data-bbox="454 748 1244 781">Lift adapter straight up and away from base, maintaining pressure on locking tabs.</p>  <p>The diagram shows a cross-section of the base and the adapter. A black arrow points upwards from the adapter, indicating the direction of removal. Dotted lines represent the alignment of the adapter with the base. The adapter is shown being lifted away from the base, with the locking tabs still engaged.</p>

Guidelines for Labeling the Momentum 170ENT11001

Overview

This section describes the label and provides an illustrated example.

Fill-In Label

A fill-in label is shipped with each I/O base. This label should be placed on the Momentum 170ENT11001 that you mount on that base.

A completed label provides information about the assembled module and its I/O field devices that can be used by service and maintenance personnel.

The model number of the I/O base is marked on the fill-in label directly above the color code. The cutout area above the I/O model number allows the model number of the adapter to show through.

Note: An adapter may also be used in the assembled module. You will find its model number printed in the upper left corner of adapter housing.

Example of a Fill-In Label

A fill-in label is illustrated in the illustration below. The numbered pointers in the illustration refer to the descriptions in the table that follows.

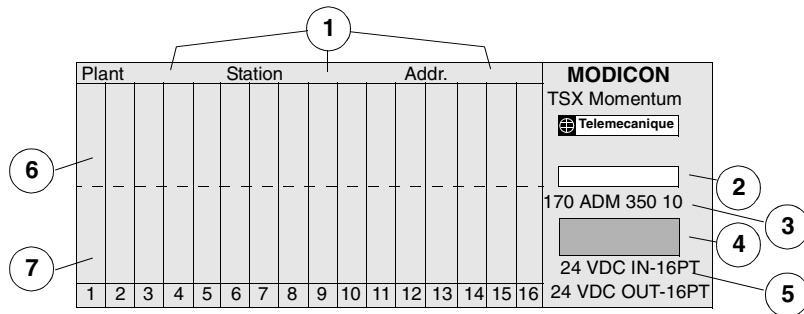

Legend:

No.	Description
1	Fields for plant name, station name and network address
2	Cutout—the model number of the adapter shows through
3	Model Number of the I/O base
4	Color code of the I/O base
5	Short description of the I/O base
6	Field for the symbol name of inputs
7	Field for the symbol name of outputs

Setting Up a Momentum 170ENT11001

3

At a Glance

Purpose

This material describes the process of setting up a Momentum 170ENT11001, a Schneider Electric Ethernet-based communication adapter (device). After the device has been removed from the box and placed on the module, you need to connect to the device. Once connected, you should configure both an IP address appropriate for your system and the configuration (runtime) parameters.

What's in this Chapter?

This chapter contains the following topics:

Topic	Page
Booting Up Out of the Box	30
Choosing to Use FDR	32
Step by Step to Using FDR	33
Step by Step to Using BOOTP or Stored IP	34

Booting Up Out of the Box

Connecting to an Adapter (Device) the First Time

The following paragraphs describe the process of taking a new Momentum 170ENT11001 out of the box and making it work.

The Momentum 170ENT11001 is an Ethernet communication adapter. All Ethernet devices are assigned a unique MAC address. Therefore, each Momentum 170ENT11001 is assigned a unique MAC address at the Schneider Electric factory. Generally, Ethernet devices are addressed by an IP address. Therefore, in order to operate in a local network, the device needs an IP address. In the out-of-the-box state, when power is applied to the Momentum 170ENT11001, the device obtains an IP address from either

1. BOOTP/DHCP server serving an IP address, or
2. default IP address (derived from MAC address)

Using a BOOTP/DHCP Server

Do the following

Step	Action
1	You must enter the MAC address and IP address of your Momentum 170ENT11001 into the Address Table of the BOOTP or DHCP server.
2	Power up Momentum 170ENT11001. Note: Device may take up to 60 seconds to boot up.
3	If no IP address is received from the server, wait an additional 30 seconds and the Momentum 170ENT11001 will use its default IP address and I/Os are not operational.

Using a Default IP Address

Do the following

Step	Action
1	Power up Momentum 170ENT11001. Note: Device may take up to 90 seconds to boot up and I/Os are not operational.

Note: See the appendix for deriving an IP address from a MAC address *Deriving an IP Address from a MAC Address, p. 151*. It may be necessary to add a route to your personal computer (PC) in order to communicate with the device. (See *Establishing an Active Route — Momentum 170ENT11001, p. 153*)

In the out-of-the-box state, after obtaining an IP address by BOOTP/DHCP, the device has a default set of runtime parameters and the I/Os are operational. If you are using the default IP parameters, the device does not have default runtime parameters and the I/Os are not operational.

The runtime parameters are the (1) communication adapter parameters, (2) SNMP configuration parameters, and (3) security configuration parameters. You SHOULD configure both the IP and runtime parameters for your needs. Configuring is discussed later.

What's Next

After you have connected to a device out of the box, you need to configure the device for use in your system.

You SHOULD configure both the IP and runtime parameters for your needs.

Configuring is discussed later

You may configure a device to use FDR, to use a BOOTP server, or to use a stored IP address.

Choosing to Use FDR

How to Decide

After you have connected to a device out of the box, you need to configure the device for use in your system. You may configure a device to use FDR, to use a BOOTP server, or to use a stored IP address.

Using the Faulty Device Replacement (FDR) service provides significant benefits. Using FDR requires using a RoleName for the device and an FDR server is present in your system. A RoleName is a user friendly identifier given to the device. Two examples follow

- **ENT_6** (6th Momentum 170ENT11001 in your application)
- **OUTPUT_VALVE_2** (2nd Output Valve in your application)

For a complete discussion of FDR and RoleNames, see *Understanding Faulty Device Replacement, p. 72*.

The choice between serving an IP address from an FDR server or not depends upon both your automation environment and your needs for replacement capabilities.

Benefits of FDR

Choice	Reason for Using
Using FDR	FDR provides <ul style="list-style-type: none"> ● centralized IP management ● centralized storage of configuration (runtime) parameters ● configuration parameters are never lost ● technician only needs to know the device's RoleName to replace a faulty device ● simplified maintenance ● ease of system management
Not using FDR	No FDR server is available

Using FDR requires assigning a unique RoleName to your Momentum 170ENT11001.

Step by Step to Using FDR

Assigning an IP Address from an FDR Server

In order to enter a RoleName into a device's Web page, either allow the device to power up in its default IP or assign a temporary IP address using the out-of-the-box process. (See *Booting Up Out of the Box*, p. 30) Connect to the device with a browser either using a personal computer (PC) on the same subnet or by adding a route to the PC using the route add method described in *Establishing an Active Route — Momentum 170ENT11001*, p. 153.

Do the following.

Step	Action
1	Browse to the FDR server's configuration Web page (such as a Quantum NOE or Premium ETY).
2	Enter the RoleName and IP address in the <i>FDR Server Table</i> of the FDR server.
3	Browse to the Communication Adapter Parameters Web page. Give the Momentum 170ENT11001 the desired configuration (runtime) parameters and store them in FLASH. Storing is executed by performing the save action. Before storing, enter the configuration password (httpcfguser).
4	Go to the IP Parameters Web page, and enter the Role Name into the adapter through the Web page and reboot (The system automatically prompts you to reboot.). Before storing, enter the configuration password (httpcfguser).

Note: To participate in the benefits of Faulty Device Replacement (FDR), a RoleName is required.

FDR in a Nutshell

The RoleName is stored in non volatile memory, FLASH, and the configuration (runtime) parameters are stored on the FDR server. Therefore, after a power failure all configurations will be available. After that power failure, the Momentum 170ENT11001 will remember its RoleName (stored in FLASH) and request its configuration (runtime) parameters from the FDR server.

Step by Step to Using BOOTP or Stored IP

Using IP Address Served from a BOOTP Server

When using BOOTP or stored IP, you should configure the device's configuration (runtime) parameters. If you do not configure the configuration parameters, the device will use a set of default parameters that may not be appropriate for your system.

To serve the IP address by BOOTP server,

Step	Action
1	Go to Communication Adapter Configuration page of the device.
2	Configure the configuration (runtime) parameters for your system.
3	Enter the configuration password (httpcfguser).
4	Enter the MAC address and IP address into the address table of either your BOOTP or a DHCP server. <ul style="list-style-type: none"> To obtain an IP address by a BOOTP server, Schneider Electric recommends using the Ethernet Configuration Tool available with the Concept panel software.
5	Reboot the device.

Using an IP Address Saved in Flash

If the Momentum 170ENT11001, the device, has IP parameters stored in Flash memory, the device uses those stored IP parameters.

To save an IP address in FLASH,

Step	Action
1	Go to Communication Adapter Configuration page of the device.
2	Configure the configuration (runtime) parameters for your system.
3	Go to the Configure IP Parameters Web page.
4	Enter the IP parameters.
5	Select the "Fall Back to Stored IP Parameters in the absence of an address server." check box (IPFallback flag).
6	Enter the configuration password (httpcfguser).
7	Click the Update Stored Values button.
8	Select reboot.

When the Momentum 170ENT11001 reboots, it will issue BOOTP requests for 30 seconds and then use the IP address stored in FLASH.

**Using a Default
IP Address**

If you do not have an FDR server or a BOOTP/DHCP server available, access the Momentum 170ENT11001 by using its default IP address. When the device boots up and if no BOOTP reply is received and there are no IP parameters stored in FLASH, the Momentum 170ENT11001 will derive its default IP parameters from its MAC address. (See *Deriving an IP Address from a MAC Address*, p. 151) Accessing the device through its default IP address, may require adding a route to your PC. (See *Establishing an Active Route — Momentum 170ENT11001*, p. 153)

<p>Note: When the Momentum 170ENT11001 is using default IP parameters, the device is in Safe I/O mode (I/O communication is disabled) and does not communicate with the Inputs and Outputs of the module.</p>
--

Understanding Device's Procedure for Obtaining an IP Address

When powered up, the device uses the following decision path to obtain an IP address.

If...	Then ...
Power applied to the device	<p>Device sends a message to a BOOTP/DHCP server requesting an IP address</p> <ul style="list-style-type: none"> ● Device uses IP address served from a BOOTP server ● Device checks for configuration (runtime) parameters <ul style="list-style-type: none"> ● If configuration (runtime) parameters EXIST in FLASH, <p>Device uses configuration (runtime) parameters. Device is operational.</p> ● If configuration (runtime) parameters do NOT exist in FLASH, <p>Device uses default configuration parameters and is operational</p> <p>Note: Default parameters may not be appropriate for your system.</p>
BOOTP/DHCP server fails to respond with IP address	<p>Device looks for configured IP address saved in FLASH</p> <ul style="list-style-type: none"> ● Device uses IP address saved in FLASH ● Device checks for configuration (runtime) parameters <ul style="list-style-type: none"> ● If configuration (runtime) parameters EXIST in FLASH, <p>Device uses configuration parameters. Device is operational.</p> ● If configuration (runtime) parameters do NOT exist in FLASH, <p>Device uses default configuration parameters and is operational.</p> <p>Note: Default parameters may not be appropriate for your system.</p>
Device fails to find IP address in FLASH	<p>Device uses a default IP address derived from the device's MAC address</p> <ul style="list-style-type: none"> ● Device is in Safe I/O mode. <p>I/Os are not operational.</p>

Using the Momentum 170ENT11001 Embedded Web Pages

4

At a Glance

Purpose

There are two methods of accessing the Momentum 170ENT11001 either through the Web pages or through the registers using Modbus TCP/IP. This material describes accessing the adapter through Web pages.

The Momentum 170ENT11001 embedded Web pages enable you to:

- Set or retrieve the adapter's configuration using Embedded Configuration Web Pages
- View properties using Embedded Properties Web Pages
- Monitor system status using Embedded Diagnostics Web Pages

Accessing the adapter through the Web pages provides a friendlier GUI for configuration, but most of those same configuration parameters may be accessed through the registers using Modbus TCP/IP. See the chapter, *Accessing the Momentum 170ENT11001 through the Registers*, p. 61.

What's in this Chapter?

This chapter contains the following sections:

Section	Topic	Page
4.1	Navigating the Momentum 170ENT11001 through Embedded Web Pages	38
4.2	Configuring the Momentum 170ENT11001 through the Embedded Web Pages	50

4.1 Navigating the Momentum 170ENT11001 through Embedded Web Pages

At a Glance

Purpose

This material describes accessing and configuring the Momentum 170ENT11001 through the following embedded Web pages found on the Home page.

- Security
- Momentum I/O Properties
- Configure Momentum I/O
- Momentum I/O Diagnostics

After accessing the device, you should configure the configuration (runtime) parameters. A following section describes configuring the configuration parameters.

What's in this Section?

This section contains the following topics:

Topic	Page
Accessing the Momentum 170ENT11001 through the Entry and Home Pages	39
Controlling Web Page Access with Passwords	43
Viewing the Momentum 170ENT11001 I/O Properties	45
Using the Momentum 170ENT11001 Configuration Web Pages	46
Accessing the Momentum 170ENT11001 Diagnostics	48

Accessing the Momentum 170ENT11001 through the Entry and Home Pages

Overview

This unit describes—in table format—the embedded Web pages used to navigate through for the Momentum 170ENT11001.

Entry Page - Momentum I/O Web Server

The welcome page which is named the **Momentum I/O Web Server** page.



Momentum I/O Web Server

(170 ENT 110 01)

[Momentum I/O Configuration and Diagnostics](#)

[Francais](#) | [Deutsch](#) | [Espanol](#)

Operating System: Windows NT

Screen Resolution: 1024 x 768

Browser: Microsoft Internet Explorer 4

Schneider Automation Inc., © 1998-2002

The Home page is named *Momentum I/O Web Server* (index.html) and contains the link—*Momentum I/O Configuration and Diagnostics*. This user guide and the software are translated from English into French, German, and Spanish. Three other links appear on the Home Page. Those links go to the other languages. The link on the *Momentum I/O Web Server* page.

Link	Description
Momentum I/O Configuration and Diagnostics	Accesses a page also named <i>Momentum I/O Web Server</i> (index_1.html) after you supply a password. From this page you access all the functions of the embedded Web pages.

To access the *Momentum I/O Configuration and Diagnostics* page, you must supply a Web Access password in the **Enter Network Password** dialog box.



Enter Network Password ? X

Please type your user name and password.

Site: 192.168.1.2
Realm: ENT_security

User Name: USER
Password: ****

Save this password in your password list

OK Cancel

Unless you configured your own Web Access user name and password from the security page, the default values should be used. Default is USER/USER

1. Type the default user name: **USER** (capitalized) in the **User Name** field.
2. Type the default password: **USER** (capitalized) in the **Password** field.

Note: About passwords

- The maximum length for a password is 16 characters.
- Web Access user names and passwords are case sensitive.
- Schneider Automation does NOT record passwords. Schneider Automation recommends that you record your password.

Home Page - Momentum I/O Web Server

The **Momentum I/O Web Server** page with five links. This page becomes the new home page after entering a password.



Momentum I/O Web Server

[Home](#)

[Security](#)

[Momentum I/O Properties](#)

[Configure Momentum I/O](#)

[Momentum I/O Diagnostics](#)

[Support](#)

FactoryCast™, Schneider Automation Inc., © 1998-2002 v1.0

The links on the *Momentum I/O Web Server* (index_1.html) page.

Link	Description
Home	Returns to the Home page also named <i>Momentum I/O Web Server</i> page.
Security	Accesses the <i>Change Web and Configuration Passwords</i> page. Make changes to passwords here. Note: Schneider Automation does NOT record passwords. Schneider Automation recommends that you record your password. A confirmation page displays after changing either the Web or configuration passwords.
Momentum I/O Properties	Displays a properties page, <i>Momentum I/O Properties</i> .
Configure Momentum I/O	Displays the <i>Configure Momentum I/O</i> page, which displays four links: <i>Configure IP Parameters</i> , <i>Configure Communication Adapter Parameters</i> , <i>Configure SNMP</i> , and <i>Clear All Configuration Parameters</i> page. Each of the pages provides configuration information.
Momentum I/O Diagnostics	Displays the <i>Momentum I/O Diagnostics</i> page, which displays four links: <i>Ethernet Statistics</i> , <i>Faulty Device Replacement Diagnostics</i> , <i>System Log Diagnostics</i> , and <i>Momentum I/O Values</i> . Most of the pages display information only. You may make changes on some pages.
Support	Displays the <i>Contacting Schneider Automation</i> page.

**Page -
Contacting
Support**

Contact Schneider Electric where information is available online.

Assistance Needed	Contact
Technical Information	Visit the Schneider Automation Web site. http://public.modicon.com/newhome/Default.htm
Technical Assistance	customercentral@schneiderautomation.com
Feedback	feedback@modicon.com

Controlling Web Page Access with Passwords

Overview

This section describes the embedded Web page used to enable both Web site security (Web Access Password) and configuration security (Configuration Password) for the Momentum 170ENT11001.

Page - Security

Use this page to make changes.

Change Web Access Password:	
Enter New Web Access User Name:	<input type="text" value="User Name"/>
Enter New Web Access Password:	<input type="password"/>
Confirm New Web Access Password:	<input type="password"/>
Change Configuration Password:	
Enter New Configuration Password:	<input type="password"/>
Confirm New Configuration Password:	<input type="password"/>
Configuration Password:	<input type="password"/> <input type="button" value="Save"/>

You may change both your Web site password and the configuration password. Select the link called **Security** and the *Change Web Access & Configuration Passwords* page appears.

Note: The maximum length for a password is 16 characters.

Configuring the Web Access Password,

Step	Action
1	Enter your Web Access user name.
2	Enter your new password in the Enter New Web Access Password field.
3	Confirm your password.
4	Enter the configuration password. Default is (httpcfguser)
5	Click Save.
6	To confirm a successful change, the <i>Web Access Password Change Confirmation</i> page appears.

Configuring a configuration password,

Step	Action
1	Enter your new configuration password in the Enter New Configuration Password field.
2	Confirm your password.
3	Enter the configuration password. Default is (httpcfguser).
4	Click Save.
5	To confirm a successful change, the <i>Configuration Password Change Confirmation</i> page appears.

Note: DEFAULT CONFIGURATION PASSWORD
The Schneider Electric default configuration password is **httpcfguser** (lower case).

Viewing the Momentum 170ENT11001 I/O Properties

Overview

This unit describes the I/O properties for the Momentum 170ENT11001 using the Momentum I/O Properties Web page.

Page - Momentum I/O Properties

The page provides information only. Select one of the five links at the bottom of the screen to move to another page. This table describes the fields on the *Momentum I/O Properties* page.

Field	Description
Momentum Communication Adapter Status	Provides information about the status (Module Health) and stopped code
Momentum I/O Module Attributes	Provides I/O base information on the number of: <ul style="list-style-type: none"> ● Status Words ● Input Words ● Parameter Words ● Output Words
Communication Adapter	Provides information about the Kernel version and Exec version
Momentum I/O Drop	Provides the adapter's part and serial number and the base's part number

Use this page to select properties.

Momentum I/O Properties

Momentum Communication Adapter Status:	
Module Health:	<input type="text" value="Running"/> Stopped Code: <input type="text" value="0x8000"/>
	0x8000 = Healthy 0x0000 = Not Healthy
Momentum I/O Module Attributes:	
Address-Range	
Status Words:	<input type="text" value="None"/>
Input Words:	<input type="text" value="400001-400001"/>
Parameter Words:	<input type="text" value="None"/>
Output Words:	<input type="text" value="400101-400101"/>
Communication Adapter:	Momentum I/O Drop:
Kernel Version: <input type="text" value="1.00"/>	Adapter Part Number: <input type="text" value="170-ENT-110-01"/>
Exec Version: <input type="text" value="1.00"/>	Adapter Ser.Number: <input type="text" value="31022513579"/>
	Base Part Number: <input type="text" value="170-ADM-350-1x"/>

Using the Momentum 170ENT11001 Configuration Web Pages

Overview

This section describes accessing the configuration (runtime) parameters of the Momentum 170ENT11001.

Page - Configure Momentum I/O

Use this page to select links.



Configure Momentum I/O

[Configure IP Parameters](#)

[Configure Communication Adapter Parameters](#)

[Configure SNMP](#)

[Clear All Configuration Parameters](#)

[Home](#) | [Momentum I/O Properties](#) | [Momentum I/O Diagnostics](#) | [Security](#) | [Support](#)

Note: DEFAULT CONFIGURATION PASSWORD

The Schneider default configuration password is **httpcfguser** (lower case).

Access the Momentum 170ENT11001 configuration pages from this page. There are four links, and each link accesses a configuration page where you change the Momentum 170ENT11001's parameters. When either saving or applying a configuration change, you will be asked to supply the configuration password.

Link	Description
Configure IP Parameters	Configure the following IP Address related parameters: <ul style="list-style-type: none"> ● Role Name ● IP Address ● Subnet Mask ● Gateway ● Framing Type ● Fall Back to Stored IP Parameters in the absence of an address server
Configure Communication Adapter Parameters	Configure the application level parameters of the Momentum 170ENT11001: <ul style="list-style-type: none"> ● I/O Configuration <ul style="list-style-type: none"> ● Reservation Time ● Holdup Time ● Masters IP Addresses <ul style="list-style-type: none"> ● Master1 IP ● Master2 IP ● Master3 IP ● Fall Back to Stored Application Parameters in the absence of an FDR server <p>The behavior of all of these parameters, except Reservation Time, is modeled after the Momentum 170ENT11000.</p>
Configure SNMP	Edit the SNMP configuration information. Current configuration information displays on this page. Changes apply to the module's SNMP configuration database. Reboot the module to affect the runtime parameters. You may configure the following parameters: <ul style="list-style-type: none"> ● Manager's IP Address ● Agent ● Community ● Security
Clear All Configuration Parameters	Selecting this option clears from Flash all the configuration parameters listed in the preceding three rows.

Complete descriptions of the **Configure IP Parameters**, **Configure Communication Adapter Parameters**, **Configure SNMP**, and **Clear All Configuration Parameters** pages appear in the section called *Using the Momentum 170ENT11001 Configuration Web Pages*.

Accessing the Momentum 170ENT11001 Diagnostics

Overview

This section describes the links on the Momentum I/O Diagnostics Web page.

Page - Momentum I/O Diagnostics

Use this page to select diagnostics.



Momentum I/O Diagnostics

[Ethernet Statistics](#)

[Faulty Device Replacement Diagnostics](#)

[System Log Diagnostics](#)

[Momentum I/O Values](#)

Home | [Momentum I/O Properties](#) | [Configure Momentum I/O](#) | [Security](#) | [Support](#)
FactoryCast™, Schneider Automation Inc., © 1998-2002 v1.0

The Momentum I/O Diagnostics page has four links.

Link	Description
Ethernet Statistics	<p>Monitor each Ethernet module, receive/transmit statistics, and check functioning error. All fields are read-only.</p> <p>Device information:</p> <ul style="list-style-type: none"> ● IP Address ● Subnet Mask ● Default Gateway Address ● MAC Address ● RoleName <p>Ethernet statistics reported</p> <ul style="list-style-type: none"> ● counters for various Ethernet-based statistics <p>Counters may be reset.</p>
Faulty Device Replacement Diagnostics	<p>This page displays the following information:</p> <ul style="list-style-type: none"> ● FDR Client Status ● Stored Parameters equal to FDR Server Parameters ● Current Parameters equal to Stored Parameters ● DHCP Attempts ● Automatic Backups ● FTP Connection Errors ● FTP Backup/Restore Errors <p>Counters may be reset.</p>
System Log Diagnostics	<p>This page displays system status information. When clicking this link one of two pages open.</p> <ul style="list-style-type: none"> ● No entries in System Log ● System Log File <p>System log may be cleared.</p>
Momentum I/O Values	<p>Displays I/O register values in read-only format. These internal registers are mapped to emulate 4xxxxx registers.</p>

4.2 Configuring the Momentum 170ENT11001 through the Embedded Web Pages

At a Glance

Purpose

This material describes configuring the configuration parameters through the embedded Web pages.

You should configure the configuration parameters for your automation environment and system.

Configuring the Device—Using Embedded Web Pages

Selecting the Configure Momentum I/O link displays a page with four links to the following pages..

Link Selected	Opens
Configure IP Parameters	<i>Current IP Configuration page</i>
Configure Communication Adapter Parameters	<i>Current Communication Adapter Configuration page</i>
Configure SNMP	<i>Current SNMP Configuration page</i>
Clear All Configuration Parameters	<i>Clear All Configuration Parameters page</i>

Note: The embedded Web pages are not available on the Momentum 170ENT11000 or 170ENT11002 communication adapters.

The following sections describe the pages listed in the preceding table.

What's in this Section?

This section contains the following topics:

Topic	Page
Configuring the Momentum 170ENT11001 IP Parameters	51
Configuring the Momentum 170ENT11001 Communication Adapter Parameters	54
Configuring the Current SNMP Configuration	57
Clearing the Momentum 170ENT11001 Configuration Parameters	59

Configuring the Momentum 170ENT11001 IP Parameters

Overview

This unit describes the embedded Web pages that allow you to change the configuration parameters.

Changing the Current IP Configuration

This page allows you to specify the IP parameters and to provide parameters to be used in the event of a FDR/BOOTP/DHCP server not being available.

Current IP Configuration

RoleName:	<input type="text"/>		
IP Address:	<input type="text"/>	Subnet Mask:	<input type="text"/>
Gateway:	<input type="text"/>	Framing Type:	<input type="text" value="Auto Framing"/>
<input type="checkbox"/> Fall Back to Stored IP Parameters in the absence of an address server.			
Configuration Password:	<input type="text"/>	<input type="button" value="Update Stored Values"/>	

Note: DEFAULT CONFIGURATION PASSWORD

The Schneider Electric default configuration password is **httpcuser** (lower case).

The *Current IP Configuration* page permits configuring the following IP Address parameters:

- RoleName
- IP Address
- Subnet Mask
- Gateway
- Framing Type
- Fall Back to Stored IP Parameters in the absence of an address server

One check box appears on this page.

Check box name	Description
Fall Back to stored IP parameters in the absence of an address server.	If the device can not get parameters from an FDR Server then the device will use stored parameters when check box is "checked" else the device will go to SAFE IO mode (I/O disable).

The first three command buttons change the view, and the fourth command button carries out the changes made to the parameters.

Button Selected	Result
Display Stored	Reread the page and display the Stored Values, the values in the FLASH.
Display Current	Reread the page with Current Values, the values in the RAM.
Display Factory Defaults	Reread the page and display the Factory Defaults.
Update Stored Values	<p>Make changes to any of the fields.</p> <ol style="list-style-type: none"> 1. Enter the configuration password (httpcfguser). 2. Click the Update Stored Values button. 3. Changes are stored in RAM and FLASH and in the FDR server (if using FDR).

Changing RoleNames

If the RoleName is changed, a corresponding confirmation page appears.

- *RoleName Change Confirmation* page

You **MUST** reboot after a RoleName change.

Note: If you have further configuration (runtime) changes to make, Schneider Electric recommends that you make configuration (runtime) parameter changes first and then change the RoleName

After all changes are made, click Reboot Now.

RoleName Change Confirmation

RoleName has been changed. System Reboot is required.

Reboot Now

Home | Momentum I/O Properties | Configure Momentum I/O | Momentum I/O Diagnostics | Support
Schneider Automation Inc., © 1998-2002

There are three important facts about RoleNames:

- After a RoleName change, you **MUST** reboot the device. Click the **Reboot Now** button.
 - RoleNames are case sensitive.
 - Valid characters are [a ... z], [A ... Z], [0 ... 9], and [underscore].
-

Changing IP Parameters

The system displays an **IP Change Confirmation** page. You may reboot the system, or you may click **Cancel** and continue working.

Note: If you choose to continue working, your IP parameter changes will not take effect until after the next reboot.

Schneider Automation recommends that you reboot by clicking **Reboot Now**. Reboot on the IP Change Confirmation page.

IP Change Confirmation

One of the IP Parameters has been changed.

The new parameters will NOT take effect until after the system reboots

Would you like to reboot now?

Reboot Now

Cancel

Home | Momentum I/O Properties | Configure Momentum I/O | Momentum I/O Diagnostics | Support
Schneider Automation Inc., © 1998-2002

- *IP Change Confirmation* page

The IP Change Confirmation page is used to change these five (5) parameters: *IP Address, Gateway, Subnet Mask, Framing Type, and Fall Back to Stored IP Parameters in the absence of an address server* button.

Reboot is optional but recommended. The new parameters will NOT take effect until the device is rebooted.

Configuring the Momentum 170ENT11001 Communication Adapter Parameters

Overview

This unit describes the embedded Web pages that allow you to change the configuration parameters.

Changing the Current Communication Adapter Parameters

Configure the configuration (runtime) parameters of the Momentum 170ENT11001 on this page.

Current Communication Adapter Configuration

I/O Configuration:	
Reservation Time: <input type="text" value="6000"/> x10msec	<u>Valid Range</u> 30 - 6000
Holdup Time: <input type="text" value="100"/> x10msec	<u>Valid Range</u> 0=indefinite. 30 - 6000
Masters IP Addresses:	
Master1 IP:	<input type="text"/>
Master2 IP:	<input type="text"/>
Master3 IP:	<input type="text"/>
<input type="checkbox"/> Fall Back to Stored Application Parameters in the absence of an FDR server	
Configuration Password: <input type="text"/>	<input type="button" value="Apply"/> <input type="button" value="Save"/>

Note: DEFAULT CONFIGURATION PASSWORD
The Schneider Electric default configuration password is **httpcfguser**
(lower case).

The *Current Communication Adapter Configuration* page permits configuring the following configuration (runtime) parameters by entering values in the appropriate fields:

- I/O Configuration
 - Reservation Time (Default: 6000 (60 seconds))
 - Holdup Time (Default: 100 (1 second))
- Masters IP Addresses
 - Master1 IP
 - Master2 IP
 - Master3 IP

Specify up to 3 IP address to which write privileges will be granted.

- Fall Back to Stored Application Parameters in the absence of an FDR server

Summarizing the Communication Adapter Parameters

The Reservation Time, Holdup Time, and Masters IP Addresses are accessible through the embedded Web pages or by accessing the registers using Modbus TCP/IP. For a discussion of these registers, see the section *Accessing the Momentum 170ENT11001 through the Registers*, p. 61.

	WARNING
	<p>LOSS OF COMMUNICATION — INDEFINITE HOLDUP TIME</p> <p>If indefinite Holdup Time is selected, and communication is lost between the controller and the Momentum 170ENT11001, the I/O outputs will hold last value written until communication is reestablished.</p> <ul style="list-style-type: none"> ● Configure the controller to periodically read the I/O module health (Word 10) of the System Status Block, register 4F801 hex, of the Momentum 170ENT11001 to verify that the communication between the controller and the Momentum 170ENT11001 is operational and that the controller is healthy. ● The System Status Block is described in the System Status Block Table in the Using the Status Group Registers (See <i>System Status Block</i>, p. 69) section. <p>Failure to follow this precaution can result in death, serious injury, or equipment damage.</p>

Using the Check Box

Under the Masters IP Addresses area, one check box appears on this page. This check box pertains to using the FDR service.

Check Box Name	Description
Fall Back to Stored Application Parameters in the absence of an FDR server	<p>When booting up, this check box informs the device of the expected behavior when an FDR server is not available.</p> <p>If an FDR server is not available when device is booting up, and</p> <ul style="list-style-type: none"> ● Check box IS selected (checked): <ul style="list-style-type: none"> ● Device uses stored parameters. ● Check box is NOT selected (not checked): <ul style="list-style-type: none"> ● Device goes to Safe I/O mode

Using the Web Page Command Buttons

Five command buttons carry out the changes made to the parameters.

Button Selected	Result
Display Stored	Reread the page and display the Stored Values, the values in the FLASH.
Display Current	Reread the page with Current Values, the values in the RAM.
Display Factory Defaults	Reread the page and display the Factory Defaults.
Apply	<p>Store the parameters displayed on the page into the</p> <ol style="list-style-type: none"> 1. current values in RAM <p>The Apply button will NOT change either the contents of FLASH (nonvolatile memory) or the contents of the FDR server.</p> <p>If the change is successful, you will see the <i>Communication Adapter Apply Confirmation</i> page displaying this message, "Configuration applied successfully."</p> <p>If the change is NOT successful, an error message displays. Refer to the system log page for additional information.</p>
Save	<p>Store the parameters displayed on the page into</p> <ol style="list-style-type: none"> 1. FDR server (if using FDR), and 2. FLASH (nonvolatile memory), and 3. current values in RAM <p>The Save button WILL change the contents of FLASH and the contents of the FDR server.</p> <p>If the change is successful, you will see the <i>Communication Adapter Save Confirmation</i> page displaying this message, "Configuration saved successfully."</p> <p>If the change is NOT successful, an error message displays. Refer to the system log page for additional information.</p>

Configuring the Current SNMP Configuration

Overview

This unit describes the embedded Web page that allows you to view and change the SNMP configuration parameters.

Changing Current SNMP Configuration

Edit the SNMP configuration information on this page. Upon accessing this page the user will see the current configuration information. Any changes will only be applied to the module's SNMP configuration database and will not take effect as the runtime parameters until after the module has been rebooted.

Make changes on this page.

Current SNMP Configuration

System Name: 170-ENT-110-01	
System Description: Momentum I/O TCP/IP Communications Module	
Managers IP Address:	
Manager I: <input type="text"/>	Manager II: <input type="text"/>
Agent:	
Location [SysLocation]:	<input type="text"/>
Contact [SysContact]:	<input type="text"/>
Community:	
Set: <input type="text" value="Private"/>	
Get: <input type="text" value="Public"/>	<input type="checkbox"/> Authentication Failure Trap Enabled
Trap: <input type="text" value="Public"/>	
Configuration Password: <input type="text"/>	<input type="button" value="Update SNMP"/>

Note: DEFAULT CONFIGURATION PASSWORD

The Schneider Electric default configuration password is **httpcfguser** (lower case).

The *Current SNMP Configuration* page permits configuring the following parameters:

- Managers IP Addresses
 - Manager I
 - Manager II

 - Agent
 - Location (SysLocation)
255-character string describing the physical location of the node
 - Contact (SysContact)
255-character string describing the identification and contact information for the contact person for this managed node

 - Community
Community names determine the level of permission given to each of the available actions. Set distinct community names for each of the following actions:
 - Set (default is **private**)
Enables the management station to set the value of object at the agent
 - Get (default is **public**)
Enables the management station to retrieve the value of object from the agent
 - Trap (default is **public**)
Enables an agent to notify the management station of significant events
-

Using the Check Box

One check box appears on this page.

Check Box Name	Description
Authentication Failure Trap Enable	Signifies that the sending protocol entity is the addressee of a protocol message that is not properly authenticated. While implementations of the SNMP must be capable of generating this trap, they must also be capable of suppressing the emission of such traps via an implementation-specific mechanism.

Using the Web Page Command Buttons

Two command buttons carry out the changes made to the parameters.

Button Selected	Result
Reset The Form	Clears the page.
Update SNMP	Update the module's SNMP configuration database. For these changes to take affect, reboot the module. If the change is successful, the user will see the <i>SNMP Update Confirmation</i> page displaying this message, "SNMP Configuration updated successfully."

Clearing the Momentum 170ENT11001 Configuration Parameters

Clearing All the Configuration Parameters

Use the **Clear All Configuration Parameters** page to clear all configuration parameters stored in FLASH.

The parameters cleared from Flash are

- All IP configuration parameters and the RoleName
- All communication adapter configuration parameters
- All SNMP configuration parameters
- All stored passwords

Enter a password in the **Configuration Password:** text box. Select **Clear All**.

Note: DEFAULT CONFIGURATION PASSWORD

The Schneider Electric default configuration password is **httpcuguser** (lower case).

Purpose of Clear All button

Button Selected	Result
Clear All	Clears all the parameters in the Momentum 170ENT11001.

Before completing the action a warning message appears.

- **IMPORTANT:** If you continue, all the configuration parameters will be cleared to the **FACTORY DEFAULT CONFIGURATION** and the communications adapter will **REBOOT**. Press **OK** to continue. Press **Cancel** to abort this operation.

Note: FACTORY DEFAULT CONFIGURATION

Selecting the Clear All option returns the Momentum 170ENT11001 to an out-of-the-box state, which is the factory default configuration.

Enter configuration password, and click Clear All.

Clear All Configuration Parameters

**All configuration parameters will be cleared to the
FACTORY DEFAULT CONFIGURATION
and the communications adapter will
REBOOT.**

Configuration Password: <input type="password" value="*****"/>	<input type="button" value="Clear All"/>
--	--

[Home](#) | [Security](#) | [Configure Momentum I/O](#) | [Momentum I/O Properties](#) | [Momentum I/O Diagnostics](#) |
Schneider Automation Inc., © 1998-2002

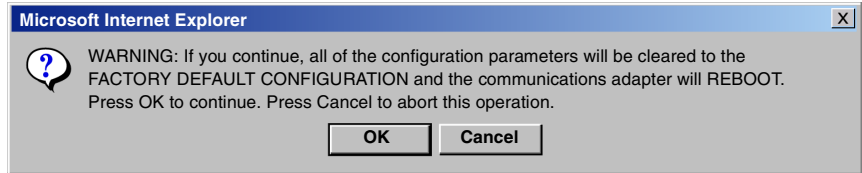

Accessing the Momentum 170ENT11001 through the Registers

5

At a Glance

Purpose

There are two methods of accessing the Momentum 170ENT11001 either through the Web pages or through registers. This section describes accessing the adapter through the registers using Modbus TCP/IP.

The adapter contains three groups of internal registers that enable the adapter to

- Transfer input or output data at the I/O base adapter's field terminals using Data Group Registers
The Data Group Registers are accessible only through Modbus TCP/IP.
- Set or retrieve the adapter's configuration using Configuration Group Registers
- Monitor system status using Status Group Registers

To read from inputs or write to outputs, you must access the adapter's Data Group Registers through Modbus TCP/IP.

What's in this Chapter?

This chapter contains the following topics:

Topic	Page
Understanding the Internal Registers	62
Using the Data Group Registers	64
Configuring Parameters through the Configuration Group Registers	65
Using the Status Group Registers	69

Understanding the Internal Registers

Overview

This section describes configuring a Momentum 170ENT11001 using the Modbus TCP/IP protocol.

Background

The adapter contains three groups of internal registers that enable the adapter to:

- Transfer input or output data at the I/O base adapter's field terminals
Data Group Registers
- Set or retrieve the adapter's configuration
Configuration Group Registers
- Monitor system status
Status Group Registers

All three register groups can be accessed as 4x (400) references by MSTR function blocks over the Ethernet network by standard Modbus commands to ensure compatibility with existing devices.

The user can access various registers to obtain I/O module information via the Ethernet network. These internal registers are mapped to emulate 4x (400) registers allowing read/write 4x (400) register commands to be used for example by using a MSTR block.

Those same registers can be accessed through the Web pages as discussed in the section, *Accessing the Momentum 170ENT11001 through Embedded Web Pages*. Accessing through the Web pages provides a friendlier GUI for configuring the registers.

Following is a diagram that shows the data flow between the Ethernet network and the Ethernet Communication Adapter's internal registers.

Data Flow Diagram

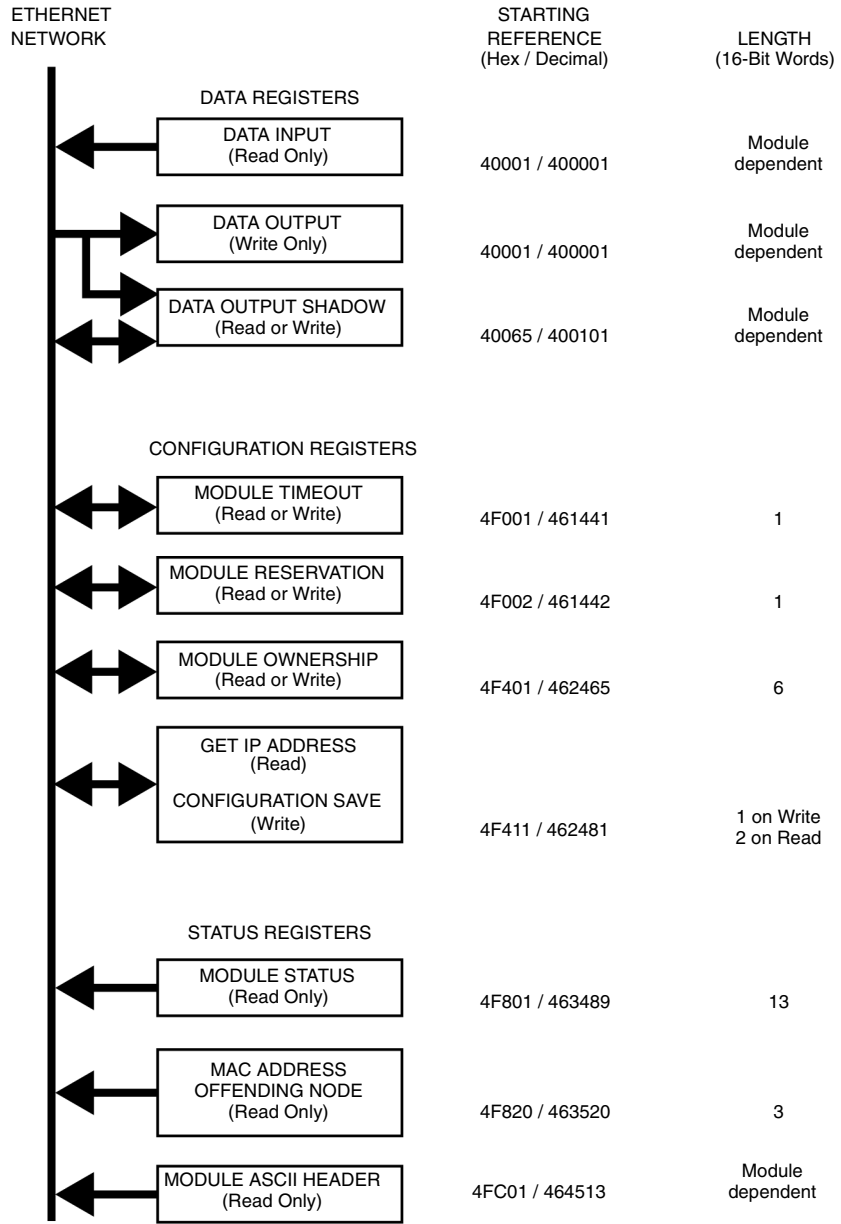

Using the Data Group Registers

Overview

This section describes the data group registers. The data group registers can be accessed only through Modbus TCP/IP.

Data Group Registers

Register Name:

Data Inputs/Outputs		
Web page that accesses register	Register as seen through Modbus TCP/IP	
<i>Momentum I/O Values</i> page	40001 hex	400101 (shadow)
The input buffer scheme captures a snapshot of all input data.		
The output buffer scheme insures that the newest copy of output data is written to the output modules. A special algorithm is also used to insure old data is not lost, during a single word update of a multiple word output buffer field.		
New in the Momentum 170ENT11001's output registers are shadow registers that allow Read/Write access of I/O data at 400101. The result of writing to 400101 is the same as writing to 400001.		
Starting reference 400001 is used to address input data from field inputs and output data to field outputs. Data is transferred in the IEC format. Mapping between the controller's data registers and I/O base field terminals is unique to each base, and the mapping is described in the <i>Momentum I/O Bases User Guide</i> , 870USE00200.		
At 400101 there are a set of registers that shadow the 400001 output register. You may read and writer your output data to this shadow register, and the result of writing to 400101 is the same as writing to 400001.		

Configuring Parameters through the Configuration Group Registers

Overview

This section describes configuring a Momentum 170ENT11001 using the Modbus TCP/IP protocol.

Configuration Group Registers

The Configuration group contains four registers that are used by the adapter:

- Outputs Holdup Timeout Value register
- Ownership of Write Privilege register
- Reservation Time register
- Configuration Save/Get Current IP Address register

A block of registers in this area is reserved for use by distributed I/O.

Register Name:

Outputs Holdup Timeout Value	
Web page that accesses register	Register as seen through Modbus TCP/IP
<i>Configure Communication Adapter Parameters</i> page	4F001 hex
Reference 4F001 specifies the amount of time that outputs will be held in their current state if they are not updated by a new Modbus TCP/IP Write. If the module's holdup time expires before a new Modbus TCP/IP Write is received, all outputs are set to logical 0 (zero). The field length is one word. The timeout value is expressed in units of 10 milliseconds. Valid values are either 0 (zero) or a range of 30 (300 milliseconds) through 6000 (60 seconds). The default value is 100 (1 second).	
Note: The value of 0 (zero) in this register indicates an indefinite holdup time, and the outputs will not change if they are not updated by a Modbus TCP/IP Write.	
The register's contents can be read using a Modbus TCP/IP Read.	
You can store this parameter in FLASH. Reference Configuration Save .	

	<p>WARNING</p>
	<p>LOSS OF COMMUNICATION — INDEFINITE HOLDUP TIME</p> <p>If indefinite Holdup Time is selected, and communication is lost between the controller and the Momentum 170ENT11001, the I/O outputs will hold last value written until communication is reestablished.</p> <ul style="list-style-type: none"> ● Configure the controller to periodically read the I/O module health (Word 10) of the System Status Block, register 4F801 hex, of the Momentum 170ENT11001 to verify that the communication between the controller and the Momentum 170ENT11001 is operational and that the controller is healthy. ● The System Status Block is described in the System Status Block Table in the section <i>System Status Block</i>, p. 69. <p>Failure to follow this precaution can result in death, serious injury, or equipment damage.</p>

Registers follow a logical order, but here the Ownership of Write Privilege register discussion is presented before the Reservation Time discussion because understanding ownership of write privileges helps to understand the function of reservation time.

Register Name:

Ownership of Write Privilege	
Web page that accesses register	Register as seen through Modbus TCP/IP
<i>Configure Communication Adapter Parameters</i> page	4F401
Once the adapter's reservation timer has expired, it will give sole write privilege to the first node that writes to the adapter using the Modbus TCP/IP Write. The adapter maintains an internal timer for handling the write privilege. The timer will reserve sole privilege to that node as long as the node continues to write to the adapter within the reservation time.	
The Ownership register is used so that more than one Modbus device can have write access to the Ethernet Communication Adapter. Up to three remote devices can have write access at the same time. This special case overrides the reservation time limit. The ownership register is six words starting at location 4F401, two words for the IP address of each device. The default setting for each ownership register is null (no owner). Register 4F401 contains the first owner's IP address, register 4F403 the second owner's IP address, and 4F405 contains the third owners IP address. All three owners have the same write privileges. The ownership registers can be stored in the non-volatile or FLASH. With those addresses stored, any of those three nodes may then write to the adapter in addition to the original privileged node. This allows up to four nodes to concurrently own write privilege to the adapter.	
Two types of times: Note that this reservation time is separate from the Outputs Holdup time and applies only to the write privilege.	
Any node may read the input data or status information from the adapter.	
You can store this parameter in FLASH. Reference Configuration Save .	

Register Name:

Reservation Time	
Web page that accesses register	Register as seen through Modbus TCP/IP
<i>Configure Communication Adapter Parameters</i> page	4F002
The Ethernet Communication Adapter is dedicated to one Ethernet device. Reservation timeout is	
<ul style="list-style-type: none"> Amount of time (Default = 60 seconds) that the output module will be dedicated to an Ethernet device that is no longer communicating with that adapter The range is 30 (300 milliseconds) through 6000 (60 seconds). If the timeout expires, this unit will be dedicated to the next device that writes to the adapter.	
You can store this parameter in FLASH. Reference Configuration Save .	

Register Name:

Configuration Save/Get Current IP Address	
Web page that accesses register	Register as seen through Modbus TCP/IP
<i>Configure Communication Adapter Parameters</i> page and <i>Configure IP Parameters</i> page	4F411 hex
Modbus TCP/IP Write: Configuration Save	
This reference serves a dual purpose, depending on whether the application issues a Modbus TCP/IP Write or a Modbus TCP/IP Read. When the register issues a Modbus TCP/IP Write the register name is Configuration Save, and when the register issues a Modbus TCP/IP Read the register name is Get Current IP Address.	
For a Modbus TCP/IP Write the reference is treated as a one-word register, with the application writing one word of data. The Modbus TCP/IP Write data may consist of a value from 0 (zero) to 15, a bit-masked OR (the Boolean logical "OR").	
If a data 1 (one) is written to the reference, the adapter will save its currently assigned IP address to FLASH. If a new initialization occurs and the adapter cannot find a BOOTP server, the adapter will use this saved address.	

The configuration register values for the 4F411 hex register: Modbus TCP/IP Write ONLY.

Register	Register Decimal Value	Register Binary Value	Action
4F411 hex	0	0000	Clears the configuration in Flash: Cleared are the configured IP parameters, the three (3) Master IP addresses, the outputs holdup timeout value, and the reservation time values.
	1	0001	Saves the configured IP to FLASH
	2	0010	Saves the three (3) Master IPs addresses to FLASH
	4	0100	Saves the Outputs Holdup Timeout Value to FLASH
	8	1000	Saves the Reservation Time to FLASH

Example: If you want to save Reservation Time, Outputs Holdup Timeout Value, and Save the configured IP to FLASH:

1. Add the register decimal values:

$$1 + 4 + 8 = 13$$

2. Enter the decimal value **13** into the register

3. The value displays in binary:

00001101

Register Name:

Configuration Save/Get Current IP Address	
Web page that accesses register	Register as seen through Modbus TCP/IP
<i>Configure IP Parameters</i> page	4F411 hex
Modbus TCP/IP Read: Get Current IP Address	
This reference serves a dual purpose, depending on whether the application issues a Modbus TCP/IP Write or a Modbus TCP/IP Read. When the register issues a Modbus TCP/IP Write the register name is Configuration Save, and when the register issues a Modbus TCP/IP Read the register name is Get Current IP Address.	
For a Modbus TCP/IP Read the reference is treated as a two-word register, with the application reading two words of data. If the adapter has IP parameters saved in its non-volatile, FLASH, it will return its current IP address to the Modbus TCP/IP Read, indicating that it has stored parameters. If IP parameters are not currently saved, the adapter returns all ones (FFFFFFFF hex) to the Read.	

Using the Status Group Registers

Overview

This section describes the two register blocks in the Status Group:

- Status Block
- ASCII Header Register Block

More than one register is referred to as a block.

System Status Block

The registers in this group provide information about the module's revision level and current operating parameters. These registers are Read-Only. The module status block starts at offset 4F801(hex).

Words of Information	Description	Value
Word 1	Length of status block (words)	Max. of 13 words
Word 2	Number of I/O module input words	Module dependent
Word 3	Number of I/O module output words	Module dependent
Word 4	I/O module ID number	Module dependent
Word 5	Communication Adapter revision number	Format: XR Where: <ul style="list-style-type: none"> ● X = upper 4 bits, always 0000 ● R = lower 12 bits, defining the revision as 3 hex characters Example: <ul style="list-style-type: none"> ● 100 hex = Rev. 1.00 ● 200 hex = Rev. 2.00
Word 6	ASCII header length in words	Module dependent
Word 7	Last IP address to communicate with this adapter in most recent Modbus transaction (low word of 2 words) See 4F80D.	Node address dependent
Word 8	Remaining ownership reservation time	Milliseconds
Word 9	Remaining output holdup time	Milliseconds
Word 10	I/O Module health	8000 hex = healthy 0000 hex = not healthy
Word 11	I/O module last error counter	Module dependent
Word 12	I/O module error counter	Error count 0000 FFFF hex
Word 13	Last IP address to communicate with this adapter in most recent Modbus transaction (high word of 2 words) See 4F807.	Node address dependent

**MAC Address
Offending Node
Block**

The MAC address of the offending node will be saved in the 4F820 register area (non volatile) memory. Read the 4F820 register to use the stored information for analysis. Remember that the Momentum 170ENT11001 will be at its default address since the adapter returns to its default IP. Connect to the 170ENT11001 using its default IP address. To establish the default IP, see the appendix, *Deriving an IP Address from a MAC Address*. You may need to add a route to your computer, to complete this process, see the appendix, *Establishing an Active Route - Momentum 170ENT11001*.

**ASCII Header
Block**

The ASCII header block starts at offset 4FC01. These registers contain an ASCII text description of the module. These registers are Read-Only. The block length depends upon the type of I/O base to which the adapter is connected. The maximum length is 64 bytes of ASCII characters, which corresponds to a length of eight (8) 32-words as specified in word 6 of the Module Status Block (at reference 4F806). The block contains labels to identify quantities of input and output words, and the ID code of the I/O base. The block contents can be parsed by an application program to extract this information.

Status Block Parsing

ASCII Characters	Description
Ethernet	Identifies Ethernet Communication Adapter
0x20	Space
IEC	Data is transferred with I/O base in IEC format
0x20	Space
DIG:	Digital module (ID range: XX00 ... XX7F hex)
EXP:	Expert module (ID range: XX80 ... XXBF hex)
ANA:	Analog module (ID range: XXC0 ... XXFE hex)
0x20	Space
Inlen=<i>n</i>	Input words (<i>n</i> = quantity of words, decimal)
0x20	Space
Outlen=<i>n</i>	Output words (<i>n</i> = quantity of words, decimal)
0x20	Space
ID=0xnⁿⁿⁿ	Module DI code (nnnn = ID code, hex)

Using Faulty Device Replacement

6

At a Glance

Purposes

This section covers the Faulty Device Replacement service available on the Momentum 170ENT11001. The Faulty Device Replacement service offers you a method of handling device replacement without disrupting the system nor interrupting service. The Momentum 170ENT11001 supports Faulty Device Replacement only as a client.

What's in this Chapter?

This chapter contains the following topics:

Topic	Page
Understanding Faulty Device Replacement	72
Booting with FDR Enabled	76
Replacing a Faulty Device	78
FDR Run Time	81

Understanding Faulty Device Replacement

About Faulty Device Replacement

Faulty Device Replacement (FDR) configuration is accessible only through the embedded Web pages

FDR with RoleName allows replacement without reconfiguring the device.

Choosing to use FDR depends upon both your automation environment and your needs for replacement capabilities.

Benefits of FDR

Choice	Reason for Using
Using FDR	FDR provides <ul style="list-style-type: none">● technician only needs to know the device's RoleName to replace a faulty device● centralized IP management● centralized storage of configuration (runtime) parameters● configuration parameters are never lost
Not using FDR	No FDR server is available

Using FDR requires assigning a unique RoleName to your Momentum 170ENT11001.

FDR and RoleNames

Inherent in the discussion of Faulty Device Replacement is the idea of a RoleName.

The Momentum 170ENT11001

- With a RoleName runs FDR
- Without a RoleName runs BOOTP

A device that does not have a RoleName does not participate in FDR.

A RoleName is a logical name that you assign to a device, a logical name that has meaning in your application.

Valid RoleNames are alphanumeric and underscore, with a maximum of 16 characters.

Some examples of RoleNames might be

- **ENT_6** (6th Momentum ENT in your application)
- **OUTPUT_VALVE_2** (2nd Output Valve in your application)

<p>Note: The Logical RoleName should be written on the device.</p>

	<p>CAUTION</p>
	<p>UNIQUE ROLENAME</p> <p>A non unique RoleName may cause an DHCP/FDR server to serve a configuration belonging to another device.</p> <ul style="list-style-type: none"> • Ensure that ALL devices have a UNIQUE RoleName. • Ensure that the unique RoleName appears in ONLY ONE (1) DHCP/FDR server table. <p>Failure to follow this precaution can result in injury or equipment damage.</p>

Device Uses a RoleName to Boot Up—FDR Server Responds

The Momentum 170ENT11001 will

Step	Action
1	Transmit DHCP Discover messages to request its IP parameters from the FDR server.
2	<p>If an FDR server responds with an IP address, the Momentum 170ENT11001</p> <ol style="list-style-type: none"> 1. uses the IP parameters received 2. attempts to get its configuration (runtime) parameters from the FDR server <ul style="list-style-type: none"> • configuration parameters ARE served from FDR server: <p>Device uses those configuration parameters and is operational (I/Os are running).</p> • configuration parameters are NOT served from FDR server, and configuration parameters are STORED in FLASH, and ConfigFallBack flag* is SELECTED ("Fall Back to Stored Application Parameters in the absence of an FDR server." check box)*: <p>Device uses configuration parameters and is operational.</p> • configuration parameters are NOT served from FDR server, and configuration parameters are NOT stored, and/or ConfigFallBack flag is NOT selected ("Fall Back to Stored Application Parameters in the absence of an FDR server." check box): <p>Device goes to Safe I/O mode and uses the IP address from FDR server. I/Os are not operational. Blink Code on LAN ST indicator (LED): 8 Flashes.</p> <p>* "Fall Back to Stored Application Parameters in the absence of an FDR server." check box appears on the Current Communication Adapter Configuration Web page.</p>

Device Uses a RoleName to Boot up—FDR Server Does Not Respond

The Momentum 170ENT11001 will

Step	Action
1	Transmit DHCP Discover messages to request its IP parameters from the FDR server.
2	<p>If an FDR server does NOT respond with an IP address, the device</p> <ol style="list-style-type: none"> checks if both IP parameters exist in FLASH and IPFallback flag* is selected ("Fall Back to Stored IP Parameters in the absence of an address server." check box, and if) IP parameters EXIST in FLASH and IPFallback flag is SELECTED: <p>Device uses STORED IP parameters, and checks for configuration (runtime) parameters in FLASH</p> <ul style="list-style-type: none"> configuration parameters EXIST, and ConfigFallback flag** is SELECTED ("Fall Back to Stored Application Parameters in the absence of an FDR server." check box)*: <p>Device uses configuration parameters and is operational.</p> configuration parameters do NOT exist, and/or ConfigFallback flag is NOT selected ("Fall Back to Stored Application Parameters in the absence of an FDR server." check box): <p>Device goes to Safe I/O mode and uses IP address from FLASH. I/Os are not operational. Blink Code on LAN ST indicator (LED): 6 Flashes.</p> IP parameters do NOT exist in FLASH and/or IPFallback flag is NOT selected: <p>Device uses DEFAULT IP parameters and goes to Safe I/O mode. I/Os are not operational. Blink Code on LAN ST indicator (LED): 8 Flashes.</p> <p>* "Fall Back to Stored Application Parameters in the absence of an FDR server." check box appears on the Current Communication Adapter Configuration Web page. ** The check box appears on the Current IP Configuration page. Note: In the absence of a configured RoleName, the Momentum 170ENT11001 will not participate in FDR.</p>

Booting with FDR Enabled

Overview

This section describes how a Momentum 170ENT11001 boots as a replacement for a faulty device.
FDR is accessible only through the embedded Web pages.

Supporting FDR

The Momentum 170ENT11001 will support Faulty Device Replacement (FDR) only as a client.

<p>Note: A Momentum 170ENT11001 needs an FDR server available to function as a client.</p>

Booting with an FDR Device

In this capacity it will be able to retrieve its IP and configuration parameters from a DHCP server and an FTP server respectively. The presence or absence of a Role Name will control participation in an FDR environment—no Role Name, no participation.

"Out of the Box"

In its default, out of the box configuration, the Momentum 170ENT11001 will not have a Role Name present; therefore, it will behave as a Momentum 170ENT11000 device.

Note: A change in the Role Name configuration parameter will require a reboot before it will take effect.

Changing the Role Name may be accomplished using the *Configure IP Parameters* Web page. You will be prompted for the password to approve the required reboot.

Startup after First Configuration

Upon startup, if the Role Name exists, assume that the device is intended to behave as an FDR client. If the Role Name is present, the Momentum 170ENT11001 will attempt to get its IP parameters via DHCP requests. After receiving its IP parameters, the Momentum 170ENT11001 will store the served IP parameters to FLASH. On subsequent boot-ups, if the DHCP/FDR server is not responding and the IPFallback bit is set, the Momentum 170ENT11001 will use these stored parameters to accomplish the boot.

Note: Starting up after the first configuration requires that the adapter make decisions based on a set of rules outlined in two state tables found in the Appendix. For the details of the decision process for selecting IP parameters and configuration file. See:

- IP Parameter Resolution State Table
- Configuration Parameter State Table

Both tables are in the Appendix.

Replacing a Faulty Device

Overview

This section describes replacing a faulty device and how to configure the device after it has been replaced.

FDR configuration is accessible only through the embedded Web pages.

Faulty Device Replacement

The Faulty Device Replacement service offers you an easy method of handling device replacement with minimal disruption of service. Should a device fail, replacing that device is easy. The technician can then get a new device from stores, enter the corresponding RoleName into the device, and place the device in the system. When the new device is physically connected to the network, the system (including the new device) is able to

- Provide the replacement device with the IP address of the previous device
- Ensure that new device is functioning properly
- Restore the I/O device application parameters in order to restart the device with the same configuration as before the failure

Faulty Device Replacement enables you to avoid configuring a new device when a faulty device is replaced.

Faulty Device Replacement is implemented using the combination of DHCP and FTP standard protocols.

Obtaining IP Parameters using FDR

When the device boots up, it attempts to obtain its IP parameters from the FDR server using the DHCP protocol. After receiving its IP parameters, the Momentum 170ENT11001 will check for agreement between the served IP parameters and the IP parameters stored in FLASH. If the parameters agree, it will simply apply these parameters to the current configuration.

In the event that the IP parameters do not agree, and prior to using the parameters, the Momentum 170ENT11001 will

- Overwrite the saved IP parameters with the served IP parameters to maintain consistency across parameter databases.

If, for what ever reason, the Momentum 170ENT11001 could not get the IP parameters from the FDR server, the Momentum 170ENT11001 will check the IPFallback bit and, if set, it will use the stored IP parameters. If the IPFallback bit is not set, the Momentum 170ENT11001 will continue to request its IP parameters for approximately 5 minutes.

Into SAFE I/O Mode

After the request parameters time has timed out, the Momentum 170ENT11001 will go to SAFE IO mode with its Default IP Parameters and blink the Default IP indication on the LAN_ST LED.

Access to the I/O is disabled

Obtaining Configuration (Runtime) Parameters using FDR

After receiving its IP parameters, the device attempts to obtain its configuration (runtime) parameters.

The device

1. checks if there are any outstanding updates, and
 - if outstanding updates exist, device attempts to push these changes to the FDR server. (See *About Outstanding Updates*, p. 83)
 - if no outstanding updates exist, device attempts to obtain its configuration (runtime) parameters from the FDR server using the FTP protocol.
2. after checking for updates and if the FDR server responds with the device's configuration (runtime) parameters, the device
 - checks for agreement between the served configuration parameters and the configuration parameters stored in FLASH.
 - If the configuration parameters agree, the device applies these configuration parameters to the current configuration and enables the I/Os.
 - if the configuration parameters do NOT agree, prior to using the configuration parameters, the Momentum 170ENT11001 will overwrite the saved configuration parameters with the served configuration parameters to maintain consistency across parameter databases.

In the event that, for whatever reason, the Momentum 170ENT11001 could not get access to the parameter file on the FDR server, the Momentum 170ENT11001 will check the ConfigFallback bit; and, if set, it will use the parameters stored in FLASH. If the ConfigFallback bit is not set the Momentum 170ENT11001 will go to SAFE IO mode with served IP parameters.

Finishing the Process

When the initialization phase is completed successfully, the communication adapter is ready to communicate using the Modbus TCP/IP protocol. The RUN LED will be on steady. Access to the I/O is enabled by finishing the process.

FDR Run Time

Overview

This section describes the Faulty Device Replacement (FDR) runtime behavior. FDR configuration is accessible only through the embedded Web pages.

Understanding Volatile and Nonvolatile Configurations

The Momentum 170ENT11001 supports a temporary, RAM only, version of the configuration in addition to the non-volatile FLASH/FDR version. Therefore, a temporary configuration may be different than the configuration stored in FLASH or on the FDR server.

This volatile version of the configuration would not exist after a loss of power.

Volatile configuration changes may be accomplished either by a:

- Modbus TCP/IP Write the specific configuration 4xxxxx registers
- Embedded Web Pages

On the web page the user will have the option to "apply" the displayed configuration parameters to the current configuration (i.e. create a RAM only version) OR "save" them to non-volatile storage and apply them to the current configuration.

Non-volatile configuration parameter changes are handled differently at run-time than configuration changes at start-up.

**Configuration
Database
Consistency
Check**

While running, approximately every five minutes the Momentum 170ENT11001 will read its configuration file from the FDR server and compare the configuration from the server against the configuration in FLASH, a consistency check.

In addition to ensuring consistency in the databases, this consistency check also protects against the configurations on the FDR server being lost because of a replacement of the FDR server.

While performing this consistency check, the Momentum 170ENT11001 performs the following:

- If the two configuration files are identical,

no action taken.
- If the two configuration files are different and valid,

adapter takes the configuration parameters from the FDR server and stores those parameters to FLASH and applies the current parameters.
- If the FDR server has an empty file,

device pushes its stored configuration up to the FDR server. This action safeguards against the FDR server being replaced.
- If the adapter cannot communicate with the FDR server,

adapter blinks the FDR Update Failure code on the LAN Status LED and every 30 seconds indefinitely retries to communicate successfully with the FDR server. When the problem is fixed, the Momentum 170ENT11001 clears the error and returns to a normal running state.

Note: CHANGE OF IP ADDRESS OF FDR SERVER

If the IP address of the FDR server is changed, the Momentum ENT11001 is unable to find the server and reports an FDR Update Failure code on the LAN Status LED.

Reboot the Momentum ENT11001.

**About
Outstanding
Updates**

When a Momentum 170ENT11001 is participating in FDR, all configuration changes that are stored are saved to FLASH and applied to current parameters as well as pushed to the FDR server. In the event that this push could not succeed, for example a network failure, the Momentum 170ENT11001 will have an outstanding update and will blink the FDR Update Failure code.

Upon succeeding to communicate with a FDR server, the Momentum 170ENT11001 will clear the blink code and resumes normal operation.

If a power failure occurs while an outstanding update exists, the Momentum 170ENT11001 stores the outstanding update in FLASH. When powered up the adapter will attempt to complete an outstanding update. the Momentum 170ENT11001 will push the parameters stored in the FLASH database up to the FDR server and will run with these values.

Using SNMP



At a Glance

Purpose

The following material describes using SNMP with the Momentum 170ENT11001. The material describes general concepts about SNMP and provides information specific to using SNMP with the Momentum 170ENT11001.

What's in this Chapter?

This chapter contains the following topics:

Topic	Page
Understanding SNMP	86
ASN.1 Naming Scheme	88
Configuring a Momentum 170ENT11001 with SNMP	90
Using Private MIBs for Momentum 170ENT11001 Diagnostics	92

Understanding SNMP

Overview

This following information describes Simple Network Management Protocol (SNMP).

Introduction

Network management software allows a network manager to

- Monitor and control network components
 - Isolate problems and find their causes
 - Interrogate devices such as a host computer, routers, switches, and bridges to determine their status
 - Obtain statistics about the networks to which they attach
-

Manager/Agent Paradigm

Network management software follows the conventional client-server model. To avoid confusion with other network communication protocols that use the client/server terminology, network management software uses the following terms:

- *Manager*
For the client application that runs on the manager's computer
- *Agent*
For the application that runs on a network device

The manager uses conventional transport protocols (e.g., TCP or UDP) to establish communication with the agent. Managers and agents then exchange requests and responses according to the network management protocol.

Simple Network Management Protocol

Your Momentum 170ENT11001 module maybe configured with the Simple Network Management Protocol (SNMP), which is the standard protocol used to manage a local area network (LAN). SNMP defines exactly how a *manager* communicates with an *agent*.

The SNMP defines the format of the requests that a manager sends to an agent and the format of the replies that the agent returns to the manager.

The MIB

Each object to which SNMP has access must be defined and given a unique name. Both the manager and agent programs must agree on the names and the meanings of the fetch and store operations. The set of all objects SNMP can access is known as a *Management Information Base (MIB)*.

The Private MIB

Schneider obtained a private MIB, Groupe_Schneider (3833). Under the Groupe Schneider private MIB is a Transparent Factory Ethernet private MIB. The Transparent Factory SNMP embedded component controls the Schneider Electric Transparent Factory Private MIB function.

**Choosing a
SNMP Manager**

If you have an SNMP Manager operating now, you may continue to use that SNMP Manager. If you are selecting an SNMP Manager, there are many SNMP Managers on the market, and you may use any of those managers.

**More SNMP
Information**

SNMP and related subjects are well documented on Web sites and in many books

- As of this writing, a useful description appears on Microsoft's *Technical* pages. Browse to <http://www.microsoft.com/technet>. Use the **Search** function to find "Network Management for Microsoft Networks Using SNMP."
 - Use an Internet search engine to search for an SNMP introduction, an SNMP tutorial, and other topics on SNMP.
 - The SNMP FAQ from the news group `comp.protocols.snmp` appears on many dot-com and dot-org Web pages. Search for the combination of "`comp.protocols.snmp`" and "FAQ."
 - A list of print books about SNMP appears in the SNMP FAQ. In addition, a search of most online retail-book Web sites will yield a substantial list of titles.
-

ASN.1 Naming Scheme

ASN.1 Overview Abstract Syntax Notation One (ASN.1) is a formal language for abstractly describing messages to be exchanged between distributed computer systems.

An Example Objects in a MIB are defined with the ASN.1 naming scheme that assigns each object a long prefix that guarantees that the name will be unique. For example, an integer that counts the number of IP datagrams that a device has received is named: *iso.org.dod.internet.mgmt.ip.ipinReceives*. The following figure depicts the ASN.1 Naming Scheme example.

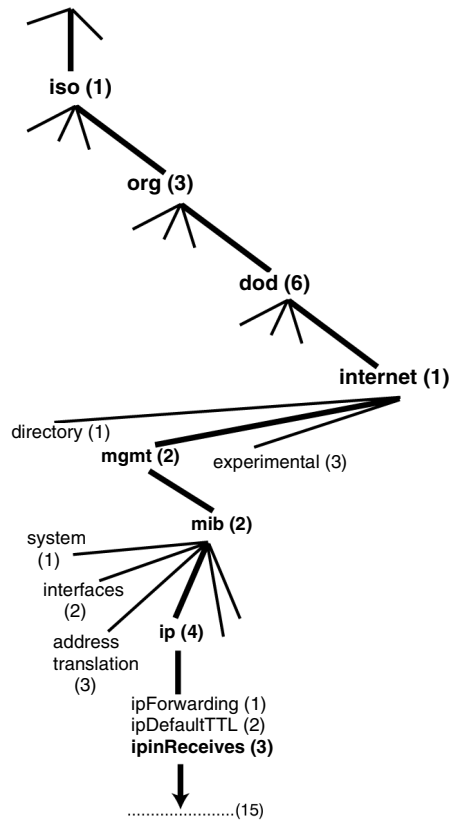

This object name is represented in an SNMP message by assigning each part an integer. So, the above message would appear as 1.3.6.1.2.2.4.3.

Each integer has the following meaning.

- 1 = ISO (International Organization for Standardization)
 - 3 = identified organization — one of branches under the ISO root
 - 6 = U. S. Department of Defense (DOD) — one of the children under branch 1.3
 - 1 = the Internet subtree under 1.3.6
 - 2 = the mgm branch — (one of seven) of the Internet subtree. It is managed by the Internet Assigned Numbers Authority, and includes the standard MIBs
 - 2 = mib-2(1) group of managed objects
 - 4 = ip — the mib-2(1) IP group (one of 11)
 - 3 = ipinReceives — the MIB object
-

Configuring a Momentum 170ENT11001 with SNMP

The Object Identifier (OID)

In the ASN.1 Naming Scheme example, the MIB object identified by the notation 1.3.6.1.2.2.4.3 is referred to as the Object Identifier or OID. All OIDs can be envisioned as part of a tree structure which begins at the root (ISO) and branches out with each subtree identified by an integer.

SNMP Protocol Data Units

SNMP uses Protocol Data Units (PDUs) to carry the requests and responses, between the manager and the agents, for the information contained in an OID. As the following figure shows, the SNMP message is the innermost part of a typical network transmission frame.

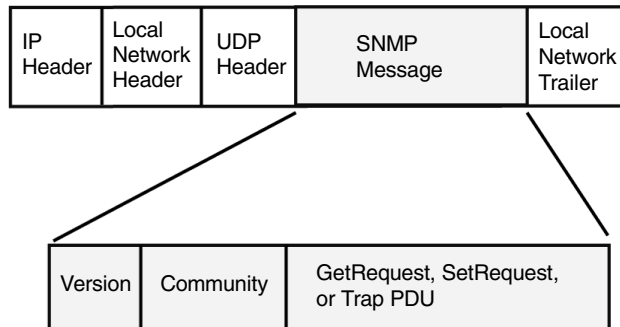

The PDUs within the SNMP initiate the communication between the manager and the agents.

The SNMP installed on your Momentum 170ENT11001 Ethernet Communication Adapter uses the following three PDUs.

- GetRequest
- SetRequest
- Trap

GetRequest PDU

The GetRequest (shortened to Get) PDU is used by the SNMP manager to retrieve the value of one or more objects (OIDs) from an agent.

SetRequest PDU

The SetRequest (shortened to Set) PDU is used by the SNMP manager to assign a value to one or more objects (OIDs) residing in an agent.

Trap PDU

The Trap PDU is used by the agent to alert the manager that a predefined event has occurred.

**Version &
Community
Identifiers**

The version identifies the version number of the SNMP software being used by the manager and the agent. Your adapter supports Version 2 of the SNMP. The community is an identifier that you assign to your SNMP network. If community names for the manager and the agent do not agree, the agent will send an authentication failure trap message to the manager. If the community names and version number agree, the SNMP PDU will be processed.

**What Can Be
Configured**

Your Momentum 170ENT11001 adapter can be configured to send an authentication trap to two SNMP managers if it receives a community name in a Get/Set request that does not match the configured name. Also, you can configure the Sys Contact and Sys Location via the configuration page in the adapter's Embedded Web pages.

Using Private MIBs for Momentum 170ENT11001 Diagnostics

Overview

This section describes the Schneider Electric Transparent Factory Private MIB and the subtrees that apply to the Momentum 170ENT11001.

Introducing Private MIB

A MIB, a Management Information Base, is an element used in network management. Network management services are based on the need to monitor and to manage:

- Performance
- Fault Occurrences
- Security

Each MIB contains a finite number of objects. Manage your MIB with a management station running an SNMP management application. The management application uses **GETs** and **SETs** to retrieve system information and to set system environment variables.

Schneider Private MIB

Schneider Electric obtained a Private Enterprise Number (PEN) from the Internet Assigned Numbers Authority (IANA). That number represents a subtree in the SNMP MIB, a number that is a unique identifier used for Groupe Schneider.

The object identifier for the root of the Groupe Schneider subtree is **1.3.6.1.4.1.3833** and represents a path to the subtree as follows:

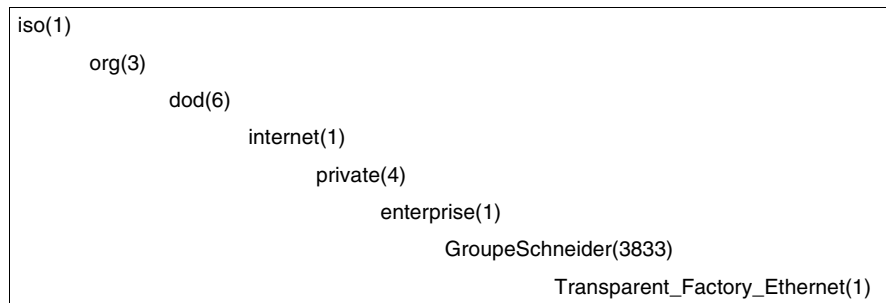

Under the GroupeSchneider private MIB is a Transparent Factory Ethernet (TFE) private MIB, **Transparent_Factory_Ethernet(1)**.

**Transparent
Factory Ethernet
Private MIB**

The Transparent Factory SNMP-embedded component controls the Schneider private MIB function. The Schneider private MIB, and associated services, perform Network Management on all components of the system. The Transparent Factory private MIB provides the data to manage the main Transparent Factory communication services for all the communication components of the Transparent Factory architecture (ETYs, NOEs, and ENTs). The Transparent Factory private MIB does not define the specific management applications and policies. The diagram below illustrates the Schneider Electric (Groupe_Schneider (3833) private enterprise MIB subtree.

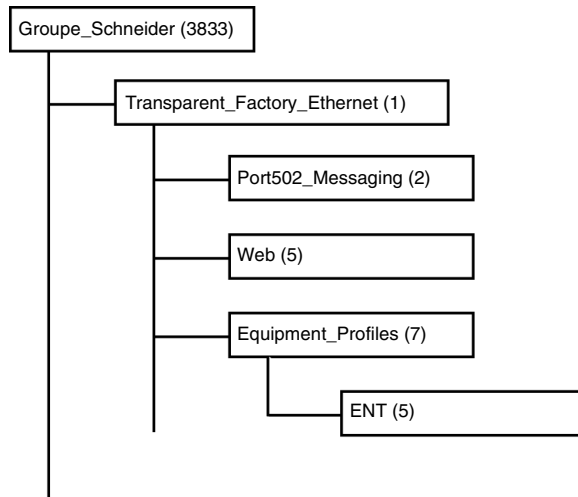

The **Groupe_Schneider (3833)** subtree is the root of Groupe Schneider's private MIB in the Structure of Management Information (SMI) used by SNMP and defined in RFC-1155, which is a specification that defines the structure and identification of management information for TCP/IP-based Internets.

Transparent Factory Ethernet Subtree

The **Transparent_Factory_Ethernet (1)** subtree defines groups that support the Transparent Factory Ethernet services and devices.

Service	Description
Port502_Messaging (2)	Subtree defines objects for managing explicit client / server communications supporting applications, such as HMI, SCADA, or programming tools
Web (5)	Subtree defines objects for managing the activity of the embedded Web servers
Equipment_Profiles (7)	Subtree identifies objects for each type of device in Transparent Factory Ethernet's product portfolio

Device subtrees, or groups, will be defined for the **ENT(5)**.

As devices are added to Schneider's catalog, Schneider's private MIB will be extended in the following manner:

- If needed, a Transparent Factory, communication-service object will be added for the new device in the corresponding **Equipment_Profiles(7)** subtree. As many objects as needed can be added to this subtree.
- If needed, a new branch will be added at the same level as **Transparent_Factory_Ethernet(1)**. This subtree will be created for product-specific objects.

When a new device is created, a corresponding object description is created in the ASN.1 format. The ASN.1 file(s) are then given to producers of SNMP manager software for inclusion in their products.

Port502 Messaging Subtree

The Port502_Messaging (2) subtree, or group, provides connection management and data flow services. The following list describes the function of each object.

Service	Description
port502Status(1)	Indicates the status of the service (Idle, Operational)
port502SupportedProtocol(2)	Indicates the supported protocols (Modbus, Xway)
port502IpSecurity(3):	Indicates the status of the port 502 IP Security service (enabled/disabled)
port502MaxConn(4)	Indicates the maximum TCP connection number supported by the port 502 entity
port502LocalConn(5)	Indicates the TCP connection number currently opened by the local port 502 entity
port502RemConn(6)	Indicates the TCP connection number currently opened by the remote entity to the local port 502 entity
port502IpSecurityTable(7)	Indicates a table containing the number of unsuccessful TCP connection open tries from a remote TCP entity
port502ConnTable(8)	Indicates a table containing port 502 TCP specific information (MsgIn, MsgOut)
port502MsgIn(9)	Indicates the total number of port 502 messages received from the network
port502MsgOut(10)	Indicates the total number of port 502 messages sent from the network
port502MsgOutErr(11)	Indicates the total number of error messages built by the port 502 messaging entity and sent to the network
port502AddStackStat(12)	Indicates the support of additional port 502 stack statistics 1 - Disabled 2 - Enabled
port502AddStackStatTable(13)	Indicates additional stack statistics for port 502 (optional)

Web Subtree

The Web (5) subtree, or group, contains the objects related to the Web server service.

Service	Description
webStatus(1)	Indicates the global status of the Web service 1 - Idle 2 - Operational
webPassword (2)	Indicates a switch to enable or disable the use of Web passwords 1 - Disabled 2 - Enabled
webSuccessfulAccess (3)	Indicates the total number of successful accesses to the Web site
webFailedAttempts (4)	Indicates the total number of unsuccessful accesses to the Web site

Equipment Profile Subtree

The Equipment_Profiles (7) subtree contains a set of common objects.

Service	Description
profileProductName(1)	Displays the commercial name of the communication product in a string form (for example: Momentum 170ENT11001)
profileVersion(2)	Displays the software version of the communication product in a string form (for example: Vx.y or V1.1)
profileCommunicationServices(3)	Displays a list of the communication services supported by the profile (Port502Messaging, Web)
profileGlobalStatus(4)	Indicates the global status of the communication module 1 - nok 2 - ok
profileConfigMode(5)	Indicates the IP configuration mode of the communication module 1 - Local: The IP configuration is created locally 2 - dhcpServed: The IP configuration is created by a remote DHCP server
profileRoleName(6)	Indicates the role name for the IP address management if it exists (Empty string if there is none)
profileBandwidthMgt(7)	Indicates the status of Bandwidth Management 1 - Disabled 2 - Enabled
profileBandwidthDistTable(8)	N/A for the Momentum 170ENT11001

Service	Description
profileLedDisplayTable(9)	Displays a table giving the name and the state of each module's LEDs
profileSlot(10)	N/A for the Momentum 170ENT11001
profileCPUType(11)	N/A for the Momentum 170ENT11001
profileTrapTableEntriesMax(12)	Indicates the maximum numbers of entries in the Trap Table. This entry equals the number of possible remote managers
profileTrapTable(13)	Displays a table allowing you to enable or disable the private traps for each of the communication services
profileSpecificId(14)	Indicates a unique Profile Specific Identification inside the equipmentProfile object of the Schneider Transparent Factory MIB. (For example the PLC Premium family is 100)
profileIpAddress(15)	Indicates the IP address of the SNMP agent
profileIpNetMask(16)	Indicates the subnet mask associated with the IP address of the SNMP agent. The value of the mask is an IP address with all the network bits set to 1 and all the host bits set to 0
profileIpGateway(17)	Indicates the default Gateway IP address of the SNMP agent
profileMacAddress(18)	Indicates the Ethernet media-dependent address of the SNMP agent

Private Traps and MIB Files

Traps are used to signal Status Changes to the manager. Using traps helps to avoid adding traffic.

The four status changes signaled by the trap are for the:

- LEDs
- Communication Ports
- Error Conditions

The following list describes the characteristics of private traps, which means that they can:

- Send messages to the two managers whose IP addresses are configured in the SNMP configuration
- Use the community name given to this configuration
- Enable or disable each of the Transparent Factory MIB groups: Switch (1), Port502_Messaging (2), Web (5), and Equipment_Profiles (7)

Private traps are described in the MIB ASN.1 description, which is contained in a **.mib** text file.

Using the Network Options Ethernet Tester



8

At a Glance

Introduction

This chapter describes how to use the *Network Options Ethernet Tester* with a Windows based PC. This program can monitor the network by supplying you with operational statistics and provides the capability of reading and writing PLC registers.

What's in this Chapter?

This chapter contains the following topics:

Topic	Page
Installing the Network Options Ethernet Tester	100
Establishing a Connection with an Ethernet Module	101
Getting and Clearing Statistics	103
Understanding Statistics	106
Reading Registers	108
Writing Registers	109
Using the Test Button	111

Installing the Network Options Ethernet Tester

Overview

The following information describes how to install the Network Options Ethernet Tester.

Introduction

The Network Options Ethernet Tester utility allows you to get and clear statistics and to read and write registers over the network, using a Windows-based PC.

Installation Procedure

The Network Options Ethernet Tester is supplied to you on a utility diskette. The following steps describe how to install the tester on your PC.

Step	Action
1	Insert the Network Options Ethernet Tester utility disk into drive A:
2	Select Run from the Start menu.
3	Type A:\SETUP and click on the OK button—the Welcome dialog will appear.
4	Click on the Next button and follow the instructions that appear in each of the dialogs to complete the installation.* *Each installation dialog has Back and Next buttons that allow you to move back to the previous dialog or to move forward to the next dialog.

Establishing a Connection with an Ethernet Module

Overview

The following information describes how to use the Network Options Ethernet Tester when connecting to an Ethernet adapter.

What You Must Know

To establish a connection with an Ethernet module using the Network Options Ethernet Tester you must know the module's IP network address or role name.

Procedure for Connecting with an Ethernet Module

Perform the following steps to establish a connection with an Ethernet module using the Network Options Ethernet Tester.

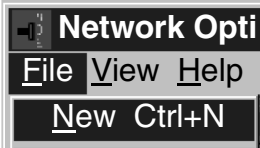
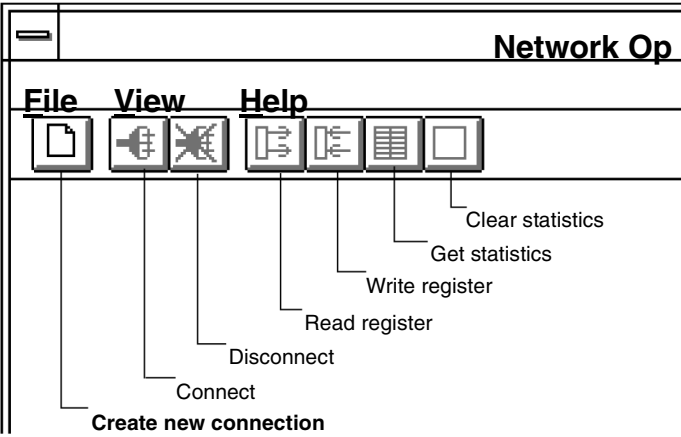
Step	Action
1	<p>As shown in the following figure, from the initial menu select File New,</p>  <p>or click the Create new connection icon.</p>  <p>The result of File New or click Create new connection is that the Remote IP Address dialog box displays.</p>

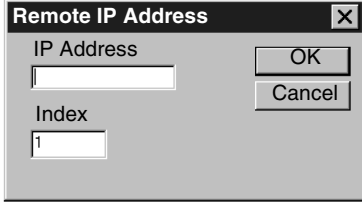
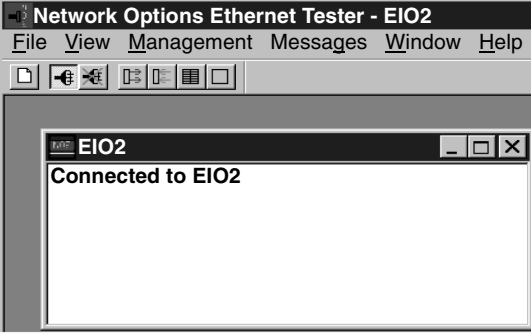
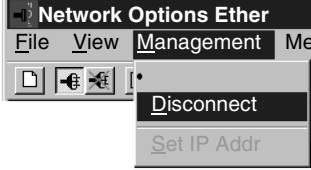
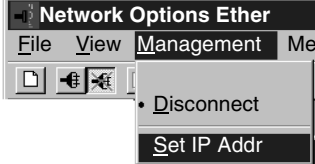
Step	Action
2	<p>Type the adapter's IP network address or role name in the IP Address field.</p>  <p>Click OK. As shown in the following figure, this dedicates a connection from your PC to the designated Ethernet module and brings you to the main menu.</p> 
3	<p>You may establish several connections with the same module or with other modules by repeating step 2 for each new connection.</p>
4	<p>When you are ready to disconnect, select Management Disconnect from the pull-down menu, or click the Disconnect button in the toolbar.</p> 
5	<p>After disconnecting from one module, you may reassign its dedicated connection by selecting Management Set IP Addr from the pull-down menu. Type the new IP network address or role name in the box provided.</p> 

Getting and Clearing Statistics



Overview



The following information describes how to use the Network Options Ethernet Tester to obtain and to clear statistics.

Procedures for Getting and Clearing Statistics

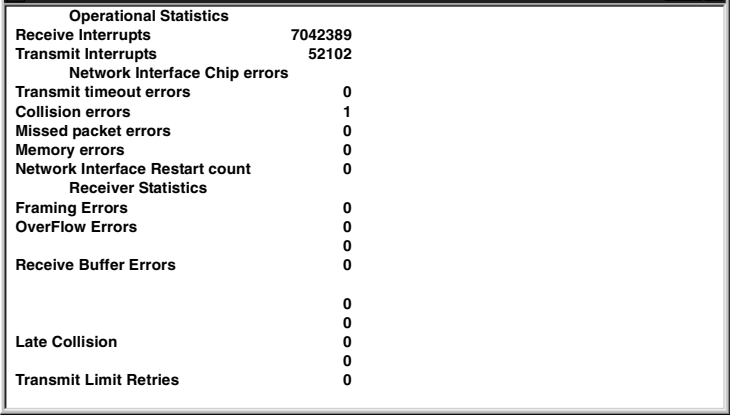
Perform the following steps to get statistics from the Ethernet module using your Network Options Ethernet Tester.

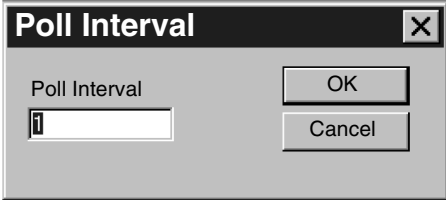
Step	Action
1	Establish a connection with the Ethernet module.
2	As shown in the following figure, select Messages from the main menu and choose Get Stats from the pull-down menu. Alternatively, you can click on the Get Statistics button in the toolbar. The Get Statistics dialog box, which is shown in step 3, displays. <div data-bbox="485 634 769 800" data-label="Image"> <p>A screenshot of a software window titled 'Messages Window'. The window has a menu bar with 'Messages' and 'Window'. Below the menu bar, there are two menu items: 'Read Register...' and 'Get Stats...'. The 'Get Stats...' item is highlighted with a dark background.</p> </div>
3	As shown in the following figure, you can type a polling interval (the number of seconds between transactions) in the box provided and click on the OK button. <div data-bbox="481 883 865 1036" data-label="Image"> <p>A screenshot of a dialog box titled 'Get Statistics'. The dialog box has a title bar with a close button (X). Inside the dialog, there is a label 'Polling Interval' followed by a text input field containing the number '1'. To the right of the input field are two buttons: 'OK' and 'Cancel'.</p> </div>

Step	Action																																				
4	<p>As shown in the following figure, complete statistics for the module will be printed in the window for this connection.</p>  <table border="1" data-bbox="502 272 1232 683"> <thead> <tr> <th colspan="2">Operational Statistics</th> </tr> </thead> <tbody> <tr> <td>Receive Interrupts</td> <td>7042389</td> </tr> <tr> <td>Transmit Interrupts</td> <td>52102</td> </tr> <tr> <td colspan="2">Network Interface Chip errors</td> </tr> <tr> <td>Transmit timeout errors</td> <td>0</td> </tr> <tr> <td>Collision errors</td> <td>1</td> </tr> <tr> <td>Missed packet errors</td> <td>0</td> </tr> <tr> <td>Memory errors</td> <td>0</td> </tr> <tr> <td>Network Interface Restart count</td> <td>0</td> </tr> <tr> <td colspan="2">Receiver Statistics</td> </tr> <tr> <td>Framing Errors</td> <td>0</td> </tr> <tr> <td>OverFlow Errors</td> <td>0</td> </tr> <tr> <td>Receive Buffer Errors</td> <td>0</td> </tr> <tr> <td></td> <td>0</td> </tr> <tr> <td></td> <td>0</td> </tr> <tr> <td>Late Collision</td> <td>0</td> </tr> <tr> <td></td> <td>0</td> </tr> <tr> <td>Transmit Limit Retries</td> <td>0</td> </tr> </tbody> </table>	Operational Statistics		Receive Interrupts	7042389	Transmit Interrupts	52102	Network Interface Chip errors		Transmit timeout errors	0	Collision errors	1	Missed packet errors	0	Memory errors	0	Network Interface Restart count	0	Receiver Statistics		Framing Errors	0	OverFlow Errors	0	Receive Buffer Errors	0		0		0	Late Collision	0		0	Transmit Limit Retries	0
Operational Statistics																																					
Receive Interrupts	7042389																																				
Transmit Interrupts	52102																																				
Network Interface Chip errors																																					
Transmit timeout errors	0																																				
Collision errors	1																																				
Missed packet errors	0																																				
Memory errors	0																																				
Network Interface Restart count	0																																				
Receiver Statistics																																					
Framing Errors	0																																				
OverFlow Errors	0																																				
Receive Buffer Errors	0																																				
	0																																				
	0																																				
Late Collision	0																																				
	0																																				
Transmit Limit Retries	0																																				
5	<p>As shown in the following figure, to change the polling interval without interrupting communication with the Ethernet module, select Messages and choose Poll Interval.</p>  <p>The screenshot shows a menu titled "Messages Window" with the following options: Read Register..., Write Register..., Get Stats..., Clear Stats..., and Poll Interval... (highlighted).</p>																																				
6	<p>As shown in the following figure, type the new polling interval in the box provided, and click on the OK button.</p>  <p>The screenshot shows a dialog box titled "Poll Interval" with a close button (X) in the top right corner. It contains a text input field labeled "Poll Interval" with the number "1" entered, and two buttons: "OK" and "Cancel".</p>																																				

Step	Action
7	<p>As shown in the following figure, to clear statistics select Messages and choose Clear Stats from the pull-down menu. Alternatively, click on the Clear Statistics button in the toolbar.</p>  <p>The screenshot shows a window titled 'Messages Window'. The menu items are: 'Read Register...', 'Write Register...', 'Get Stats...', and 'Clear Stats...'. The 'Clear Stats...' option is highlighted with a dark background.</p>
8	<p>The following figure shows the Clear Statistics dialog box. Click on the OK button.</p>  <p>The screenshot shows a dialog box titled 'Clear Statistics'. It has a 'Polling Interval' field with the value '1' and two buttons: 'OK' and 'Cancel'.</p> <p>Result: As shown in the following figure, the Clear Statistics Request for the connection displays.</p>  <p>The screenshot shows a window titled 'EIO2'. It displays 'Clear Statistics Request' and 'Total Transaction Count' with the value '675'.</p>

Understanding Statistics

Overview

The following information describes the type of statistics provided by the Network Options Ethernet Tester.

Statistics Description

Submit a Get Statistics Request and the Network Options Ethernet Tester provides status information about the module. Other statistics provided by the Network Options Ethernet Tester appear in a list following the results of the Get Statistics Request.

The following parameter information displays when a Get Statistics Request is submitted.

Parameter	Information	
Model:	Model number	
Media:	10Base-T	HALF DUPLEX FULL DUPLEX
	100Base-T	HALF DUPLEX FULL DUPLEX
Adapter:	Running Stopped I/O stopped. Adapter is in safe mode.	
Crash Log Empty	Yes No - A crash log entry appears.	

The Network Options Ethernet Tester can provide the following statistics:

Statistic	Description
Total Transaction Count	Displays number of transaction completed.
IP Address	Displays IP Address.
MAC Address	Displays MAC Address
Receive Interrupts and Transmit Interrupts	Displays number of times the PCNET controller chip has generated interrupts.
Transmit timeout errors	Displays number of times the transmitter has been on the channel longer than the interval required to send the maximum length frame of 1519 bytes. The Transmit timeout error is also known as a babble error.
Collision errors	Displays number of collisions detected by the Ethernet chip.
Missed packet errors	Displays number of times a received frame was dropped because a receive descriptor was not available.

Statistic	Description
Memory errors	Displays number of times an Ethernet controller chip experienced an error accessing shared RAM. A memory error will cause a restart.
Network Interface Restart count	Displays number of times the Ethernet controller chip was restarted due to fatal runtime errors, including memory errors, transmit buffer errors, and transmit underflow.
Framing errors	Displays number of times an incoming frame contained a non-integer multiple of eight bits.
Overflow errors	Displays number of times the receiver has lost part or all of an incoming frame, due to an inability to store the frame in memory before the internal FIFO overflowed.
CRC errors	Displays number of times a CRC (FCS) error was detected on an incoming frame.
Receive buffer errors	Displays number of times a receive buffer was not available while data chaining a received frame.
Transmit buffer errors	Displays number of times the end packet flag on the current buffer was not set and the Ethernet controller did not own the next buffer. A transmit buffer error causes a restart.
Silo Underflow	Displays number of times a packet was truncated due to data late from memory. A Silo Underflow will cause a restart.
Late Collision	Displays number of times a collision was detected after the slot time of the channel had elapsed.
Lost Carrier	Displays number of times a carrier was lost during a transmission.
Transmit Limit Retries	Displays number of times the transmitter has failed after 16 attempts to transmit a message, due to repeated collisions.

These statistics also may be obtained from the MSTR block. Refer to the *Ladder Logic Block Library User Guide*, 840USE10100 for details.

Reading Registers

Overview

The following information describes how to read Ethernet adapter registers with the Network Options Ethernet Tester.

Reading Registers Procedure

The following procedure describes how to read registers from the Ethernet adapter using your Network Options Ethernet Tester.

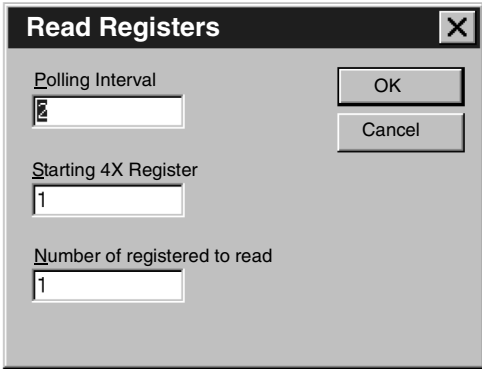
Step	Action
1	Establish a connection with the Ethernet adapter.
2	Select Messages from the main menu.
3	As shown in the following figure, choose Read Register from the Messages menu, or click the Read Register button in the toolbar. The Read Register dialog box displays. 
4	Type the number of seconds between transactions in the Polling interval field. 
5	In the Starting 4x Register field, type the register number of the first 4x register. When typing the 4x register number, omit the leading 40 or 400, as shown in the figure in Step 4.
6	Type in the number of registers to read in the Number of registers to read field.
7	Click OK . The register values display in the window for this connection. Five values will be listed in each row, with the number of the first register at the beginning of the row.

Writing Registers

Overview

The following information describes how to write registers from the Ethernet module to the Network Options Ethernet Tester.

Writing Registers Procedure

The following procedure describes how to write registers from the Ethernet module using your Network Options Ethernet Tester.

Step	Action
1	Establish a connection with the Ethernet module.
2	Select Messages from the main menu.
3	As shown in the following figure, select Write Register from the Messages menu, or click the Write Register button in the toolbar. The Write Register dialog box displays. <div data-bbox="436 592 724 722" style="border: 1px solid black; padding: 5px; margin: 10px 0;"> <p>Messages <u>W</u>indows</p> <p>Read Register...</p> <p>Write Register...</p> </div>
4	Type the number of seconds between transactions in the Polling Interval field. <div data-bbox="436 776 926 1156" style="border: 1px solid black; padding: 10px; margin: 10px 0;"> <p>Write Register [X]</p> <p>Polling Interval <input type="text" value="2"/> <input type="button" value="OK"/></p> <p>First 4X register to write <input type="text" value="1"/> <input type="button" value="Cancel"/></p> <p>Number of registers to write <input type="text" value="1"/> <input type="checkbox"/> Increment Write Data</p> <p>Write Data <input type="text" value="1"/></p> </div>
5	Type in the number of the first 4x register you want to write in the First 4x Register to Write box. When typing the 4x register number, omit the leading 40 or 400, as shown in the figure in step 4.
6	Type in the number of registers to write in the Number of registers to write box.
7	Type in the data to be written to those registers in the Write Data box.
8	Select the Increment Write Data check box if you want the data you have entered to be increased by one with each transaction.
9	Click OK . The register values will be displayed in the window for this connection.

**Read or Write
Request Error**

If you try to read or write registers and an error occurs, the Network Options Ethernet Tester will display a Read Request Error or Write Request Error. The error codes correspond to MSTR block error codes. For more information, refer to the *Ladder Logic Block Library User Guide*, 840USE10100.

Using the Test Button

Overview

This section describes the Test Button option available in the Network Options Ethernet Tester.

General Description - Test Button

The Network Options Ethernet Tester is an option that allows you to test data. There are three methods of testing:

- Use the same data written to all registers
- Use increasing data written uniquely to each register
- Use random data written uniquely to each register

The test writes the data then reads the data. A pass/fail counter is used to display the number of times the data written is read correctly.

Test Function and Options

You may access the test option through the **Test Data** menu option. On the **Messages** menu click **Test Data...**

The second option is to use the test button, which appears on the menu bar. Click the test button.



Both options open the **Test Data** dialog box.

The screenshot shows a dialog box titled "Test Data" with a close button in the top right corner. The dialog contains the following elements:

- Polling Interval:** A text input field containing the number "1".
- Starting 4X Register:** A text input field containing the number "1".
- Number of registers to read:** A text input field containing the number "1".
- Increment Write Data:** A checkbox that is currently unchecked.
- Data Selection:** Three radio buttons are arranged vertically:
 - Using Same Data:** This radio button is selected.
 - Using Increasing Data:** This radio button is unselected.
 - Using Random Data:** This radio button is unselected.
- Buttons:** "OK" and "Cancel" buttons are located on the right side of the dialog.

The Test Data dialog box requests that you enter three variables:

- Polling Interval
- Starting 4X Register
- Number of registers to read

The **Test Data** dialog box offers you the option to increment Write Data with every transaction. Check the **Increment Write Data** box.

Once selected, you need to choose one of three options for incrementing Write Data. Choose by selecting the appropriate radio button.

- **Using Same Data**

Each register receives the same data.

For example: Register 1 receives the value 1. Register 2 receives the value 1.

- **Using Increasing Data**

Each register receives unique data

For example: Register 1 receives the value 1. Register 2 receives the value 2.

- **Using Random Data**

Each register receives a data value assigned randomly.

For example: Register 1 receives the value 625. Register 2 receives the value 264.

Momentum Model 170ENT11000/ 170ENT11002 Ethernet Communication Adapter

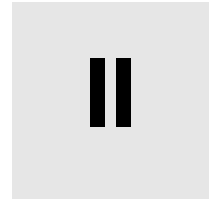

At a Glance

Purpose

The material in this part of the user guide describes the Momentum model 170ENT11000 Ethernet Communication adapter and its replacement the Momentum 170ENT11002. This adapter is configured through the Modbus TCP/IP protocol.

The content about the Momentum 170ENT11000 presented in this part was available in a 1998 user guide. The previous guide was obsoleted and appears here in these two sections:

- *Momentum Ethernet Communication Adapter 170ENT11000*
- *Communicating with the Adapter*

The Momentum 170ENT11002 is a direct replacement for the existing 170ENT11000. The Momentum 170ENT11002 is configured and functions identically to the Momentum 170ENT11000. The replacement, Momentum 170ENT11002, includes an enhanced grounding system and a relocated communication connector.

What's in this Part?

This part contains the following chapters:

Chapter	Chapter Name	Page
9	Momentum Ethernet Communication Adapter 170ENT11000/ 170ENT11002	115
10	Communicating with the Adapter	129

Momentum Ethernet Communication Adapter 170ENT11000/170ENT11002

9

At a Glance

Purpose

The following material describes the Momentum model 170ENT11000 Ethernet Communication Adapter and the Momentum model 170ENT11002. Configure the Momentum 170ENT11000/170ENT11002 using Modbus TCP/IP.

What's in this Chapter?

This chapter contains the following topics:

Topic	Page
Product Overview	116
Example: Data Turnaround Time	119
Status Indicators	121
Connecting to the Network	123
Placing the Adapter into Service	124
Replacing an Adapter	126

Product Overview

Overview

This material describes the Momentum170ENT11002, an adapter that can be connected to any Momentum I/O base to create a functional I/O module. The Momentum 170ENT11002 is a direct replacement for the Momentum 170ENT11000.

Function

This adapter is installed on any Momentum I/O base to form a complete I/O module that communicates on an Ethernet network. The module provides direct connection to the Ethernet network, enabling an Ethernet host to communicate with field devices wired to the I/O base terminals. A programmable controller or other host device on the network can then read from the input terminals and write to the output terminals of the I/O base.

The adapter communicates with host devices using Modbus Application Protocol with TCP/IP packets. It supports both Ethernet II and IEEE802.3SNAP framing. For information about using Modbus Application Protocol with TCP/IP, refer to the *Ethernet TCP/IP Module User Guide*, product number 840USE107. Details of the Modbus protocol are provided in the *Modbus Protocol Reference Guide*, part number PI--MBUS--300.

For information about the application and field wiring of I/O bases, refer to the *Momentum I/O Bases User Manual*, product number 870USE002.

Momentum 170ENT11000 Communication Adapter with Momentum I/O Base

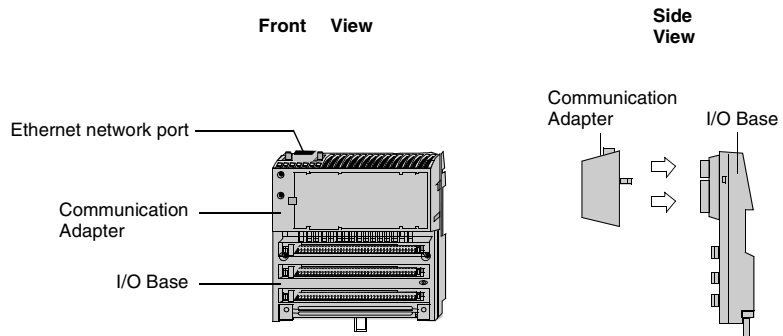

Momentum 170ENT11002 Communication Adapter with Momentum I/O Base with Ground Screw

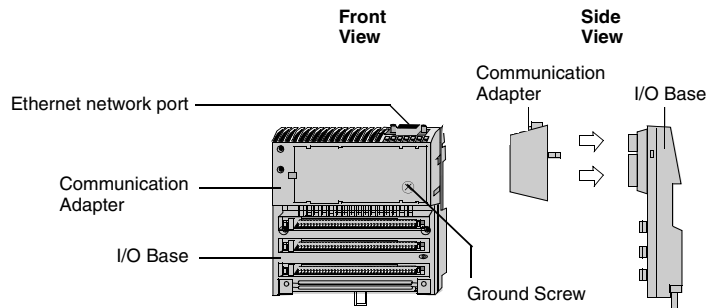

Physical Structure

Each adapter connects to the internal communication connector of its I/O base. Clips lock the adapter in place and can be released with a common screwdriver to remove the adapter. Ground screw can be used to provide an enhanced grounding system. The user can fill out the front panel wiring label (supplied with the I/O base) to identify the wiring connections at the I/O base terminals.

The adapter is considered open equipment and must be mounted in an enclosure that is approved for the site at which it is installed.

Operating Voltages and Error Control

Power for the adapter and I/O base is provided by the user at the field location. The adapter receives its operating voltage through its I/O base internal connection. The adapter monitors its voltage and goes off line to the network if the voltage is not within tolerance.

Mapping Data to I/O Base Field Terminals

Data is mapped between the application and I/O base field terminals in the IEC format. Refer to the *Momentum I/O Bases User Manual*, 870USE002 for the mapping diagrams for the I/O bases.

Managing Throughput to I/O Bases

To ensure deterministic timing of I/O messages, you should design your network to include only your application host and your I/O base communication adapters. Adding other kinds of devices, such as user interfaces or programmers, can cause variables in I/O message timing when those devices access the network.

Specifications

Network Specifications

Description	Specification
Ethernet interface	Compliant with the STP or UTP 100 ohm connection

Agency Approval

Agency	Status
UL 508	Approved
CAN/CSA C22.2NO.142	Approved
CE Mark	Approved

Example: Data Turnaround Time

Overview

This material describes the Momentum 170ENT11002, an adapter that can be connected to any Momentum I/O base to create a functional I/O module.

Description

The figure below shows an example of a control loop constructed to measure the data turnaround time at the field terminals of a pair of I/O bases.

A host PC running the test program is connected by Ethernet to two adapters with discrete I/O bases. The field output terminals of the output base are wired directly to the field input terminals of the input base. An oscilloscope is used to time the switching of the field signals.

Example: Data Turnaround Time

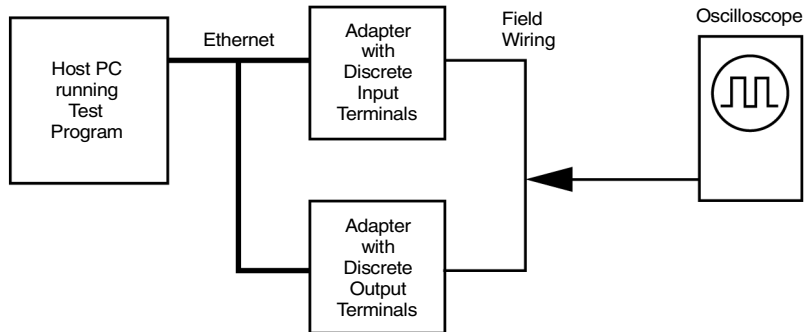

The test program is a Java loop that performs this sequence:

- Continuously reads the input terminals of the input base module.
 - Writes an output terminal to a new (ON or OFF) condition.
 - When a changed state is received from the inputs, toggles the outputs.
-

Measurement Tests

The oscilloscope measures the time duration of the ON state of the outputs.
Data Turnaround Time Measurement

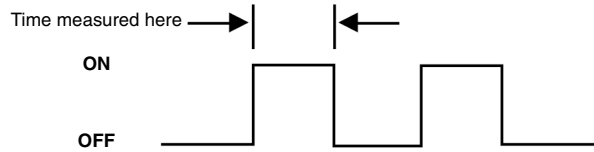

Tests were conducted on two separate NT work stations with these configurations:

- 200 MHz, 96 MB RAM
- 100 MHz, 32 MB RAM

The table below shows the measured data turnaround times. The results indicate that the major factor affecting data timing is the speed of the loop execution in the host.

Results: Data Turnaround Time

Networked Devices	Network Loading	Minimum Time	Maximum Time	Average Time	Host CPU Speed and RAM
2	10%	5 ms	9 ms	6.2 ms	200MHz 96 MB
2	40%	5 ms	9 ms	6.2 ms	200MHz 96 MB
2	70%	6 ms	9 ms	6.3 ms	200MHz 96 MB
64	10%	6 ms	8 ms	6.8 ms	200MHz 96 MB
64	40%	6 ms	12 ms	8.4 ms	200MHz 96 MB
64	70%	6 ms	13 ms	8.2 ms	200MHz 96 MB
64	10%	25 ms	30 ms	26.7 ms	100MHz 32 MB
64	40%	25 ms	30 ms	26.7 ms	100MHz 32 MB
64	70%	26 ms	30 ms	27.0 ms	100MHz 32 MB

Status Indicators

Overview

This material describes the Momentum 170ENT11000, an adapter that can be connected to any Momentum I/O base to create a functional I/O module.

Description

The adapter has two front panel indicators showing its operation status.

Momentum 170ENT11000 Indicators

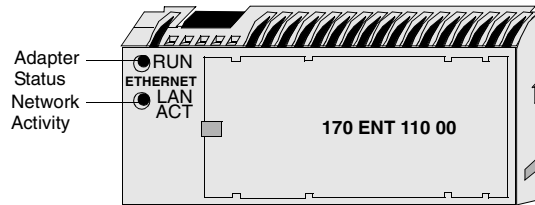

Momentum 170ENT11002 Indicators

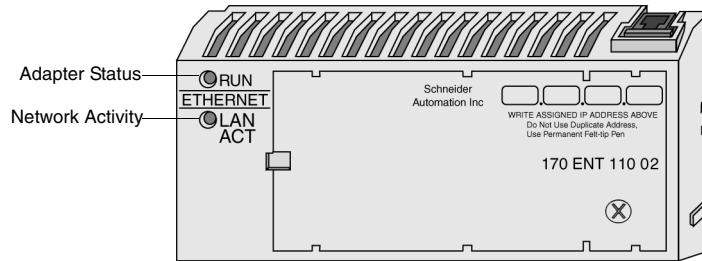

Run Indicator: Adapter Status

Indicator State	Status
On (steady)	Normal operation: power is present from I/O base, and the adapter is ready for network communication.
3 Flashes, long Off	No Link: The network cable is not connected or is defective.
4 Flashes, long Off	No MAC Address: The adapter's MAC address is not set. Internal hardware problem.
5 Flashes, long Off	No IP Address: The adapter is attempting to obtain an IP Address from a BOOTP server.
6 Flashes, long Off	The adapter's internal executive program has started, but cannot initialize the I/O base.
7 Flashes, long Off	The adapter has obtained an IP address, but does not have a valid executive program.
8 Flashes, long Off	The adapter's executive program has failed during execution.
Flashing constantly	Adapter is downloading its executive program.

LAN ACT Indicator: Network Activity

Indicator State	Status
Flashing	Normal operation: Adapter detects network activity. Flashing rate indicates the amount of activity. May appear steadily On if network activity is high.
Off	Adapter is not detecting any network activity.

Connecting to the Network

Overview

This material describes the Momentum 170ENT11002, an adapter that can be connected to any Momentum I/O base to create a functional I/O module.

Network Connector

The adapter has one RJ-45 connector for a 10Base-T UTP/STP (Unshielded or Shielded Twisted Pair) cable. The adapter should be cabled directly to the Ethernet hub.

Network Connector for Momentum 170ENT11002

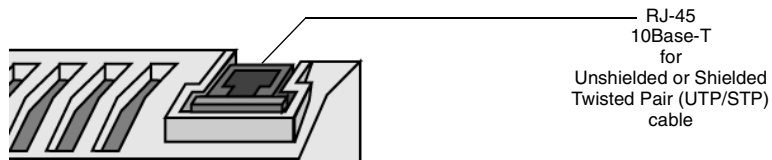

Network Connector for Momentum 170ENT11000

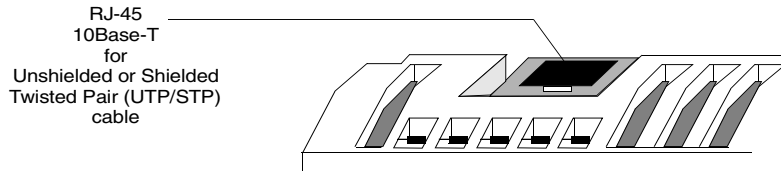

Network Labels: Global Address and IP Address

The adapter has two labels mounted on its end panels. One label identifies the adapter's IEEE Global Address (MAC address). The other identifies its Internet Protocol address (IP address).

The installer records the Global Address and gives it to the network administrator for use in establishing an IP address for the adapter during the BOOTP process at startup. When the IP address has been assigned, the administrator gives this address to the installer who writes it onto the adapter's IP address label.

Adapter Labels: Global Address and IP Address

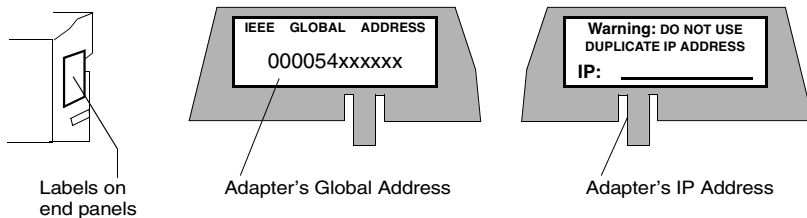

Placing the Adapter into Service

Overview

This material describes the Momentum 170ENT11002 (170ENT11000), an adapter that can be connected to any Momentum I/O base to create a functional I/O module.

Initialization and Self-Tests

When the adapter receives its initial operating power from its I/O base, it performs internal initialization and self-tests. If the tests fail, the RUN indicator flashes to indicate the failure reason, if possible, and the adapter remains offline. If the tests are successful, the adapter attempts to obtain its Ethernet IP address.

Assigning an Ethernet IP Address

Overview: Address Assignment

A BOOTP server is required to assign a new IP address to the adapter. After the server assigns the IP address, the server application can issue a command to the adapter to cause it to store the address internally.

If the adapter has stored its address and is re-initialized (for example, following a power loss), the adapter will reissue requests for an address from a BOOTP server. If a server responds with an address, the adapter will use that address. If a server does not respond, the adapter will revert to its stored address.

Requesting the IP Address

After completing its initialization, the adapter requests its Ethernet IP address from a BOOTP server. The adapter uses its MAC address with the BOOTP protocol over the Ethernet network.

Receiving the Server Response

The adapter will wait ten seconds for a BOOTP server to respond with the adapter's IP address. If the server response is received, the adapter will use that address as long as power remains applied to the adapter.

	<p>CAUTION</p>
	<p>UNINTENDED OPERATION — DUPLICATE IP ADDRESS</p> <p>Having two or more devices with the same IP address can cause unpredictable operation of your network.</p> <ul style="list-style-type: none"> • Ensure that this device will receive a unique IP address. • Before removing a 170ENT11002 (170ENT11000) adapter from service, you should first write a logical 0 (zero) into the parameter storage register 4F411 to clear the adapter's stored parameters. This will reduce the possibility of a duplicate address appearing on your network if the adapter is later restored to service. • Refer to the section Communication Access Registers for a description of the 170ENT11002 (170ENT11000) adapter's registers, including how to clear the adapter's stored parameters. <p>Failure to follow this precaution can result in injury or equipment damage.</p>

Retries to the Server

If a BOOTP server response is not received, the adapter will retry the request six times: three times using the Ethernet II framing type, and three times using the 802.3SNAP framing type.

Server Response Not Received (IP Address Previously Stored)

If the adapter receives no response to any of its attempts to obtain an IP address, and if an address has been previously stored by a Modbus Write command from the application, the adapter will then use that stored address.

Server Response Not Received (IP Address Not Stored)

If the adapter receives no response to any of its attempts to obtain an IP address, and if it does not have any stored address, the adapter will continue to retry the BOOTP request every 30 seconds. During this time it will flash its RUN indicator in the 'requesting' pattern (a sequence of five flashes).

Identifying the I/O Base

After the adapter receives its IP address, it runs an internal procedure to identify its I/O base. If the procedure fails, the adapter's RUN indicator flashes a failure pattern (six flashes) and will remain offline.

If the I/O base is successfully identified, the adapter is ready to communicate using the Modbus protocol over TCP/IP.

Storing the IP Address in the Adapter

The adapter has a non-volatile RAM area for storing its assigned IP address. If the application requires the adapter to retain its current IP address, the application must issue a Modbus Write command to write a boolean value into a specific register in the adapter to cause the address to be stored. The adapter's default state is to not store the address.

The section, *Communication Access Registers*, describes how to store the IP address and how to determine if an address has been previously stored.

Replacing an Adapter

Overview

This material describes the Momentum 170ENT11002 (170ENT11000), an adapter that can be connected to any Momentum I/O base to create a functional I/O module.

Erase the Stored IP Address

Before removing any adapter from service, you should clear its IP address. The adapter has a non-volatile RAM area for storing its assigned IP parameters. The parameters are retained when power is removed from the adapter, and will remain permanently in the adapter when it is removed from service. If the adapter is subsequently returned to service it would be possible for it to cause unspecified activity on your network. You should therefore erase the current parameters before removing the adapter from service.

The adapter has an internal register which defines the boolean state (saved or not saved) of its IP parameters. The register can be read by the application, and it can be written into causing the adapter to clear the parameters.

	CAUTION
	DUPLICATE ADDRESS HAZARD <p>Having two or more devices with the same IP address can cause unpredictable operation of your network.</p> <ul style="list-style-type: none">• Before removing any adapter from service, you should first write a logical 0 (zero) into the parameter storage register to clear the adapter's stored parameters. This will reduce the possibility of a duplicate IP address appearing on your network if the adapter is later restored to service.• Refer to the section <i>Communication Access Registers</i> for a description of the adapter's registers, including how to clear the adapter's stored parameters. <p>Failure to follow this precaution can result in injury or equipment damage.</p>

Remove Operating Power and Disconnect the Adapter

Before removing the adapter, remove the operating power from the I/O base. Then disconnect the Ethernet cable, and remove the adapter from the base.

Install the New Adapter

Mount the new adapter onto the I/O base, following the instructions supplied with the new adapter. Record the new adapter's IEEE Global Address (MAC address), and use it to configure an Internet Protocol address (IP address) for the adapter. Secure the ground screw.

The section *Placing the Adapter into Service* describes how to place the new adapter into service using the Ethernet BOOTP protocol.

Communicating with the Adapter

10

Communication Access Registers

Overview This material describes the Momentum 170ENT11002 (170ENT11000), an adapter that can be connected to any Momentum I/O base to create a functional I/O module.

Description Each adapter contains three groups of registers that enable the application to communicate with the I/O base adapter.
The application accesses the registers to:

- Transfer input or output data at the I/O base adapter's field terminals
- Set or retrieve the adapter's configuration
- Monitor its status

All of the parameters can be accessed as 4XXXX references by MSTR function blocks in the application program.

Communication Adapter Access Registers

ETHERNET NETWORK		STARTING REFERENCE (Hex / Decimal)	LENGTH (16-Bit Words)
	DATA REGISTERS		
←	DATA INPUT (Read Only)	40001 / 400001	Module dependent
→	DATA OUTPUT (Write Only)	40001 / 400001	Module dependent
	CONFIGURATION REGISTERS		
↔	MODULE TIMEOUT (Read or Write)	4F001 / 461441	1
↔	MODULE OWNERSHIP (Read or Write)	4F401 / 462465	6
↔	CONFIG. SAVE/GET IP (Read or Write)	4F411 / 462481	1 on Write 2 on Read
	STATUS REGISTERS		
←	MODULE STATUS (Read Only)	4F801 / 463489	13
←	MODULE ASCII HEADER (Read Only)	4FC01 / 464513	Module dependent

Data Registers

40001 hex — Data Input or Output

Starting reference 40001 is used to address input data from field inputs and output data to field outputs. Data is transferred in the IEC format. Mapping between the controller's data registers and I/O base field terminals is unique to each base, and the mapping is described in the *Momentum I/O Bases User Guide*, 870USE00200.

Configuration Registers

4F001 hex — Outputs Holdup Timeout Value

Reference 4F001 specifies the amount of time that outputs will be held in their current state if they are not updated by a new Modbus TCP/IP Write. If the module's holdup time expires before a new Modbus TCP/IP Write is received, all outputs are set to logical 0 (zero).

The field length is one word. The timeout value is expressed in units of 10 milliseconds. Valid values are either 0 (zero) or a range of 30 (300 milliseconds) through 6000 (60 seconds). The default value is 100 (1 second).

The registers contents can be read using a Modbus Read command.

Note: The value of 0 (zero) in this register indicates an indefinite holdup time, and the outputs will not change if they are not updated by a Modbus TCP/IP Write.

	WARNING
	<p>LOSS OF COMMUNICATION — INDEFINITE HOLDUP TIME</p> <p>If indefinite Holdup Time is selected, and communication is lost between the controller and the Momentum 170ENT11002 (170ENT11000), the I/O outputs will hold last value written until communication is reestablished.</p> <ul style="list-style-type: none"> ● Configure the controller to periodically read the I/O module health (Word 10) of the Module Status Block, register 4F801 hex, of the Momentum 170ENT11002 (170ENT11000) to verify that the communication between the controller and the Momentum 170ENT11002 (170ENT11000) is operational and that the controller is healthy. ● The Module Status Block is described in the Module Status Block Table below. <p>Failure to follow this precaution can result in death, serious injury, or equipment damage.</p>

4F401 hex — Ownership of Write Privilege

When the adapter first receives power, it will give sole write privilege to the first node that writes to it using the Modbus Write command. The adapter maintains an internal 60--second timer for handling the write privilege, and will reserve sole privilege to that node as long as the node continues to write within 60--second intervals to the adapter.

Starting reference 4F401 specifies the IP addresses of up to three more nodes which may concurrently own write privilege to the adapter. A node which currently owns the write privilege may write up to three IP addresses (2words per address) to the adapter starting at 4F401. With those addresses stored, any of those three nodes may then write to the adapter in addition to the original privileged node. This allows up to four nodes to concurrently own write privilege to the adapter.

If writes continue to occur within the 60--second interval from any of the three privileged nodes, no other node may write to the adapter. If the timer is allowed to expire, any node may write to the adapter.

Note that this 60-second Write Privilege timer is separate from the Outputs Holdup timer, and applies only to the write privilege. The 60--second time is a fixed value and is not accessible to the application.

Any node may read the input data or status information from the adapter.

4F411 hex — Configuration Save/Get IP Address

This reference serves a dual purpose, depending on whether the application issues a Modbus TCP/IP Write or a Modbus TCP/IP Read. When the register issues a Modbus TCP/IP Write the register name is Configuration Save, and when the register issues a Modbus TCP/IP Read the register name is Get Current IP Address.

Modbus Write Command: Configuration Save

For a Modbus TCP/IP Write the reference is treated as a one-word register, with the application writing one word of data. The Modbus TCP/IP Write data may consist of a value from 0 (zero) to 7, a bit-masked OR (the Boolean logical "OR").

If a data 1 (one) is written to the reference, the adapter will save its currently assigned IP address to FLASH. If a new initialization occurs and the adapter cannot find a BOOTP server, the adapter will use this saved address.

Note: Any change of the Configuration Save register will cause the adapter to re initialize. This re initialization will occur when saving or clearing the parameters.

The configuration register values for the 4F411 hex register: Modbus TCP/IP Write ONLY.

Register	Register Decimal Value	Register Binary Value	Action
4F411 hex	0	0000	Clears the configuration
	1	0001	Saves the configured IP to FLASH
	2	0010	Saves the three (3) Master IPs addresses to FLASH
	4	0100	Saves the Outputs Holdup Timeout Value to FLASH

Example: If you want to save Outputs Holdup Timeout Value and Save the configured IP to FLASH:

1. Add the register decimal values:
 $1 + 4 = 5$
2. Enter the decimal value **5** into the register
3. The value displays in binary:
 00000101

	CAUTION
	UNINTENDED OPERATION — DUPLICATE IP ADDRESS Having two or more devices with the same IP address can cause unpredictable operation of your network. <ul style="list-style-type: none">● Ensure that this device will receive a unique IP address.● Before removing a 170ENT11002 (170ENT11000) adapter from service, you should first write a logical 0 (zero) into the parameter storage register 4F411 to clear the adapter's stored parameters. This will reduce the possibility of a duplicate address appearing on your network if the adapter is later restored to service.● Refer to the section Communication Access Registers for a description of the 170ENT11002 (170ENT11000) adapter's registers, including how to clear the adapter's stored parameters. Failure to follow this precaution can result in injury or equipment damage.

Modbus Read Command: Get IP Address

For a Modbus Read command the reference is treated as a two-word register, with the application reading two words of data. If the adapter has IP parameters saved in its non-volatile RAM, it will return its current IP address to the Modbus Read command, indicating that it has stored parameters. If IP parameters are not currently saved, the adapter returns all ones (FFFFFFFF hex) to the Read.

Status Registers 4F801 hex — Module Status Block

These registers provide information about the module’s revision level and current operating parameters.

The block’s length is 13 words. The registers can be read by the application, but cannot be written into.

Module Status Block Layout

Reference (hex)	Purpose	Contents
4F801	Length of status block (words)	13 decimal
4F802	I/O module quantity of input words	Module dependent
4F803	I/O module quantity of output words	Module dependent
4F804	I/O module ID number	Module dependent
4F805	Communication Adapter revision number	Format: XR Where: <ul style="list-style-type: none"> ● X = upper 4 bits, always 0000 ● R = lower 12 bits, defining the revision as 3 hex characters. Example: <ul style="list-style-type: none"> ● 100 hex = Rev. 1.00 ● 200 hex = Rev. 2.00
4F806	ASCII header block length (words)	Module dependent
4F807	Last IP address to communicate with this adapter in most recent Modbus transaction (low word of 2 words) See 4F80D.	Node address dependent
4F808	Remaining ownership reservation time	milliseconds
4F809	Remaining outputs holdup time	milliseconds
4F80A	I/O module health	8000 hex = healthy 0000 hex = not healthy
4F80B	I/O module last error value	Module dependent
4F80C	I/O module error counter	Error count 0000 ... FFFF hex
4F80D	Last IP address to communicate with this adapter in most recent Modbus transaction (high word of 2 words) See 4F807.	Node address dependent

4FC01 hex—Module ASCII Header Block

These registers contain an ASCII text description of the module. The registers can be read by the application, but cannot be written into.

The block length depends upon the type of I/O base to which the adapter is connected. The maximum length is 64 bytes of ASCII characters, corresponding to a length of 8 ... 32 words as specified in word 6 of the Module Status Block (at reference 4F806).

The block contains labels to identify quantities of input and output words, and the ID code of the I/O base. You can parse the block contents to extract this information in to your application.

ASCII Characters	Description
Ethernet	Identifies Ethernet Communication Adapter
20 hex (32 decimal)	Space
IEC	Data is transferred with I/O base in IEC format
20 hex (32 decimal)	Space
DIG:	Digital module (ID range: XX00 ... XX7F hex)
EXP:	Expert module (ID range: XX80 ... XXBF hex)
ANA:	Analog module (ID range: XXC0 ... XXFE hex)
20 hex (32 decimal)	Space
Inlen=<i>n</i>	Input words (<i>n</i> = quantity of words, decimal)
20 hex (32 decimal)	Space
Outlen=<i>n</i>	Output words (<i>n</i> = quantity of words, decimal)
20 hex (32 decimal)	Space
ID=0xnⁿⁿⁿ	Module DI code (ⁿⁿⁿⁿ = ID code, hex)

Examples of the ASCII Header Block contents for two I/O bases.

170 ADM 350 00 (Discrete 16-Point Input, 16-Point Output Module)

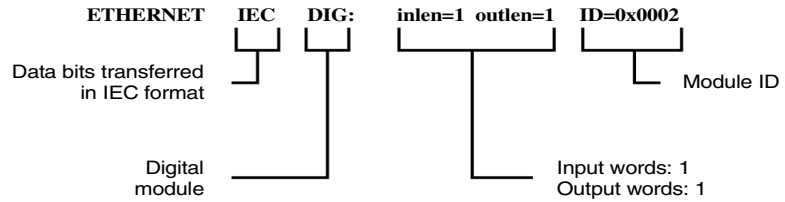

170 AAO 120 00 (Analog 4-Channel Output Module)

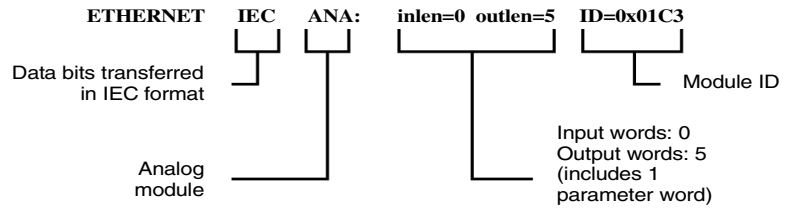

Appendices



At a Glance

Purpose

The appendices provide supplementary reference information for the Momentum 170ENT11001 and the Momentum 170ENT11002 (170ENT11000).

What's in this Appendix?

The appendix contains the following chapters:

Chapter	Chapter Name	Page
A	Specifications - Momentum 170ENT11001 and Momentum 170ENT11002 (170ENT11000)	139
B	IP Parameter Resolution State Table - Momentum 170ENT11001	141
C	Configuration Parameter Resolution State Table - Momentum 170ENT11001	143
D	LED Status Indicators — Momentum 170ENT11001	147
E	Deriving an IP Address from a MAC Address	151
F	Establishing an Active Route — Momentum 170ENT11001	153

Specifications - Momentum 170ENT11001 and Momentum 170ENT11002 (170ENT11000)



Specifications - Momentum 170ENT11001

Overview

This section describes the electrical and environmental specifications and the EMC requirements of the Momentum 170ENT11001.

Compatibility

The communication adapter is compatible to the ATI-interface and will function with all I/O bodies, which operate according to the ATI-interface specification. This product, when mated to an Momentum IO base will behave similarly to an Momentum I/O Base with a Modbus Plus communications adapter.

Agency Approvals

- U.L. 508, 746C, 94.
- IEC 61131-2 (where applicable)
- CSA 22.2 No. 142
- CE Mark
- FM Class 1 Div. 2

Electrical Specifications

ATI-Interface

- Logic supply V_{cc} :5V/+5%/500ma
Max supplied from the I/O body to the interface, according to the ATI-interface specification.
Levels, load, timing according to the ATI-interface specification

Ethernet-Interface

- Compliant with the STP 100 ohm connection.

Electrical Specifications for the Momentum 170ENT11001

Specification	Description
5 V Tolerance	+/- 5%
5 V Current Consumption	200 MA max.; @ < 100uF Capacitive Load

Environmental Specifications

Environmental Specifications for the Momentum 170ENT11001

Specification	Description
Temperature	0 - 60 degrees C. operating -40 - +85 degrees C. storage
Humidity	5 - 95% RH (non-condensing)
Vibration	10 - 57 Hz @ 0.075 mmd.a 57 - 150 Hz @ 1g
Shock	+/- 15 G peak, 11ms, half sine-wave

Network Specification

Network Specification for the Momentum 170ENT11001

Specification	Description
Ethernet Interface	Compliant with STP or UTP 100 ohm connection

EMC Requirements

The module is considered open equipment, which means it may only be used in enclosure. The following tests were performed only with shielded cable.

Standard	Test Description	Application Port	TOP HAT OPEN EQUIPMENT Parameters/Limits
EN 55011	Radiated Interference	Enclosure	Class A
EN50140 / IEC1000-4-3	Radiated RF immunity	Enclosure	80-1000 Mhz 10 V/m
EN50140	Radiated RF impulse immunity	Enclosure	900 Mhz 10 V/m
IEC 1000-4-2 Note	Electrostatic Discharge	Enclosure	8kV Air 4 kV contact
ENV50141/ IEC 1000-4-6 Note	Conducted RF immunity	Comm. Port	.15-80 MHz 10 Vrms
IEC 1000-4-4	Fast Transient Burst	Comm. lines	1 kV cap. clamp
ENV 50142 / IEC1000-4-5	Surges	Earth Port(shield)	2 kV CM
IEC 1131 par 4.7.2	Protective Earth Continuity	Connector to Earth	30 A <0.1 Ω

Note: For Communication ports **pass / fail criteria B** is acceptable.

IP Parameter Resolution State Table - Momentum 170ENT11001

B

IP Parameter Resolution State Table - Momentum 170ENT11001

Overview

This section presents the Momentum 170ENT11001 IP Parameter Resolution State.
IP Parameter Resolution State Table

	Served IP	Stored IP	Agree	IP Fallback Bit	Action) (X = Can not happen)
Role Name Exists (FDR)	1	1	1	1	Use Served
	1	1	0	1	Use Served and Overwrite Stored with Served
	1	1	1	0	Use Served
	1	1	0	0	Use Served and Overwrite Stored with Served
	1	0	1	1	X
	1	0	0	1	X
	1	0	1	0	X
	1	0	0	0	Use Served and Overwrite Stored with Served
	0	1	1	1	X
	0	1	0	1	Use Stored IP and Configuration Parameters
	0	1	1	0	X
	0	1	0	0	SAFE IO mode after 5 min.
	0	0	1	1	X
	0	0	0	1	X
	0	0	1	0	X
0	0	0	0	SAFE IO mode after 5 min.	

	Served IP	Stored IP	Agree	IP Fallback Bit	Action) (X = Can not happen)
No Role Name Exists (Module exhibits ENT11000 behavior)	1	1	1	1	Use Served
	1	1	0	1	Use Served
	1	1	1	0	Use Served
	1	1	0	0	Use Served
	1	0	1	1	X
	1	0	0	1	X
	1	0	1	0	X
	1	0	0	0	Use Served
	0	1	1	1	X
	0	1	0	1	Use Stored
	0	1	1	0	X
	0	1	0	0	Use Stored
	0	0	1	1	X
	0	0	0	1	X
	0	0	1	0	X
0	0	0	0	SAFE IO mode after 5 min.	

The above table is based on Boolean Logic. The following table describes columns two through six.

Legend

Column Name	Explanation
Served IP	Did DHCP/BOOTP respond with valid IP parameters? 1 = Yes 0 = No
Stored IP	Do valid IP parameters exist in the Flash database? 1 = Yes 0 = No
Agree	Do the Served IP and Stored IP parameters agree? 1 = Yes 0 = No If the values of the two parameters are different, the parameters do not agree, and the result is a "No" or 0 (zero).
IP FallBack Bit	Is the IP FallBack Bit set in the Flash database? 1 = Yes 0 = No
Action	Desired action results. X in a column indicates that this condition will be disallowed.

Configuration Parameter Resolution State Table - Momentum 170ENT11001

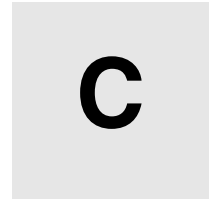

Configuration Parameter Resolution State Table - Momentum 170ENT11001

Overview

This section presents the Momentum 170ENT11001 Configuration Parameter Resolution State.

Configuration Parameter Resolution State Table

	Served Config Parameters	Stored Config Parameters	Agree	Config Fallback Bit	Action) (X = Can not happen)
Role Name Exists (FDR)	1	1	1	1	Use Served Config Parameters
	1	1	0	1	Use Served and Overwrite Stored with Served
	1	1	1	0	Use Served Config Parameters
	1	1	0	0	Use Served and Overwrite Stored with Served
	1	0	1	1	X
	1	0	0	1	X
	1	0	1	0	X
	1	0	0	0	Use Served and Overwrite Stored with Served
	0	1	1	1	X
	0	1	0	1	Use Stored Config Parameters
	0	1	1	0	X
	0	1	0	0	SAFE IO mode
0	0	1	1	X	

	Served Config Parameters	Stored Config Parameters	Agree	Config Fallback Bit	Action) (X = Can not happen)
	0	0	0	1	X
	0	0	1	0	X
	0	0	0	0	SAFE IO mode
No Role Name Exists (Module exhibits ENT11000 behavior)	1	1	1	1	X
	1	1	0	1	X
	1	1	1	0	X
	1	1	0	0	X
	1	0	1	1	X
	1	0	0	1	X
	1	0	1	0	X
	1	0	0	0	X
	0	1	1	1	X
	0	1	0	1	Use Stored Config Parameters
	0	1	1	0	X
	0	1	0	0	Use Stored Config Parameters
	0	0	1	1	X
	0	0	0	1	X
	0	0	1	0	X
0	0	0	0	Factory Default Parameters	

The above table is based on Boolean Logic. The following table describes columns two through 6.

Legend

Column Name	Explanation
Served Config Parameters	Did FDR provide a valid set of Configuration parameters? 1 = Yes 0 = No
Stored Config Parameters	Do valid Configuration parameters exist in Flash? 1 = Yes 0 = No
Agree	Do the Served IP and Stored IP parameters agree? 1 = Yes 0 = No If the values of the two parameters are different, the two parameters do not agree, and the result is a "No" or 0 (zero).
Config FallBack Bit	Is the Config FallBack Bit set in the Flash database? 1 = Yes 0 = No
Action	Desired action results. X in a column indicates that this condition will be disallowed.

LED Status Indicators — Momentum 170ENT11001

D

LED Status Indicators

Overview

This section describes the LED Status indicators for the Momentum 170ENT11001 Ethernet Communication Adapter.

Understanding the LED Status Indicators

The Momentum 170ENT11001

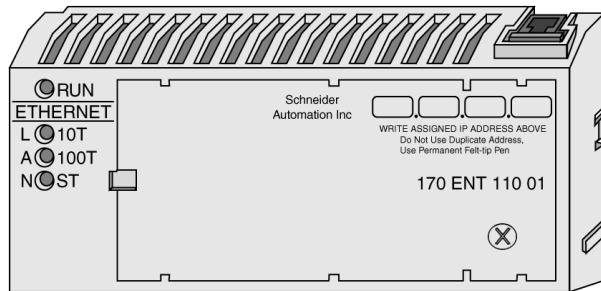

Four LED indicator lights provide continuous operating information about the Momentum 170ENT11001 and its connection to the network.

LED	Light Name	Color	Description
RUN	Run Mode Indicator	Green	Indicates the module's operating state
10T	LAN ACT-10 Indicator	Green*	Indicates 10 Mbps network activity Please see the note below.
100T	LAN ACT-100 Indicator	Amber*	Indicates 100 Mbps network activity Please see the note below.
ST	LAN Status Indicator	Green	Indicates the interface status

Note: *If using a 3Com hub, you may observe that the 10Base-T is amber, and the 100Base-T is green, or the reverse of the table above.

Interpreting Indicator and Adapter Status

The Run Mode and LAN status LED indicators provide continuous feedback as the the status of the run mode and the LAN.

RUN Indicator LED	LAN ST Indicator LED	Status
On (Steady)	On	Normal operation: Power is present from I/O base, and the adapter is ready for network communication. Adapter detects network activity. The flashing rate of the appropriate LAN ACT LED indicates the amount of activity. LAN ACT LED may appear as steady ON if network activity is high. Indicator is ON continuously during normal operation.
Off	Off	Interface is not powered
N/A	Fast Flash	Normal Ethernet initialization during power-up.
N/A	3 Flashes, long Off	Indicates no link pulse detected. The network cable is not connected or is defective. The Hub/Switch is not functioning correctly or not correctly configured.
N/A	4 Flashes, long Off	Duplicate IP Address exists.
N/A	5 Flashes, long Off	No IP Address: The adapter is attempting to obtain an IP Address from a BOOTP server.
N/A	6 Flashes, long Off	SAFE I/O mode - I/O is disabled. Device using Default IP Address.
N/A	7 Flashes, long Off	FDR server update failure - I/O is still running. You should check FDR server and/or cable connections to FDR server. The FDR server update failure condition will clear itself once communication to the FDR server is restored.
N/A	8 Flashes, long Off	SAFE I/O mode - I/O is disabled. Device using Served IP Address.

Note: For detailed information on any of these blink codes refer to the Web available system log, which is detailed on *Accessing the Momentum 170ENT11001 Diagnostics*, p. 48.

Three of the four indicator LEDs on the Momentum 170ENT11001 show operating status. The following tables describe the LAN ACT-10 Indicator and LAN ACT-100 Indicator status, the LAN ST Indicator status, and the Kernel Mode status.

The LAN ACT-10 and LAN ACT-100 status indicators provide continuous feedback on network activity.

LAN ACT-10 Indicator LEDs	LAN ACT-100 Indicator LEDs	Status
On (Flashes)	On (Flashes)	The appropriate LAN ACT LED will blink with each packet transmitted or received.
Off	Off	Adapter is not detecting any network activity.

The LEDs provide feedback about the Kernel mode status

RUN Indicator LED	LAN ST Indicator LED	Status
2 Flashes, long Off	N/A	Reserved for later use.
3 Flashes, long Off	N/A	Reserved for later use.
4 Flashes, long Off	N/A	No MAC Address: The adapter's MAC address is not set. An internal hardware problem exists.
5 Flashes, long Off	N/A	Reserved for later use
6 Flashes, long Off	N/A	The adapter's internal executive program has started, but cannot initialize the I/O base.
7 Flashes, long Off	N/A	The adapter does not have a valid executive program.
8 Flashes, long Off	N/A	The adapter's executive program has failed during execution.
9 Flashes, long Off	N/A	I/O Base failed during execution.

Note: For detailed information on any of these blink codes refer to the Web available system log, which is detailed on *Accessing the Momentum 170ENT11001 Diagnostics*, p. 48.

Deriving an IP Address from a MAC Address



Deriving an IP Address from a MAC Address

Overview

This section describes the process of deriving an IP address from a MAC address and the times when you may need to derive the IP address.

Getting an IP Address from a MAC Address

Note: All Ethernet devices are assigned a unique ID. Therefore, your adapter was assigned an IP address at the Schneider factory. That IP address is derived from a MAC address.

The MAC address, or IEEE Global Address, is stored as hex. The address appears on the outside of the adapter. As stated, each MAC address is unique. The address on the label below is one unique address and is the address for the adapter displayed below. Your adapter will have a different address.



To convert those hex numbers into decimal numbers, follow these steps:

1. There are six pairs of hex values displayed in the address above. Ignore the first two pairs, 00 and 00.
2. Identify a pair, for example "54."
3. Multiply the first number (5) by 16. $5 \times 16 = 80$
4. Add the second number (4). $80 + 4 = 84$.

There are many sources for converting hex numbers to decimal numbers. We recommend searching on the World Wide Web or using the Windows calculator in Scientific mode.

This table converts the hex pairs in the IEEE Global Address (MAC address) above into a decimal number which becomes one element of an IP address.

Hex pair	Decimal Conversion
54 $5 \times 16 = 80 + 4 = 84$	84
10 $1 \times 16 = 16 + 0 = 16$	16
2D $2 \times 16 = 32 + 13 = 45$ D = 13 in hex	45
11 $1 \times 16 = 16 + 1 = 17$	17

The IP address of the adapter above is 84.16.45.17.

Establishing an Active Route — Momentum 170ENT11001



Establishing an Active Route — Momentum 170ENT11001

Overview

The following information describes how to assign IP address parameters.

Establishing the Active Route

To set the default IP address using your PC, set up an active route from your PC. To do this with either Windows 95/98/2000/ME/XP or Windows NT, use the following procedure.

Step	Action																				
1	Be sure the Momentum 170ENT11001 or Momentum 170ENT11000 module is running.																				
2	Obtain the default IP address of the adapter.																				
3	Open an MS-DOS Window.																				
4	Print the currently active routes by typing : C:>route PRINT																				
5	Add an active route by typing: C: \>route ADD 84.0.0.0 MASK 255.0.0.0 205.217.193.205 The result is that Windows 95/98/ NT will now talk to any address that <ul style="list-style-type: none"> ● Starts with an 84 ● Connects directly to a hub or switch directly accessible to your machine ● Can be seen by the route/gateway specified 																				
6	Confirm that there is a new entry in the active route table by typing: C: >route PRINT The following figure confirms that the new entry was added to the active route table. <div style="border: 1px solid black; padding: 10px; margin: 10px 0;"> <p>Active Routes:</p> <table style="width: 100%; border-collapse: collapse;"> <thead> <tr> <th style="text-align: left;">Network Address</th> <th style="text-align: left;">Netmask</th> <th style="text-align: left;">Gateway Address</th> <th style="text-align: left;">Interface</th> <th style="text-align: left;">Metric</th> </tr> </thead> <tbody> <tr> <td>0.0.0.0</td> <td>0.0.0.0</td> <td>205.217.193.250</td> <td>205.217.193.205</td> <td>1</td> </tr> <tr> <td>84.0.0.0</td> <td>255.0.0.0</td> <td>205.217.193.205</td> <td><u>205.217.193.205</u></td> <td>1</td> </tr> <tr> <td>127.0.0.0</td> <td>255.0.0.0</td> <td>127.0.0.1</td> <td><u>127.0.0.1</u></td> <td>1</td> </tr> </tbody> </table> </div>	Network Address	Netmask	Gateway Address	Interface	Metric	0.0.0.0	0.0.0.0	205.217.193.250	205.217.193.205	1	84.0.0.0	255.0.0.0	205.217.193.205	<u>205.217.193.205</u>	1	127.0.0.0	255.0.0.0	127.0.0.1	<u>127.0.0.1</u>	1
Network Address	Netmask	Gateway Address	Interface	Metric																	
0.0.0.0	0.0.0.0	205.217.193.250	205.217.193.205	1																	
84.0.0.0	255.0.0.0	205.217.193.205	<u>205.217.193.205</u>	1																	
127.0.0.0	255.0.0.0	127.0.0.1	<u>127.0.0.1</u>	1																	
7	Remove an active route by typing: C: \>route DELETE 84.0.0.0																				
8	Verify that a connection is made by typing: C: \>ping 84.0.0.2 The following figure shows that the connection is verified. <div style="border: 1px solid black; padding: 10px; margin: 10px 0;"> <pre>Reply from 84.0.0.2: bytes=32time=1msTTL=32 Reply from 84.0.0.2: bytes=32time=1msTTL=32 Reply from 84.0.0.2: bytes=32time=1msTTL=32 Reply from 84.0.0.2: bytes=32time=1msTTL=32</pre> </div>																				

Specifying Address Parameters

Consult your system administrator to obtain a valid IP address and an appropriate gateway and a subnet mask, if required.

Glossary

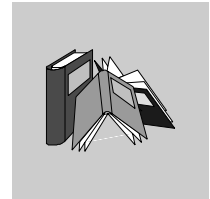

!

- 100Base-T** A networking standard that supports data transfer rates up to 100 Mbps (100 megabits per second). 100BASE-T is based on the older Ethernet standard. Because it is 10 times faster than Ethernet, it is often referred to as Fast Ethernet. Officially, the 100BASE-T standard is IEEE 802.3u
- 10Base-T** One of several adaptations of the Ethernet (IEEE 802.3) standard for Local Area Networks (LANs). The 10Base-T standard (also called Twisted Pair Ethernet) uses a twisted-pair cable with maximum lengths of 100 meters. Cables in the 10Base-T system connect with RJ-45 connectors. A star topology is common with 12 or more computers connected directly to a hub or concentrator. The 10Base-T system operates at 10 Mbps and uses baseband transmission methods
-

A

- ACK** Acknowledgement
- ARP** Address Resolution Protocol. A network layer protocol used to determine the physical address which corresponds to the IP address for a host on the network. ARP is a sub-protocol which operates under TCP/IP.
- ASN.1** Abstract Syntax Notation. Grammar used to define a protocol (OSI scope)
-

B

- block** A block consists of two or more registers.
- BOOTP** BOOTstrap Protocol. A protocol used at power-up in order to get an IP address which is provided by a BOOTP server and is based on the module's MAC address.
- bps** Bits per second.
- bridge** A device that connects two or more physical networks which use the same protocol. Bridges read frames and decide whether to transmit or block them based on their destination address.
-

C

- client** A computer process requesting service from other computer processes.
- Concept** A software package that facilitates controller configuration.
-

D

- default gateway** The IP address of the network or host to which all packets addressed to an unknown network or host are sent. The default gateway is typically a router or other device.
- DHCP** Dynamic Host Configuration Protocol. An improved version of BOOTP.
- DHCP Client** Host on the network obtaining its configuration from a DHCP Server.
- DHCP Server** Server providing configuration parameters to a DHCP Client.
- DNS** Domain Name System. A protocol within TCP/IP used to find IP addresses based on host names
-

F

FactoryCast	An embedded Web server which the user customizes, permitting user access to controller diagnostics and Ethernet configuration.
FDR	Faulty Device Replacement
field	A logical grouping of contiguous bits that convey one kind of information, such as the start or end of a message, an address, data, or an error check.
FLASH	Non volatile memory
frame	A group of bits which form a discrete block of information. Frames contain network control information or data. The size and composition of a frame is determined by the network technology being used.
framing types	Two common framing types are Ethernet II and IEEE 802.3SNAP.
FTP	File Transfer Protocol. The protocol (over TCP) used to read or write a file into a remote station (the FTP server side).
full duplex	

G

gateway	A device which connects networks with dissimilar network architectures and which operates at the Application Layer. This term may refer to a router.
----------------	--

H

half duplex	(HDX) A method of data transmission capable of communication in two directions, but only one direction at a time.
host	A node on a network.

hostname	A domain name given to a specific computer on a network and used to address that computer.
HTTP	A domain name given to a specific computer on a network and used to address that computer.
hub	A device which connects a series of flexible and centralized modules to create a network.

I

I/O Drop	One or two (depending on the system type) Remote I/O Channels consisting of a fixed number of I/O points.
I/O Map	An area in the controller configuration memory used to map input and output points. Previously called traffic cop.
I/O Scan	A procedure the processor follows to monitor inputs and control outputs.
I/O Scan List	A configuration table which identifies the targets with which repetitive communication is authorized.
I/O scanner	Software component which is in charge of scanning Ethernet based Momentum IO in order to get inputs and set outputs.
ICMP	Internet Control Message Protocol. A protocol within TCP/IP used to report errors in datagram transmission.
IEEE Global Address	A unique identifier assigned to every Ethernet device Also called the MAC Address. This is the hardware address of the device. The address is assigned at the factory.
IP	Internet Protocol. A common network layer protocol. IP is most often used with TCP.
IP Address	Internet Protocol Address. A 32-bit address assigned to hosts using TCP/IP.

L

layer	In the OSI model, a portion of the structure of a device which provides defined services for the transfer of information.
--------------	---

Legacy In the sense of network communication: Existing Components (PLC products or Momentum 170ENT11000x.) that do not provide special (hardware) support for Control Intranet.

M

MAC Address Media Access Control address. The hardware address of a device. A MAC address is assigned to an Ethernet TCP/IP module in the factory. The MAC address is also called the IEEE Global Address.

MBAP Modbus Application Protocol

MIB Management Information Base. Database that holds the configuration of a SNMP enabled device.

Modbus A serial communication protocol that allows Modicon controllers with intelligent terminals, I/O, Motor Drivers, other equipment, and computers to communicate over a common carrier or dedicated lines.

Modbus TCP/IP A communication protocol that sits on the Ethernet protocol layer.

MSTR A special instruction that uses ladder logic to read and write controller information.

MSTR block A function block in ladder logic that allows communication on various networking mediums.

N

N_PDU Protocol Data Unit exchanged at layer N level (OSI model)

NDDS Network Data Delivery Services.

network Interconnected devices sharing a common data path and protocol for communication.

node An addressable device on a communications network.

NOET An acronym for the Schneider Electric application: Network Options Ethernet Tester

NOK An acronym that appears on some Web pages and may indicate that the system is operating incorrectly. Schneider Electric recommends immediate diagnosis of the situation and determine the cause for the message appearing.

O

OIT / OID Object Information True / Object ID (identify OIT) Contain databases managing SNMP (MIBs)

OSI model Open System Interconnection model. A reference standard describing the required performance of devices for data communication. Produced by the International Standards Organization.

P

packet The unit of data sent across a network.

PING Packet Internet Groper. A program used to test whether a destination on a network can be reached.

PLC Programmable Logic Controller

port An access point for data entry or exit within a host using TCP services.

port 502 The well-defined port, as defined by the Internet Assigned Numbers Authority (IANA), for Modbus TCP/IP communications as described in the RFC 1060.

port 80 The well-defined port, as defined by the Internet Assigned Numbers Authority (IANA), that is used for world wide for HTTP traffic as described in the RFC 1060.

protocol Describes message formats and a set of rules used by two or more devices to communicate using those formats.

R

- repeater** A device that connects two sections of a network and conveys signals between them without making routing decisions or filtering packets.
- router** A device that connects two or more sections of a network and allows information to flow between them. A router examines every packet it receives and decides whether to block the packet from the rest of the network or transmit it. The router will attempt to send the packet through the network by the most efficient path.
-

S

- Safe I/O** I/O communication between the adapter and I/O base is disabled. The outputs go to their reset state.
- server** Provides services to clients. This term may also refer to the computer on which the service is based.
- SNMP** Simple Network Management Protocol
- socket** The association of a port with an IP address, serving as an identification of sender or recipient.
- stack** The software code which implements the protocol being used. In the case of the NOE modules it is TCP/IP.
- STP** Shielded Twisted Pair. A type of cabling consisting of several strands of wire surrounded by foil shielding, twisted together.
- subnet** A physical or logical network within an IP network, which shares a network address with other portions of the network.
- subnet mask** Shielded Twisted Pair. A type of cabling consisting of several strands of wire surrounded by foil shielding, twisted together.

switch A network device which connects two or more separate network segments and allows traffic to be passed between them. A switch determines whether a frame should be blocked or transmitted based on its destination address. Schneider Electric recommends that you use switches in your automation network.

T

TCP Transmission Control Protocol.

TCP/IP Transmission Control Protocol/Internet Protocol. A protocol suite consisting of the Transmission Control Protocol and the Internet Protocol; the suite of communications protocols on which the Internet is based.

U

URL Uniform Resource Locator. The network address of a file.

W

Web Worldwide interconnection of stations based on Internet protocols. The most famous one is HTTP (Web server).

WWW World Wide Web. A hypertext-based, distributed information system in which clients and servers are freely available.

Index



Numerics

12-pin connectors, 22
170ENT11000, 116
170ENT11001, 15
170ENT11002, 116
802.3SNAP, 125

A

agents, 86
 FDR, 78
Apply buttons, 56
ASN.1, 88

B

blocks, 69
 ASCII header, 135
 MSTR, 62
 status, 134
booting up
 out-of-the-box, 30
 with default IP, 35
 with FDR, 33
 with saved IP, 34
 with served IP, 34

C

ConfigFallback flags, 56
Configuring, 91

customer support, 42

D

Duplicate Address Hazard, 126

E

error codes
 Ethernet testers, 110
 MSTR block, 110
Ethernet module
 Network Options Ethernet Tester, 100
Ethernet tester, 101, 103
 Installing, 100
 reading registers, 108
 requirements, 101
 statistics, 106
 writing registers, 109

F

faulty device replacement (FDR), 72

G

GetRequests, 90
GETs, 92
Groupe_Schneider (3833), 86

I

indicator lights, 121, 147
IP addresses, 153
 serving, 30
IPFallback flags, 51

J

Java loops, 119

L

labels
 fill-in, 27
 IEEE Global Address, 123, 151
 MAC Address, 151
 MAC address, 123
logical names, 73

M

managers, 86
 FDR, 78
MIBs, 86
Momentum 170ENT11000, 116
Momentum 170ENT11001, 15
Momentum 170ENT11002, 116
MSTR blocks, 62, 129

O

object identifiers, 90
OIDs, 90
open equipment, 24
outputs holdup timeout values, 65

P

parameters
 resolution, 76, 141, 143
parsing applications, 70, 135
passwords
 configuration, 51
 Web Access, 40
private MIBs, 86, 92

R

register blocks, 69
registers
 ASCII header, 70
 configuration, 65
 data, 64, 130
 internal, 62
 Outputs Holdup Timeout Value, 131
 Ownership of Write Privilege, 66, 131
 Reservation Time, 66
 system status, 69, 134
reservation times, 66
RoleNames, 33, 52, 73
 valid, 73

S

safe I/O mode, 75, 79
Save buttons, 56
SetRequests, 90
SETs, 92
Simple Network Management Protocol (SNMP), 86, 90
statistics
 Collision errors, 106
 CRC errors, 107
 Framing errors, 107
 IP Address, 106
 Late Collision, 107
 Lost Carrier, 107
 MAC Address, 106
 Memory errors, 107
 Missed packet errors, 106
 Network Interface Restart count, 107
 Overflow errors, 107
 Receive buffer errors, 107
 Receive Interrupts and Transmit Interrupts, 106
 Silo Underflow, 107
 Total Transaction Count, 106
 Transmit buffer errors, 107
 Transmit Limit Retries, 107
 Transmit timeout errors, 106

subtrees

- Equipment Profile, 96
- port 502 messaging, 95
- Transparent Factory Ethernet, 94
- Web, 96

T

- traps, 97

W**Web pages**

- Configure Momentum I/O, 47
- Contact Schneider Electric, 42
- Current Communication Adapter Configuration, 54
- Current IP Configuration, 51
- Current SNMP Configuration, 57
- Momentum I/O Diagnostics, 49
- Momentum I/O Properties, 45
- Momentum I/O Web Server, 41

